

# Los Angeles Valley College

Measure J Utility Master Plan

April 26, 2010



*(Page Intentionally Left Blank)*

<u>TABLE OF CONTENTS</u>	<u>PAGE</u>
<b>EXECUTIVE SUMMARY</b>	<b>1</b>
0.1: Introduction	
0.2: Project Background and Scope	
0.3: Utility Mapping	
0.4: Report Objective	
0.5: Report Overview	
0.6: Existing and Proposed Building Improvements	
0.7: Construction Phasing	
<u>TABLES</u>	
ES-1: Existing Buildings	2
ES-2: Proposed Buildings	2
ES-3: Proposed Building Construction Schedule	3
ES-4: Construction Phasing	3
<u>FIGURES</u>	
0a - Location Map	5
0b - Overall Campus Map – Existing Building Layout	7
0c - Overall Campus Map – Building Demolition Plan	9
0d - Overall Campus Map –Future Building Layout	11
0e - Measure J Master Plan Summary	13
0f - Draft Implementation Schedule	15
0g - Phasing Diagram	17
<b>SECTION 1 – SANITARY SEWER SYSTEM</b>	<b>19</b>
1.1: System Description	
1.2: Methodology	
1.3: Analysis of Existing System	
1.4: Analysis of Future Needs	

<u>TABLE OF CONTENTS</u>	<u>PAGE</u>
1.5: Findings and Recommendations	
<u>TABLES</u>	
1-1: Existing Campus Sanitary Sewer Flow Allocation	25
1-2: Existing Sanitary Sewer Model Data	27
1-3: Proposed Campus Sanitary Sewer Flow Allocation	33
1-4: Proposed Sanitary Sewer Model Data	35
1-5: Sanitary Sewer Flow Summary	15
<u>FIGURES</u>	
1a - Existing Utility Map – Sanitary Sewer	21
1b - Future Conditions Utility Map – Sanitary Sewer	23
1c - Existing Sanitary Sewer Pipe and Node Key Map	41
1d - Existing Sanitary Sewer – Pipe and Node Map Area A	43
1e - Existing Sanitary Sewer – Pipe and Node Map Area B	45
1f - Existing Sanitary Sewer – Pipe and Node Map Areas C and D	47
1g - Existing Sanitary Sewer – Pipe and Node Map Area E	49
1h - Existing Sanitary Sewer – Pipe and Node Map Areas F, G and J	51
1j - Existing Sanitary Sewer – Pipe and Node Map Areas H and K	53
1k - Existing Sanitary Sewer – Pipe and Node Map Area L	55
1l - Existing Sanitary Sewer – Pipe and Node Map Areas M and N	57
1m - Existing Sanitary Sewer – Pipe and Node Map Area P	59
1n - Proposed Sanitary Sewer – Pipe and Node Map Area A	61

<u>TABLE OF CONTENTS</u>	<u>PAGE</u>
1p - Proposed Sanitary Sewer – Pipe and Node Map Area C	63
1q - Proposed Sanitary Sewer – Pipe and Node Map Area E	65
1r - Proposed Sanitary Sewer – Pipe and Node Map Areas F and J	67
1s - Proposed Sanitary Sewer – Pipe and Node Map Areas H and K	69
1t - Proposed Sanitary Sewer – Pipe and Node Map Area P	71
<b>SECTION 2 – STORM DRAIN SYSTEM</b>	<b>73</b>
2.1: Existing System Description	
<u>FIGURES</u>	
2a - Existing Utility Map – Storm Drain	75
<b>SECTION 3 – WATER SYSTEM</b>	<b>77</b>
3.1: System Description	
3.2: Methodology	
3.3: Analysis of Existing System	
3.4: Analysis of Future Needs	
3.5: Findings and Recommendations	
<u>TABLES</u>	
3-1: Historical Domestic Water Use	77
3-2: Existing Water Distribution Model Output Results	83
3-3: Proposed Water Distribution Model Output Results	89

<u>TABLE OF CONTENTS</u>	<u>PAGE</u>
<u>FIGURES</u>	
3a - Existing Utility Map – Water Distribution	79
3b - Future Conditions Utility Map – Water Distribution	81
3c - Existing Water Distribution – Pipe and Node Map	95
3d - Proposed Water Distribution – Pipe and Node Map	97
<b>SECTION 4 – IRRIGATION WATER SYSTEM</b>	<b>99</b>
4.1: System Description	
4.2: Methodology	
4.3: Analysis of Existing System	
4.4: Analysis of Future Needs	
4.5: Findings and Recommendations	
<u>TABLES</u>	
4-1: Historical Irrigation Water Use	99
4-2: Existing Irrigation Water Distribution Model Output Results	105
4-3: Proposed Irrigation Water Distribution Model Output Results	109
<u>FIGURES</u>	
4a - Existing Utility Map – Irrigation Water Distribution	101
4b - Future Conditions Utility Map – Irrigation Water Distribution	103
4c - Existing Irrigation Water Distribution – Pipe and Node Map	113
4d - Proposed Irrigation Water Distribution – Pipe and Node Map	115

<u>TABLE OF CONTENTS</u>	<u>PAGE</u>
<b>SECTION 5 – ELECTRICAL SYSTEM</b>	<b>117</b>
5.1: System Description	
5.2: Methodology	
5.3: Analysis of Existing System	
5.4: Analysis of Future Needs	
5.5: Findings and Recommendations	
<u>TABLES</u>	
5-1: Installed Capacities by Substation / Feeders	118
5-2: Installed Capacities / Demand of Future Facilities 2010 to 2014	120
5-3: Installed Capacities by Substation / Feeders	123
<u>FIGURES</u>	
5a-5d - Existing Conditions Utility Map – Electrical	125-131
5e - Existing Conditions Electrical System – Single Line Diagram	133
5f-5i - Future Conditions Utility Map – Electrical	135-141
5j - Future Conditions Electrical System – Single Line Diagram	143
5k - Future Conditions Electrical System – Single Line Diagram Feeder H	145
<b>SECTION 6 – TELECOMMUNICATIONS SYSTEM</b>	<b>147</b>
6.1: System Description	
6.2: Methodology	
6.3: Analysis of Existing System	
6.4: Analysis of Future Needs	
6.5: Findings and Recommendations	

<u>TABLE OF CONTENTS</u>	<u>PAGE</u>
<u>FIGURES</u>	
6a-6d - Existing Conditions Utility Map – Telecomm	149-155
6e-6h - Future Conditions Utility Map – Telecomm.	157-163
6j - Future Conditions Utility Map – Copper Wiring Diagram	165
6k - Future Conditions Utility map – Infrastructure IT / Data Conduit Diagram	167
<b>SECTION 7 – NATURAL GAS SYSTEM</b>	<b>169</b>
7.1: System Description	
7.2: Methodology	
7.3: Analysis of Existing System	
7.4: Analysis of Future Needs	
7.5: Findings and Recommendations	
<u>TABLES</u>	
7-1: Existing Gas Demand Loads	170
7-2: Future Gas Demand Loads	174
7-3: Existing / Future Gas Demand Loads	176
<u>FIGURES</u>	
7a-7d – Existing Conditions Utility Map – Natural Gas	179-185
7e-7h - Future Conditions Utility Map – Natural Gas	187-193
<b>SECTION 8 – CHILLED WATER SYSTEM</b>	<b>195</b>
8.1: System Description	
8.2: Methodology	
8.3: Analysis of Existing System	
8.4: Analysis of Future Needs	
8.5: Findings and Recommendations	

<u>TABLE OF CONTENTS</u>	<u>PAGE</u>
<u>FIGURES</u>	
8a-8d – Existing Conditions Utility Map – Chilled Water	199-205
8e-8h - Future Conditions Utility Map – Chilled Water	207-213
<b>SECTION 9 – HOT WATER SYSTEM</b>	<b>215</b>
9.1: System Description	
9.2: Methodology	
9.3: Analysis of Existing System	
9.4: Analysis of Future Needs	
9.5: Findings and Recommendations	
<u>FIGURES</u>	
9a-9d – Existing Conditions Utility Map – Hot Water	219-225
9e-9h - Future Conditions Utility Map – Hot Water	227-233
<b>SECTION 10 – CENTRAL PLANT EXPANSION</b>	<b>235</b>
10.1: System Description	
10.2: Estimated Loads and Capacities	
10.3: Findings and Recommendations	
<u>TABLES</u>	
10-1: Chilled Water System	235
10-2: Chilled Water Pumping System	235
10-3: Chilled Water Condenser Water System	235
10-4: Chilled Water Cooling Tower	235
10-5: Condenser Water Pumping System	236
10-6: Absorption Chiller System	236
10-7: Absorption Chiller Pumping System	236
10-8: Absorption Chiller Condenser Water System	236

<u>TABLE OF CONTENTS</u>	<u>PAGE</u>
10-9: Absorption Chiller Cooling Tower	236
10-10: Glycol Chiller System	236
10-11: Glycol Chiller Pumping System	237
10-12: Glycol Chiller TES System	237
10-13: Glycol Chiller Heat Exchanger	237
10-14: Glycol Chiller Condenser Water Pumping System	237
10-15: Glycol Chiller Cooling Tower	237
10-16: Heating Hot Water System	238
10-17: Heating Hot Water Pumping System	238
10-18: Absorber Hot Water Generator System	238
10-19: Absorber Hot Water Generator Pumping System	238
10-20: Solar Hot Water Storage Tank System	239
10-21: Solar Hot Water Storage Tank Pumping System	239
10-22: Chilled Water System Capacity	239
10-23: New Proposed Central Plant Cooling Production Capacity	240
10-24: Heating Hot Water System Capacity	240
<b>APPENDIX A</b>	<b>243</b>
24"x36" Existing Utility Composite Map	
<b>APPENDIX B</b>	<b>247</b>
Data Collection Log	
<b>APPENDIX C</b>	<b>255</b>
Los Angeles Department of Water and Power (LADWP) Water Service Data	
<b>APPENDIX D</b>	<b>263</b>
LAVC Measure J Utility Master Plan – Review Workshop Meeting Notes, April 8, 2010 and April 14, 2010	

<u>TABLE OF CONTENTS</u>	<u>PAGE</u>
<b>APPENDIX E</b>	<b>271</b>
Sanitary Sewer Pothole Report	

*(Page Intentionally Left Blank)*

## EXECUTIVE SUMMARY

### 0.1 INTRODUCTION

Located in the Valley Glen neighborhood in the City of Los Angeles, Los Angeles Valley College (LAVC) consists of approximately 685,000 gross square-feet. LAVC is one the largest of the nine Los Angeles Community College District (LACCD) campuses. Based on information provided in the Addendum to Valley College Master Plan Program EIR (dated December 20, 2006), LAVC currently had a student population of 11,920 full-time equivalent (FTE) in 2006 and student enrollment is expected to continue to increase by approximately 3% per year. To serve the expanding student body, a number of new academic and support buildings have been identified in the Los Angeles Valley College Master Plan (Steinberg Architects, September 10, 2009), identified herein as the Prop. J Master Plan.

### 0.2 PROJECT BACKGROUND AND SCOPE

With the passage of Measure J in November 2008, Psomas has been asked to prepare utility mapping and capacity studies based on record information of the original campus buildings and infrastructure, and constructed Bond A/AA infrastructure. Scope of work includes research, map and evaluate the existing campus utility infrastructure, and provide recommendations for improvements to each of the utility systems based on future development shown in the Prop. J Master Plan.

The utility research was completed via coordination with the College Project Manager (CPM) to collect record documentation regarding the location of underground utilities throughout the LAVC Campus. The Data Collection Log provided in Appendix B, attached herein summarizes the building and utility record information collected by Psomas. Psomas also collected design submittals from Bond A/AA projects either currently under construction or in design when utility asbuilt information was not available. The provided design submittals have been used as reference documents in lieu of unavailable utility record data.

Scope of work also includes preparing an aerial topography of the LAVC campus and surface indications survey reflecting all the existing utility structures visible from the ground. The aerial and survey were completed and submitted to the CPM as a separate package.

### 0.3 UTILITY MAPPING

Existing utility information included herein is based upon drawings and information supplied by the CPM and various designers and contractors as outlined in the Data Collection Log provided in Appendix B. Information reflected in the aerial topography and surface indication survey (both prepared by Psomas) was used to identify locations of the existing utility systems.

Using the provided information, Psomas prepared individual utility base maps for the following existing utility systems:

- Sanitary Sewer
- Storm Drain
- Domestic and Fire Water
- Irrigation Water
- Electrical
- Telecommunications
- Natural Gas
- Chilled Water
- Hot Water

A set of 30"x42", 40-scale Existing Utility Plans illustrating the utility mapping completed for each utility system have been prepared under separate cover. 24"x36", 80-scale, color Existing Utility Composite Maps are provided in Appendix A of this report. The utility alignments shown in the Existing Utility Plans, Appendix A and report figures included herein represent the most practical layout based on all information available. Changes in building layouts, locations, and miscellaneous other conditions may require alignment or utility size revisions.

Specific areas of the campus sanitary sewer system which were not identifiable by the aerial topography or surface indications survey were located by subsurface investigation. A copy of the Sanitary Sewer Pothole report is provided in Appendix E of this report and the vertical information was used to assist with the utility mapping.

As a sub consultant to Psomas, P2S Engineering has assisted with the preparation of the utility mapping for the existing electrical, telecommunication, natural gas, chilled water and hot water utility systems.

### 0.4 REPORT OBJECTIVE

The objective of the LAVC Measure J Utility Master Plan is to evaluate the existing utility systems currently servicing the LAVC facilities and make recommendations as necessary to upgrade and modify the utility systems to support the future development as proposed by the Prop. J Master Plan. The following existing utility systems shall be considered in this report:

- Sanitary Sewer
- Domestic and Fire Water
- Irrigation Water
- Electrical
- Telecommunications
- Natural Gas
- Chilled Water
- Hot Water

Supporting Psomas as a sub consultant in this report, P2S Engineering has performed assessments of the electrical, telecommunications,

natural gas, chilled water, and hot water systems. P2S has also completed an evaluation of the LAVC Central Plant system.

### 0.5 REPORT OVERVIEW

The various utility systems discussed within this report are broken into discipline specific sections. Corresponding figures and supporting data tables are located at the end of each section.

The following information for each utility system is presented in discipline specific sections, Section 1 through 10, of this report.

- Description of the existing utility system, including existing conditions and identified problems. Information on each utility system was obtained through field surveys, existing documents and record data, and discussions with campus facilities staff knowledgeable of specific utility systems.
- Description of methodology for analyzing the utility system for present conditions and to accommodate future growth.
- Analysis of the existing and proposed utility systems.
- Description of how each utility system is positioned to handle future growth as identified in the Prop. J Master Plan.
- Concept level recommendations to accommodate present and future needs of the campus and put forth to capture cost and budget.
- Figures illustrating at a concept level the existing utility system layout based on the utility mapping and existing conditions shown in the aerial topography.
- Figures illustrating at a concept level the proposed utility alignments based on future conditions presented in the Prop. J Master Plan. For accuracy, the aerial topography is shown in the background of the utility system figures included herein.

Section 10 discusses the existing campus Central Plant, presents an analysis of future needs and provides recommendations for future expansion.

The existing storm drain system is discussed in Section 2; however analysis of the existing system and recommendations for improvements to support the Prop. J Master Plan shall be covered under the Measure J Storm Water Master Plan, to be developed under a separate contract.

The Draft Measure J Utility Master Plan, dated March 8, 2010 was reviewed during two review workshops with Campus Facilities, the CPM, and Campus IT Department on April 8, 2010 and April 14 2010. The findings and recommendations presented herein have been updated to reflect information provided during the review workshops. A copy of the meeting notes summarizing discussions during the review workshops are located in Appendix D of this report.

Based on collaborative discussions during the review workshops, priority levels have been assigned to the recommendations described in each section of this report. Priority levels have been created to assist the CPM and Campus Facilities allocate Measure J budget to individual infrastructure projects. The recommendations are categorized into the following three priority levels:

PRIORITY LEVEL	DESCRIPTION
Priority 1	Required for implementation of Measure J development
Priority 2	Strongly recommended (not required)
Priority 3	Recommended to provide added benefit to the campus infrastructure system.

As a sub consultant to Psomas, Jacobus & Yuang, Inc. has prepared a Conceptual Opinion of Cost for the recommendations presented in each utility section of this report. A copy of the Concept Opinion of Cost will be provided to the CPM as a separate report.

#### 0.6 EXISTING AND PROPOSED BUILDING IMPROVEMENTS

The following table ES-1 identifies the existing buildings on campus and corresponds to the various figures throughout the report. The listed building names and numbers are based upon the Prop. J Master Plan and are illustrated on Figure 0b, Overall Campus Map – Existing Building Layout, included herein. Buildings listed in the color **blue** are currently under construction and are considered existing for the purpose of this report.

Table ES-1: Existing Buildings

Bldg No.	Building Name
1	Administration *
3	Foreign Language
6	Engineering
7	South Gym
8	Life Science
9	Cafeteria *
10	Theater Arts *
11	Music
19	Business & Journalism
46	Ticket Office / Concession Stand
47	Field House *
48	Art

50	Math Science
51	Planetarium
52	Behavioral Science
53	Humanities
54	Motion Picture / TV Studio
55	Life Science Building Storage
56	Campus Center
64	Gymnastic Center *
67	North Gym
68	Library / Academic Resource Center (LARC)
70	Child Development Center *
72	Project Management *
73	Computer Science (CSIT) *
74	Financial Aid *
75	M&O-Sheriff Office
76	Allied Health Science
77	Central Power Plant
78	Drawing / Music *
82	Business Office *
83	Screen Wall Elec. Cabinet Enclosure *
102	Student Services Center
116	Coffee House *
F-11	Learning Center *
F-12	Temporary Library *
H-8	Pool Equipment Building
B 1-2	Bungalows *
B 3-6	Bungalows *
B 7-8	Bungalows *
B 9-10	Bungalows *
B 11	Bungalow *
B 12	Bungalow *
B 13-14	Bungalows *
B 15-16	Historic Museum Bungalows *
B 24-26	Bungalows *
B 30-31	Bungalows *
B 32-34	Bungalows *

B 35-36	Bungalows *
B 37-38	Bungalows *
B 42	Bungalows *
B 45-47	Reading Center Bungalows *
B 48-49	Bungalows *
B 50-52	Bungalows *
B 70-73	Family Resource Center Bungalows *
B 74	Cooperative Education Bungalow *
B 80-85	Bungalows *
V-70	Child Development & family Complex
V-71	Family Resource Center

Figure 0c, Overall Campus Map – Building Demolition Plan, illustrates existing buildings to be demolished as part of the Prop. J Master Plan build-out. Buildings to be demolished are identified with an asterisk (\*) in Table ES-1 above.

Based on the Prop. J Master Plan, the proposed buildings listed in Table ES-2 have been identified as part of the future development under Measure J funding. The building names and numbers correspond to the Prop. J Master Plan and are illustrated on Figure 0d, Overall Campus Map – Future Building Layout. The future condition figures included throughout this report illustrate the configurations and sizes of the future buildings only and do not illustrate the proposed layouts of site features such as parking lots and athletic fields as shown in the Prop. J Master Plan. A copy of the future development layout from the Prop. J Master Plan is shown in Figure 0e, Measure J Master Plan Summary.

Table ES-2: Proposed Buildings

Bldg No.	Building Name
V-11	Media Art Center
V-12	Administration / CWCD
V-13	Athletic Training Facility
V-14	Baseball Field House
V-15	Performance Arts Center
V-16	Multi-Purpose PE / Community Services Center
V-18	Parking Structure
V-22	Student Union
V-51	Planetarium Expansion

0.7 CONSTRUCTION PHASING

Based on the Draft Implementation Schedule provided by the Master Planning Architect, Steinberg Architects and the College Project Manager (CPM), the construction timeline for the proposed buildings is shown in the following table ES-3. A copy of the Draft Implementation Schedule is shown in Figure Of. The following information is considered in each utility specific section of this report.

Table ES-3: Proposed Building Construction Schedule

Bldg No.	Building Name	Construction Dates
V-11	Media Art Center	July 2011 – June 2013
V-12	Administration / CWCD	July 2011 – June 2013
V-13	Athletic Training Facility	Jan. 2011 – June 2012
V-14	Baseball Field House	Jan. 2011 – June 2012
V-15	Performance Arts Center	July 2011 – June 2013
V-16	Multi-Purpose PE / Community Services Center	July 2011 – June 2013
V-18	Parking Structure	July 2013 – Dec. 2014
V-22	Student Union	July 2011 – June 2013
V-51	Planetarium Expansion	Jan. 2014 – Dec. 2014

For the purpose of this report, the future development has been broken into the following three construction phases based on anticipation completion dates provided in Table ES-3, above:

- Phase 1 – Completed in 2012
- Phase 2 – Completed in 2013
- Phase 3 – Completed in 2014

The construction phases are illustrated in Figure 0g, Phasing Diagram. Phase 3 represents final build-out of the Prop. J Master Plan. Table ES-4 represents the proposed buildings to be completed during each phase of construction. Upgrades and modifications to the existing utility systems are considered for each phase of construction.

Table ES-4: Construction Phasing

Phase	Description
Phase 1	Completion of: V-13 – Athletic Training Facility V-14 – Baseball Field House
Phase 2	Completion of: V-11 – Media Art Center V-12 – Administration / CWCD V-15 – Performance Art Center V-16 – Multi-Purpose PE / Community Services Center V-22 – Student Union
Phase 3	Completion of: V-18 – Parking Structure V-51 – Planetarium Expansion

*(Page Intentionally Left Blank)*

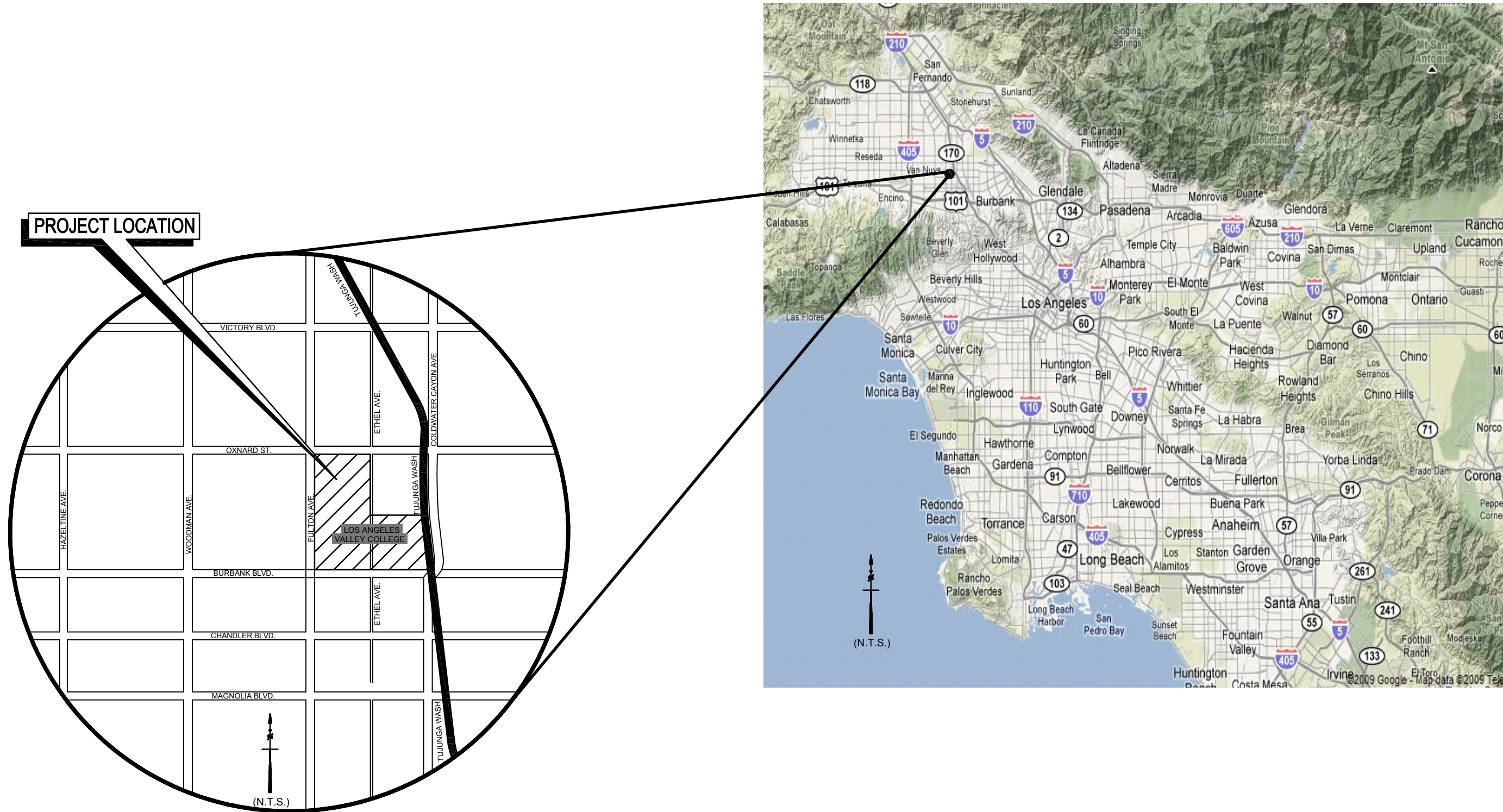
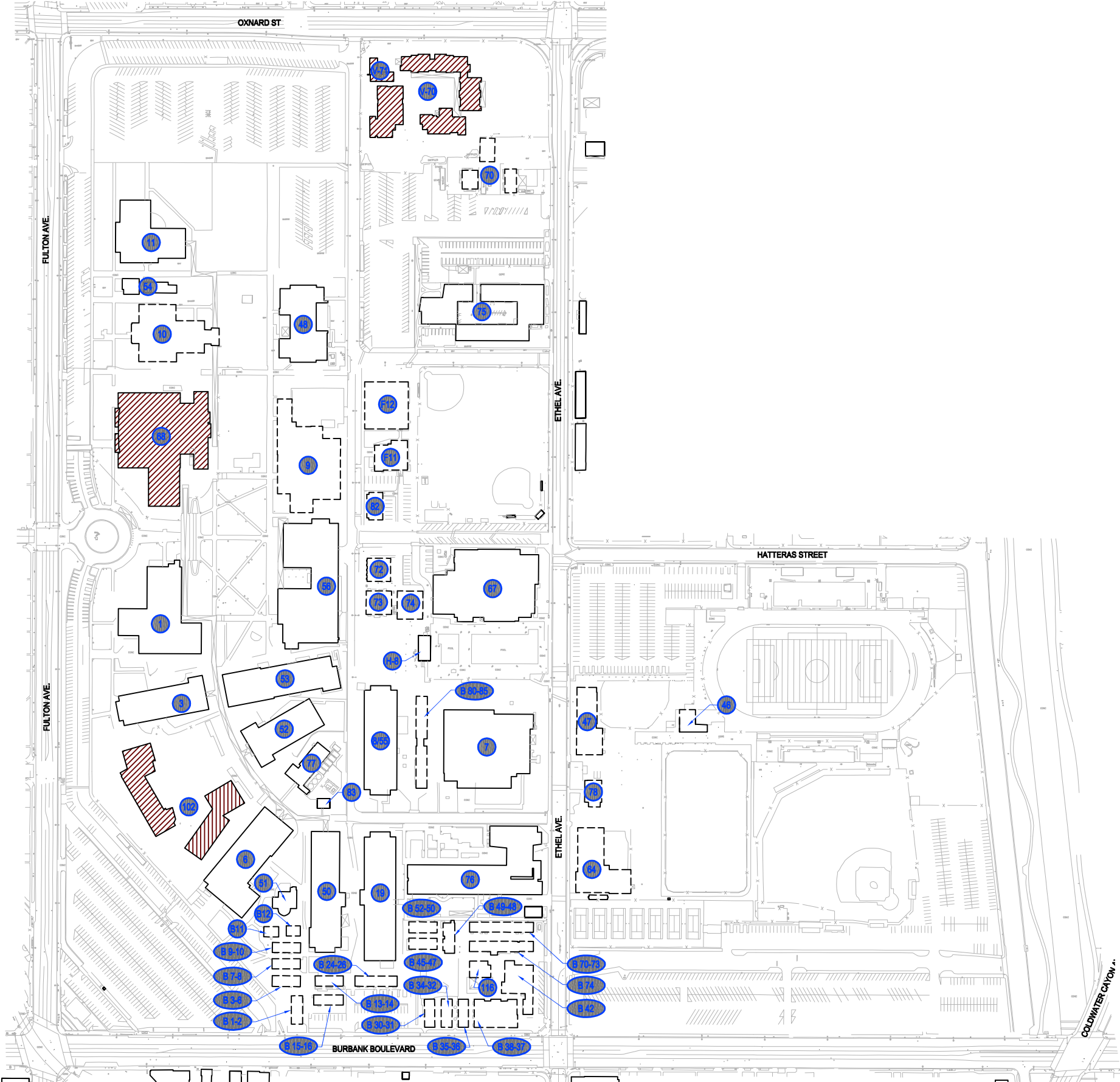


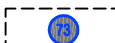



FIGURE 0a  
LOCATION MAP

*(Page Intentionally Left Blank)*



**LEGEND:**

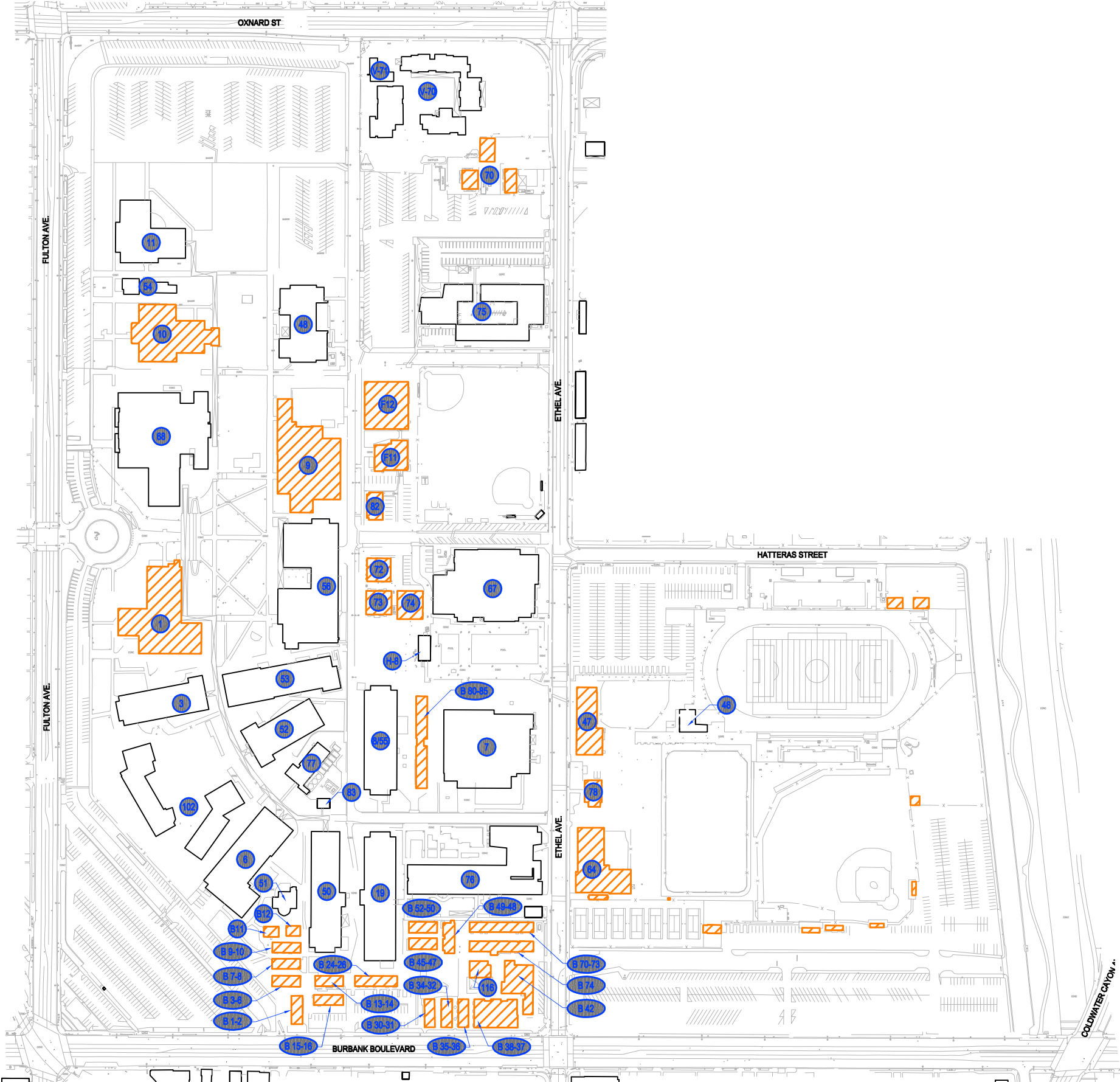
-  EXISTING BUILDING
-  EXISTING BUILDING
-  BUILDING TO BE DEMOLISHED (SEE FIGURE O<sub>c</sub>)
-  BUILDING CURRENTLY UNDER CONSTRUCTION

**NOTE:**  
 1. REFER TO TABLES ES-1 AND ES-2 FOR BUILDING NAMES.



FIGURE 0b  
 OVERALL CAMPUS MAP - EXISTING BUILDING LAYOUT

*(Page Intentionally Left Blank)*



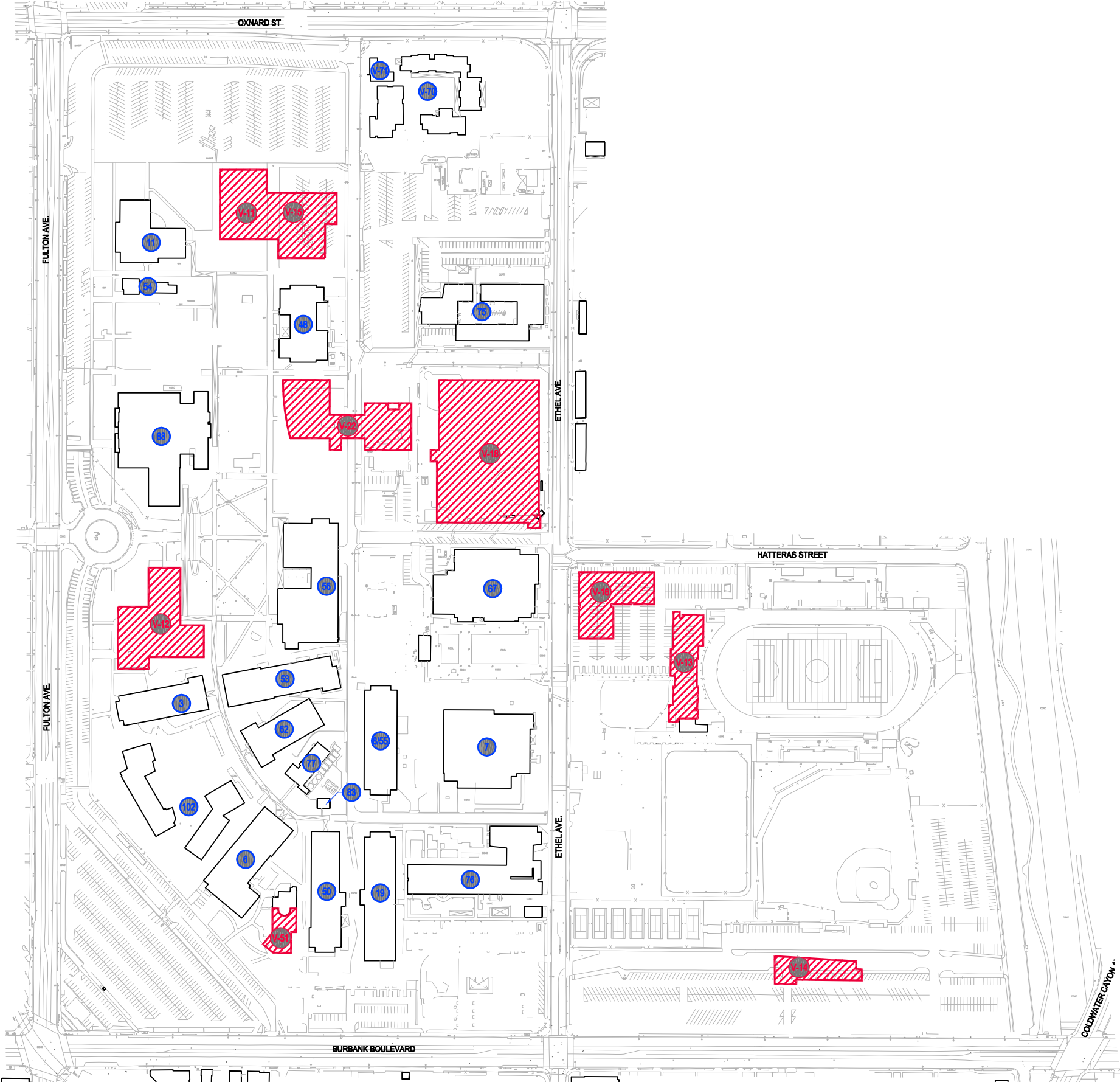
**LEGEND:**  
 EXISTING BUILDING  
 EXISTING BUILDING TO BE DEMOLISHED

**NOTE:**  
 1. REFER TO TABLES ES-1 AND ES-2 FOR BUILDING NAMES.





FIGURE 0c  
 OVERALL CAMPUS MAP - BUILDING DEMOLITION PLAN

*(Page Intentionally Left Blank)*



**LEGEND:**

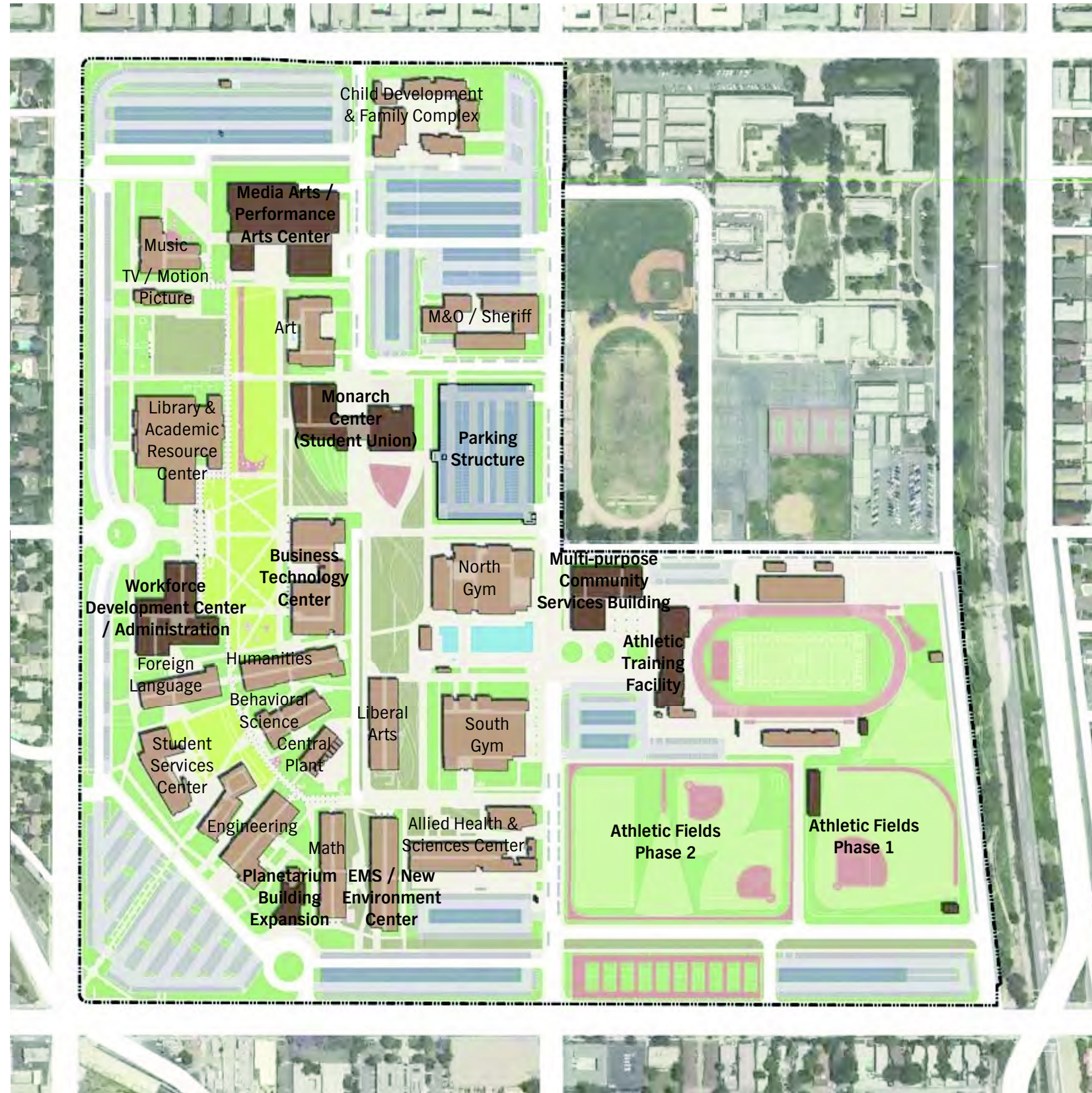
-  EXISTING BUILDING
-  PROPOSED MEASURE J BUILDING

- NOTE:**
1. REFER TO TABLES ES-1 AND ES-2 FOR BUILDING NAMES.
  2. FUTURE CONDITIONS UTILITY MAPS SHOW ONLY THE DISPOSITION OF FUTURE BUILDINGS. REFER TO FIGURE 0e-MEASURE J MASTER PLAN SUMMARY FOR COMPLETE LAYOUT OF FUTURE CONDITIONS.



FIGURE 0d  
 OVERALL CAMPUS MAP - FUTURE BUILDING LAYOUT

*(Page Intentionally Left Blank)*



# Draft Master Plan - Horizon 1

FIGURE 0e  
MEASURE J MASTER PLAN SUMMARY

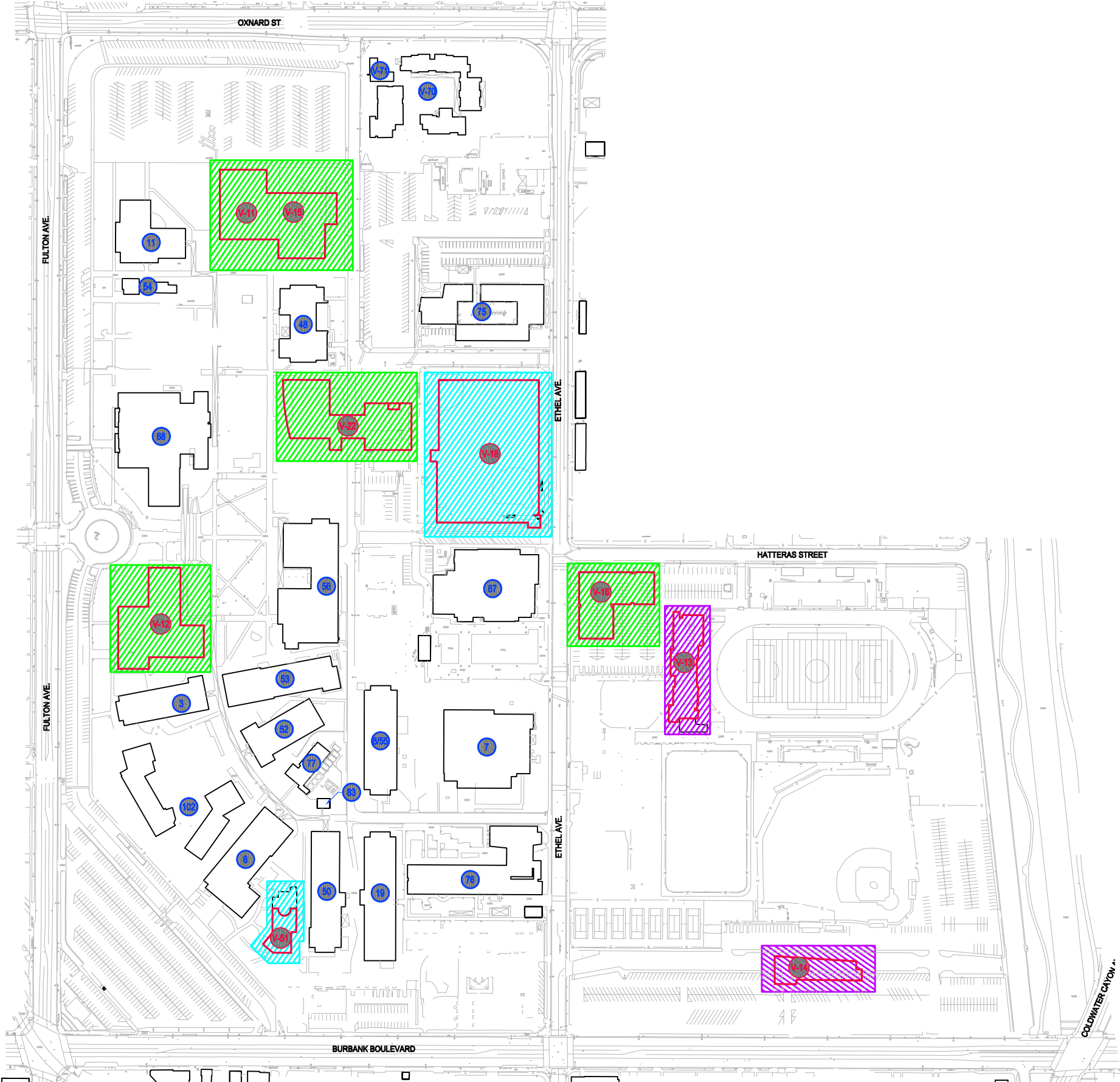
*(Page Intentionally Left Blank)*



# Draft Implementation Schedule

FIGURE OF  
DRAFT IMPLEMENTATION SCHEDULE

*(Page Intentionally Left Blank)*



- LEGEND:**
- PHASE 1  
COMPLETED IN 2012
  - PHASE 2  
COMPLETED IN 2013
  - PHASE 3  
COMPLETED IN 2014

**NOTE:**  
 1. REFER TO TABLES ES-1 AND ES-2 FOR BUILDING NAMES.



FIGURE 0g  
 PHASING DIAGRAM

*(Page Intentionally Left Blank)*

**SECTION 1 – SANITARY SEWER SYSTEM**

**1.1 SYSTEM DESCRIPTION**

The Los Angeles Valley College sanitary sewer system is served by two public sewer mains, an 8-inch main located in Fulton Ave, and a 10-inch main located in Ethel Ave. In general, buildings on the west side of campus adjacent to Fulton Ave. discharge west to the 8-inch sanitary sewer pipe in Fulton Ave. The remainder of the campus discharges to the 10-inch sanitary sewer pipe in Ethel Ave. Although Ethel Ave. is a part of the campus, the underlying public utilities are owned and operated by the City of Los Angeles and both public sewer mains receive sewage effluent from residential neighborhoods surrounding the campus. The City of Los Angeles public sewer mains are identified in Figure 1a, Existing Utility map – Sanitary Sewer. This study shall be limited to the analysis of on-site campus sanitary sewer system.

**1.2 METHODOLOGY**

The on-site sanitary sewer system was mapped per existing utility documentation provided by the College Project Manager (CPM) including available archived utility maps and record data from building and site development projects. Where possible, the horizontal location of the existing on-site sanitary sewer lines were verified per surveyed surface indications. Similarly, the vertical location of the sanitary sewer was verified at existing manholes. Vertical data was also obtained from pothole information of critical sanitary sewer lines without manholes. A copy of the sanitary sewer pothole report can be found in Appendix E of this report.

The average daily flow rates produced by the on-site buildings were calculated per the City of Los Angeles’ Bureau of Engineering Sewer Design Manual. Average daily flows from all the buildings were calculated on an occupancy type basis per Table F229 of the City of Los Angeles’ Bureau of Engineering Sewer Design Manual.

Per City of LA Sewer Manual Section F200, a peaking factor of 3.5 was applied to determine the peak flow rates. This study shall compare the calculated peak flow rates to the downstream pipe’s capacity to determine whether the downstream pipe has adequate capacity.

**1.3 ANALYSIS OF EXISTING SYSTEM**

Table 1-1 summarizes the existing campus buildings’ square footage, occupancy type, and flow allocation used to determine the average daily flow generated on campus. The existing system analysis includes the existing campus buildings listed in Table ES-1 of the Executive Summary.

Based upon the City of LA criteria, the existing average daily flow rate generated from on campus buildings is calculated at 226,054 gallons per day (gpd), which is equivalent to an average flow rate of 0.350 cubic feet per second (cfs).

The capacity of the existing system was calculated based on the material type, slope, and size of the existing sewer pipes. A sanitary sewer capacity analysis was performed for each connection to the City of Los Angeles sanitary sewer system. Each of the 14 sanitary sewer connections correspond to an Area “A” through “P”; the letters “I” and “O” were omitted due to their resemblance to numerical values. A key map illustrating the sewer area locations is provided as Figure 1c, Existing Sanitary Sewer Pipe and Node Key Map.

Per the City of Los Angeles sanitary sewer design guidelines, the maximum allowable flow is one-half the full flow capacity of the pipe. Table 1-2 includes the input (size, material, and slope) and output (allowable and peak flow rate) data from the existing sanitary sewer system model. Using Manning’s equation, the capacity of the each pipe is calculated.

The invert information labeled with an N/A denotes that the invert information is not available and was not provided in the surface indications survey. Where the slope of the pipe could not be verified by survey data, slopes meeting the minimum design guideline requirements were assumed. For existing pipes where the material was unknown, Vitrified Clay Pipe (VCP) was assumed. Sewer analysis Figure 1d-1p, Existing Sanitary Sewer – Pipe and Node Maps correspond to the existing system model provided in Table 1-2.

**1.4 ANALYSIS OF FUTURE NEEDS**

The sanitary sewer system was evaluated with the addition of the proposed buildings listed in Table ES-2 of the Executive Summary. Based on the future development presented in the Prop. J Master Plan, and as discussed in the Executive Summary, recommendations have been made to relocate, demolish and replace various existing sanitary sewer pipe lines in order to accommodate the future development. This is conceptually illustrated in Figure 1b, Future Conditions Utility Map – Sanitary Sewer. The proposed sanitary sewer alignments are the basis for the proposed system evaluation and analysis presented herein.

Table 1-3 summarizes the proposed campus buildings’ square footage (based on the Prop. J Master Plan), occupancy type, and flow allocation used to determine the average day flow expected to be generated on campus. Based upon the City of LA criteria, the future average day flow generated on campus is estimated at 213,388 gpd, which is equivalent to an average flow rate of 0.330 cfs.

Table 1-4 includes the input and output data from the proposed sanitary sewer system model and using Manning’s equation, provides a calculated flow capacity for the proposed sanitary sewer system. Based on City of Los Angeles design criteria, the sanitary sewer pipe is considered at capacity when half-full. The average daily flow is derived from the proposed building allocation information presented in Table 1-3. The invert information labeled with an N/A denotes that the invert information is not available and was not provided in the surface indications survey. Pipes segment and node information shown in the color **red** denotes new sanitary sewer pipelines to be constructed to replace existing pipes or accommodate the future development. All new pipes were assumed to be PVC and have a minimum slope of 0.5%.

Further description is provided in the Findings and Recommendations Section. Figure 1n-1r, Proposed Sanitary Sewer – Pipe and Node Maps correspond to the proposed system model provided in Table 1-4.

**1.5 FINDINGS AND RECOMMENDATIONS**

Findings

The anticipated sewage flow rates from the existing buildings are all well within the capacity of the campus’ sewer system. However, flow velocities for many of the existing sewers are below the 3 ft/s minimum velocity recommended by the City of Los Angeles. It is impractical to correct this deficiency as it would require reconstruction of the sewer system. However, the negative effects can be partially mitigated by flushing the sewers on a routine basis.

Table 1-5, below, provides a summary of the total sanitary sewer flow entering the City of Los Angeles sewer mains in Fulton Ave., Ethel Ave., and Burbank Ave at both existing and proposed conditions.

Table 1-5: Sanitary Sewer Flow Summary

	Average Daily Flow (gpd)	Average Daily Flow (cfs)
<b>Fulton Ave.</b>		
Existing Campus Generated Sewer Flows	53,641	0.083
Proposed Campus Generated Sewer Flows	52,377	0.081
<b>Net Increase</b>	-1,264	-0.002
<b>Ethel Ave.</b>		
Existing Campus Generated Sewer Flows	172,413	0.267
Proposed Campus Generated Sewer Flows	160,761	0.249
<b>Net Increase</b>	-11,652	-0.028
<b>Burbank Blvd.</b>		
Existing Campus Generated Sewer Flows	0	0
Proposed Campus Generated Sewer Flows	250	0
<b>Net Increase</b>	250	0
<b>Total Campus Flow</b>		
Existing Campus Generated Sewer Flows	226,054	0.350
Proposed Campus Generated Sewer Flows	206,714	0.330
<b>Total Increase</b>	-19,340	-0.020

Tables 1-2 through 1-4 provide a summary of the sanitary sewer system maximum flow rate (or capacity); average daily flow rate, and peak flow rate for both existing and proposed sanitary sewer systems at each pipe segment.

Recommendations

The recommendations presented herein include extension of the sanitary sewer system to serve proposed buildings presented in the Prop. J Master Plan; and removal and relocation of existing sanitary sewer service mains and laterals serving existing buildings planned to be demolished to provide a clear site for future development. The recommendations have been categorized into three priority levels. Descriptions of each priority level are provided in the executive summary of this report.

As illustrated in Figure 1b, Future Conditions Utility Map – Sanitary Sewer, the following are recommendations for improvements to the existing sanitary sewer system:

Priority 1

- Construct a new 8-inch sanitary sewer pipe extension from Area K sanitary sewer system to serve the future Media Arts Center (Building V-11) and Performing Arts Center (Building V-15).
- Relocate the existing 8-inch sanitary sewer pipe from Area K serving Building 48 prior to the construction of the Student Union (Building V-22).
- Construct a new 6-inch sanitary sewer pipe to serve the future Administration/CWCD (Building V-12) in Area A.
- Construct a new 4-inch sanitary sewer lateral to serve the future Planetarium Expansion (Building V-51) in Area A.
- Before the construction of the Planetarium Expansion Building (Building V-51), divert the discharge from the Math and Science Building (Building 50) from Area A to the western reach of Area C by constructing a new 4-inch sanitary sewer pipe.
- Before the construction of Buildings V-13 and V-16, relocate the 6-inch Area J sanitary sewer pipe and City of LA point of connection in Ethel Ave. to serve the future Athletic Training Facility (Building V-13) and the Multi-purpose PE/Community Services Center (Building V-16), and the Home Spectator Area.
- Remove the interfering portion of the existing 6-inch sanitary sewer line serving the Visitor's Bleachers in Area P; and provide a connection to serve the future Baseball Field House (Building V-14).
- Where Buildings and Facilities are demolished, and the City of Los Angeles Sanitary Sewer connection is no longer needed, cap the sanitary sewer pipes inside the property line.

Priority 2

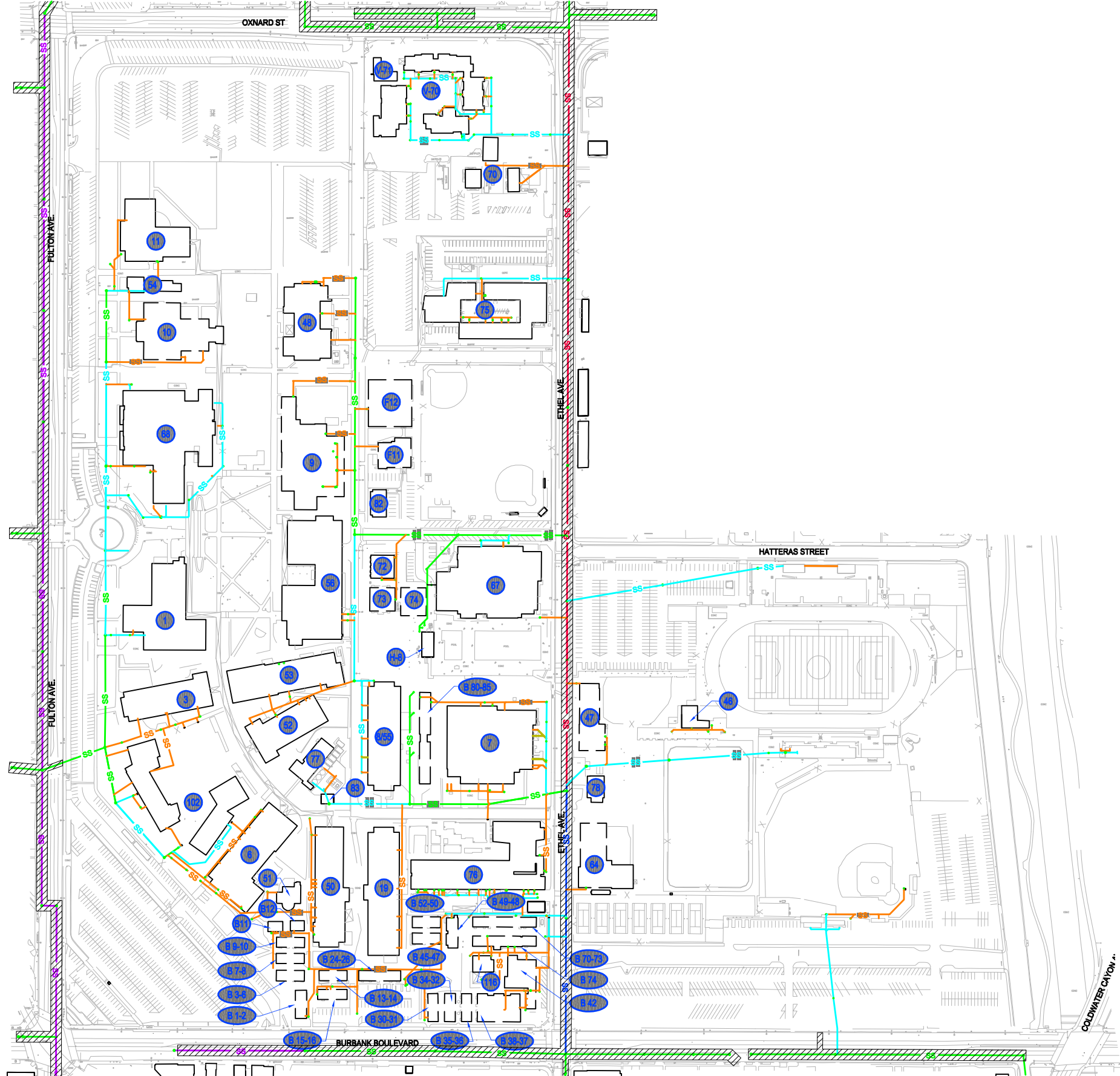
- In order to provide a clear site for future development:
  - Remove or abandon the existing sanitary sewer laterals currently serving the bungalows to be demolished at the northwest corner of Ethel Ave. and Burbank Blvd.,
  - Remove the laterals serving buildings 9, 48, 70, 72, 73, 74, 82, and F-12, which are also planned to be demolished.










Based upon the discussions with the campus facilities department, the following are recommendations for improving the existing sanitary sewer:

Priority 2

- The 6" lateral serving Building 56 at the northeast end has been reported as having clogging issues, possibly due to a nearby tree. The 6" lateral should be repaired and/or cleaned from root intrusion damage.

The findings and recommendations presented in this report are determined from City of Los Angeles sanitary sewer design criteria and standard planning guidelines. In the case that the individual proposed building designs yield larger flow rates than presented herein, it is recommended that the college re-evaluate the data analysis and update the findings.









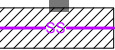
- LEGEND:**
-  EXISTING BUILDING
  -  18" EXISTING SANITARY SEWER LINE
  -  12" EXISTING SANITARY SEWER LINE
  -  10" EXISTING SANITARY SEWER LINE
  -  8" EXISTING SANITARY SEWER LINE
  -  6" EXISTING SANITARY SEWER LINE
  -  5" EXISTING SANITARY SEWER LINE
  -  4" OR SMALLER EXISTING SANITARY SEWER LINE
  -  CITY OF LA SANITARY SEWER

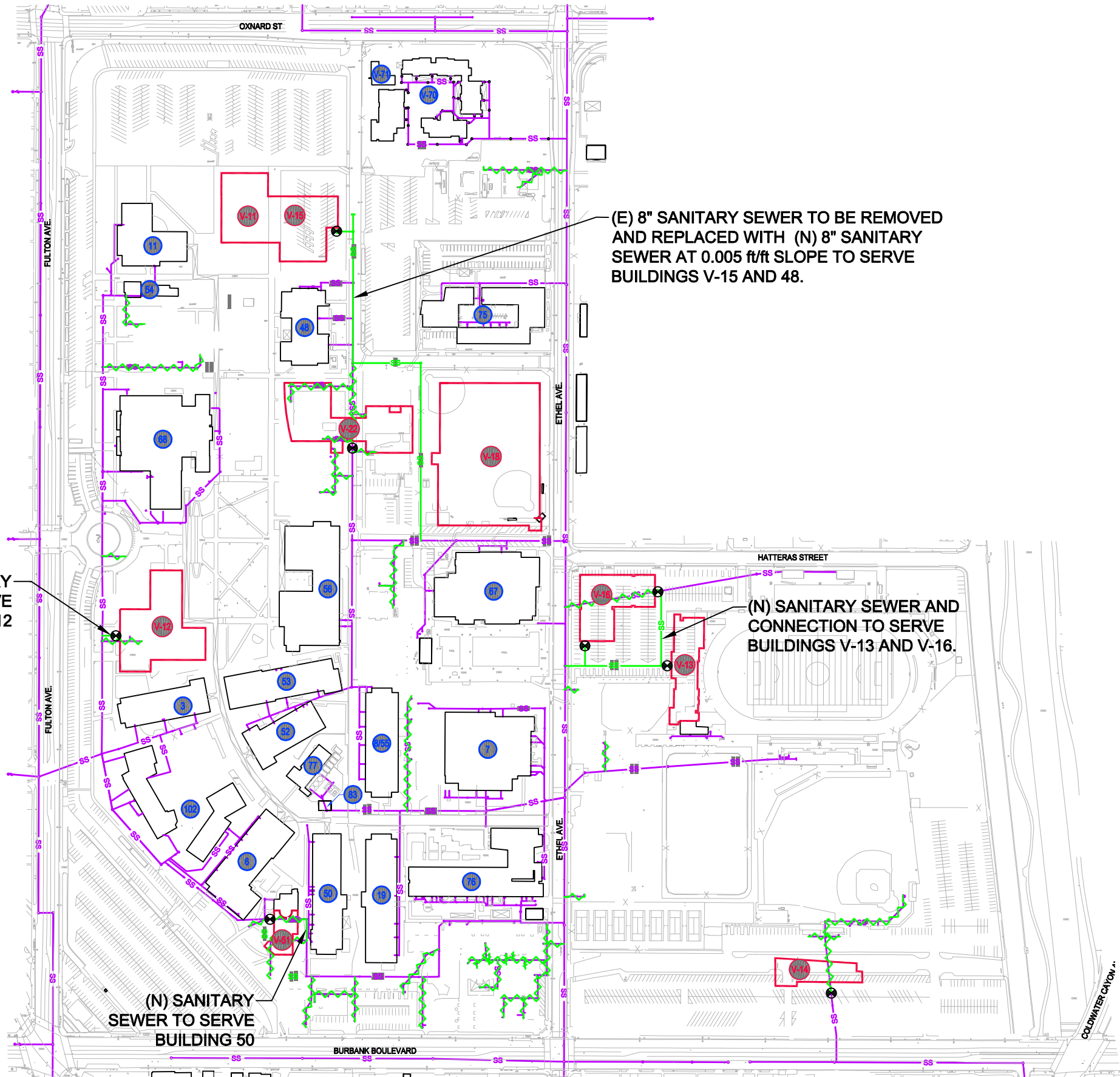
- NOTE:**
1. REFER TO TABLES ES-1 AND ES-2 FOR BUILDING NAMES.
  2. THE INFORMATION SHOWN HEREON IS A GRAPHICAL DEPICTION OF THE EXISTING CAMPUS UTILITY SYSTEMS. THE SITE SURVEY AND INFRASTRUCTURE STUDIES EXISTING UTILITY PLANS PREPARED UNDER SEPARATE COVER SHALL BE REFERENCED FOR DETAILED INFORMATION

FIGURE 1a  
 EXISTING UTILITY MAP - SANITARY SEWER

*(Page Intentionally Left Blank)*

**LEGEND:**

-  EXISTING BUILDING
-  EXISTING SANITARY SEWER LINE
-  PROPOSED BUILDING
-  PROPOSED P.O.C. FOR FUTURE BUILDING
-  EXISTING SANITARY SEWER LINE TO BE REMOVED
-  PROPOSED SANITARY SEWER LINE
-  CITY OF LA EASEMENT



(N) 6" PVC SANITARY SEWER TO SERVE BUILDING V-12

(E) 8" SANITARY SEWER TO BE REMOVED AND REPLACED WITH (N) 8" SANITARY SEWER AT 0.005 ft/ft SLOPE TO SERVE BUILDINGS V-15 AND 48.

(N) SANITARY SEWER AND CONNECTION TO SERVE BUILDINGS V-13 AND V-16.

(N) SANITARY SEWER TO SERVE BUILDING 50

- NOTE:**
1. REFER TO TABLES ES-1 AND ES-2 FOR BUILDING NAMES.
  2. THE INFORMATION SHOWN HEREON IS A GRAPHICAL DEPICTION OF THE EXISTING CAMPUS UTILITY SYSTEMS. THE SITE SURVEY AND INFRASTRUCTURE STUDIES EXISTING UTILITY PLANS PREPARED UNDER SEPARATE COVER SHALL BE REFERENCED FOR DETAILED INFORMATION
  3. FUTURE CONDITIONS UTILITY MAPS SHOW ONLY THE DISPOSITION OF FUTURE BUILDINGS. REFER TO FIGURE 0e-MEASURE J MASTER PLAN SUMMARY FOR COMPLETE LAYOUT OF FUTURE CONDITIONS.



FIGURE 1b  
 FUTURE CONDITIONS UTILITY MAP - SANITARY SEWER

*(Page Intentionally Left Blank)*

Table 1-1: Existing Campus Sanitary Sewer Flow Allocation

Bldg No.	Building Name	Area (GSF)	Land Use (LU) Classification	Average Daily Flow (ADF) Rate (gpd/unit)	Average Daily Flow (ADF) Unit	Q Average Daily Flow (ADF) Rate (gpd)	Q Average Daily Flow (ADF) Rate (cfs)
1	ADMINISTRATION	26,955	Office	200	1000 GSF	5,391	0.008
3	FOREIGN LANGUAGE	16,130	Schl: Vocational	343	1000 GSF	5,531	0.009
6	ENGINEERING	24,145	Schl: Vocational	343	1000 GSF	8,280	0.013
7	SOUTH GYM	45,200	Gymnasium	300	1000 GSF	13,560	0.021
8	LIFE SCIENCE	20,660	Schl: Vocational	343	1000 GSF	7,086	0.011
9	CAFETERIA	29,345	Cafeteria	50	Seat	17,000	0.026
10	THEATER ARTS	21,693	Schl: Vocational	343	1000 GSF	7,439	0.012
11	MUSIC	16,441	Schl: Vocational	343	1000 GSF	5,638	0.009
19	BUSINESS & JOURNALISM	22,590	Schl: Vocational	343	1000 GSF	7,747	0.012
46	TICKET OFFICE / CONCESSION STAND RENOVATION	2,936	Retail	100	1000 GSF	294	0.000
47	FIELD HOUSE	9,764	Warehouse	25	1000 GSF	244	0.000
48	ART	18,965	Schl: Vocational	343	1000 GSF	6,504	0.010
50	MATH SCIENCE	19,611	Schl: Vocational	343	1000 GSF	6,725	0.010
51	PLANETARIUM	2,616	Schl: Vocational	343	1000 GSF	897	0.001
52	BEHAVIORAL SCIENCE	13,700	Schl: Vocational	343	1000 GSF	4,698	0.007
53	HUMANITIES	19,400	Schl: Vocational	343	1000 GSF	6,653	0.010
54	MOTION PICTURES / TV STUDIO	4,700	Studio/Motion Picture	5	7 GSF	3,357	0.005
55	LIFE SCIENCE BUILDING STORAGE	198	Warehouse	25	1000 GSF	5	0.000
56	CAMPUS CENTER	83,553	Retail	100	1000 GSF	8,355	0.013
64	GYMNASTIC CENTER	18,700	Gymnasium	300	1000 GSF	5,610	0.009
67	NORTH GYM	37,963	Gymnasium	300	1000 GSF	11,389	0.018
68	LIBRARY / ACADEMIC RESOURCE CENTER (LARC)	92,922	Library	25	1000 GSF	2,323	0.004
70	CHILD DEVELOPMENT CENTER	5,830	Day Care Center	10	Child	1,140	0.002
72	PROJECT MANAGER	3,592	Office Bungalow	200	1000 GSF	718	0.001
73	COMPUTER SCIENCE (CSIT)	3,600	Schl: Vocational	343	1000 GSF	1,235	0.002
74	FINANCIAL AID	4,320	Office	200	1000 GSF	864	0.001
75	M&O-SHERIFF OFFICE	26,452	Office	200	1000 GSF	5,290	0.008
76	ALLIED HEALTH SCIENCE	80,767	Schl: Vocational	343	1000 GSF	27,697	0.043
77	CENTRAL POWER PLANT	5,694	MNFG/Industry	100	1000 GSF	569	0.001
78	DRAWING/MUSIC	2,807	Schl: Vocational	343	1000 GSF	963	0.001
82	BUSINESS OFFICE	2,709	Schl: Vocational	343	1000 GSF	929	0.001
83	SCREEN WALL ELEC CABINET ENCLOSURE	151	-	-	-	0	0.000

Table 1-1: Existing Campus Sanitary Sewer Flow Allocation (Continued)

Bldg No.	Building Name	Area (GSF)	Land Use (LU) Classification	Average Daily Flow (ADF) Rate (gpd/unit)	Average Daily Flow (ADF) Unit	Q Average Daily Flow (ADF) Rate (gpd)	Q Average Daily Flow (ADF) Rate (cfs)
102	STUDENT SERVICES CENTER	40,186	Office	200	1000 GSF	8,037	0.012
116	COFFEE HOUSE	787	Retail	100	1000 GSF	79	0.000
F-11	LEARNING CENTER	13,532	Library	50	50 GSF	13,532	0.021
F-12	TEMP LIBRARY	6001	Library	50	50 GSF	6,001	0.009
H-8	POOL EQUIPMENT BUILDING	1,992	Industrial	412	GPM peak	412	0.001
B 1-2	BUNGALOWS	2,087	Schl: Vocational	343	1000 GSF	716	0.001
B 3-6	BUNGALOWS	2,014	Schl: Vocational	343	1000 GSF	691	0.001
B 7-8	BUNGALOWS	1,906	Schl: Vocational	343	1000 GSF	654	0.001
B 9-10	BUNGALOWS	1,873	Schl: Vocational	343	1000 GSF	642	0.001
B 11	BUNGALOW	999	Schl: Vocational	343	1000 GSF	343	0.001
B 12	BUNGALOW	937	Schl: Vocational	343	1000 GSF	321	0.000
B 13-14	BUNGALOWS	1,900	Schl: Vocational	343	1000 GSF	652	0.001
B 15-16	HISTORICAL MUSEUM / BUNGALOWS	1,979	Schl: Vocational	343	1000 GSF	679	0.001
B 24-26	BUNGALOWS	2,866	Schl: Vocational	343	1000 GSF	983	0.002
B 30-31	BUNGALOWS	1,888	Schl: Vocational	343	1000 GSF	647	0.001
B 32-34	BUNGALOWS	2,047	Schl: Vocational	343	1000 GSF	702	0.001
B 35-36	BUNGALOWS	1,866	Schl: Vocational	343	1000 GSF	640	0.001
B 37-38	BUNGALOWS	7,855	Schl: Vocational	343	1000 GSF	2,694	0.004
B 42	BUNGALOWS	7,124	Schl: Vocational	343	1000 GSF	2,443	0.004
B 45-47	READING CENTER BUNGALOWS	2,055	Schl: Vocational	343	1000 GSF	705	0.001
B 48-49	BUNGALOWS	2,347	Schl: Vocational	343	1000 GSF	805	0.001
B 50-52	BUNGALOWS	2,072	Schl: Vocational	343	1000 GSF	711	0.001
B 70 -73	FAMILY RESOURCE CENTER / BUNGALOWS	4,199	Schl: Vocational	343	1000 GSF	1,440	0.002
B 74	COOPERATIVE EDUCATION BUNGALOW	4,334	Schl: Vocational	343	1000 GSF	1,486	0.002
B 80-85	BUNGALOWS	6,464	Schl: Vocational	343	1000 GSF	2,217	0.003
V-70	CHILD DEVELOPMENT & FAMILY COMPLEX	19,771	Schl: Vocational	10	Child	1,920	0.003
V-71	FAMILY RESOURCE CENTER	8,869	Office	200	1000 GSF	1,774	0.003
<b>TOTAL</b>		<b>831,869 GSF</b>				<b>226,054 gpd</b>	<b>0.350 cfs</b>

Table 1-2: Existing Sanitary Sewer Model Data

**Area A**

Pipe ID	Upstream Node	Upstream Invert	Downstream Node	Downstream Invert	Length (ft)	Slope (ft/ft)	Pipe Diameter (in.)	Q Capacity (cfs) (D/d = 0.5)	Q Average Daily (cfs)	Q Peak Daily (ADFx3.5)	Tributary Areas (Contributing to Upstream Node)
SS-101	A-101	664.63	A-100	N/A	172	0.01	8	0.60	0.083	0.29	Bldg 68, Bldg 54, Bldg 10, Bldg 3, Bldg 50, Bldg 51, Bldg 6, Bldg 102
SS-200	A-200	665.43	A-101	665.17	25	0.01	8	0.62	0.035	0.12	Bldg 102, Bldg 6, Bldg 51, Bldg 50
SS-201	A-201	666.57	A-200	665.43	100	0.011	8	0.65	0.035	0.12	Bldg 102, Bldg 6, Bldg 51, Bldg 50
SS-202	A-202	666.81	A-201	666.57	20	0.012	8	0.66	0.032	0.11	Bldg 102, Bldg 6, Bldg 51, Bldg 50
SS-203	A-203	668.65	A-202	666.75	190	0.01	8	0.59	0.030	0.10	Bldg 102, Bldg 6, Bldg 51, Bldg 50
SS-204	A-204	N/A	A-203	N/A	10	0.01	6	0.28	0.030	0.10	Bldg 102, Bldg 6, Bldg 51, Bldg 50
SS-205	A-205	N/A	A-204	N/A	10	0.01	6	0.28	0.018	0.06	Bldg 102, Bldg 6
SS-206	A-206	N/A	A-205	N/A	5	0.01	6	0.28	0.005	0.02	Bldg 102
SS-207	A-207	N/A	A-206	N/A	30	0.01	6	0.28	0.002	0.01	Bldg 102
SS-300	A-300	N/A	A-101	N/A	100	0.01	4	0.10	0.011	0.04	Bldg 3, Bldg 102
SS-301	A-301	N/A	A-300	N/A	80	0.01	4	0.10	0.008	0.03	Bldg 3, Bldg 102
SS-302	A-302	N/A	A-301	N/A	80	0.01	4	0.10	0.003	0.01	Bldg 3
SS-400	A-400	667.64	A-101	664.74	290	0.01	8	0.60	0.037	0.13	Bldg 68, Bldg 54, Bldg 10, Bldg 11, Bldg 1
SS-401	A-401	669.29	A-400	667.65	220	0.007	8	0.52	0.029	0.10	Bldg 68, Bldg 54, Bldg 10, Bldg 11
SS-402	A-402	671.15	A-401	669.37	140	0.013	6	0.32	0.029	0.10	Bldg 68, Bldg 54, Bldg 10, Bldg 11
SS-403	A-403	672.09	A-402	671.15	75	0.013	6	0.31	0.029	0.10	Bldg 68, Bldg 54, Bldg 10, Bldg 11
SS-404	A-404	674.39	A-403	672.28	210	0.01	8	0.61	0.025	0.09	Bldg 54, Bldg 10, Bldg 11
SS-405	A-405	674.97	A-404	674.39	60	0.01	8	0.59	0.025	0.09	Bldg 54, Bldg 10, Bldg 11
SS-406	A-406	676.89	A-405	674.98	185	0.01	8	0.61	0.020	0.07	Bldg 54, Bldg 10(p), Bldg 11
SS-407	A-407	N/A	A-406	N/A	16	0.005	8	0.43	0.020	0.07	Bldg 54, Bldg 10(p), Bldg 11
SS-408	A-408	N/A	A-407	N/A	40	0.005	8	0.43	0.015	0.05	Bldg 54, Bldg 10(p), Bldg 11

Table 1-2: Existing Sanitary Sewer Model Data (Continued)

**Area B**

Pipe ID	Upstream Node	Upstream Invert	Downstream Node	Downstream Invert	Length (ft)	Slope (ft/ft)	Pipe Diameter (in.)	Q Capacity (cfs) (D/d = 0.5)	Q Average Daily (cfs)	Q Peak Daily (ADFx3.5)	Tributary Areas (Contributing to Upstream Node)
SS-101	B-101	N/A	B-100	N/A	45	0.01	6	0.28	0.021	0.07	Bldg 38-37, Bldg 42, Bldg 116, Bldg 74
SS-200	B-200	N/A	B-101	N/A	50	0.01	6	0.28	0.021	0.07	Bldg 38-37, Bldg 42, Bldg 116, Bldg 74
SS-300	B-300	N/A	B-101	N/A	40	0.01	4	0.10	0.021	0.07	Bldg 38-37, Bldg 42, Bldg 116, Bldg 74
SS-301	B-301	N/A	B-300	N/A	40	0.01	4	0.10	0.021	0.07	Bldg 38-37, Bldg 42
SS-302	B-302	N/A	B-301	N/A	20	0.01	4	0.10	0.010	0.04	Bldg 38-37, Bldg 42
SS-303	B-303	N/A	B-302	N/A	60	0.01	4	0.10	0.010	0.04	Bldg 38-37, Bldg 42
SS-310	B-310	N/A	B-300	N/A	55	0.01	4	0.10	0.010	0.04	Bldg 116, Bldg 74
SS-311	B-311	N/A	B-310	N/A	30	0.01	4	0.10	0.010	0.04	Bldg 116, Bldg 74
SS-312	B-312	N/A	B-311	N/A	15	0.01	4	0.10	0.010	0.04	Bldg 116, Bldg 74
SS-313	B-313	N/A	B-312	N/A	20	0.01	4	0.10	0.010	0.04	Bldg 116, Bldg 74

**Area C**

Pipe ID	Upstream Node	Upstream Invert	Downstream Node	Downstream Invert	Length (ft)	Slope (ft/ft)	Pipe Diameter (in.)	Q Capacity (cfs) (D/d = 0.5)	Q Average Daily (cfs)	Q Peak Daily (ADFx3.5)	Tributary Areas (Contributing to Upstream Node)
SS-101	C-101	N/A	C-100	N/A	120	0.01	6	0.28	0.043	0.15	Bldg B 11, Bldg B 12, Bldg B 9-10, Bldg B-7-8, Bldg B 3-6, Bldg B 1-2, Bldg B 15-16, Bldg B 13-14, Bldg B 30-31, Bldg B 24-26, Bldg B 45-47, Bldg B 50-52, Bldg 76
SS-102	C-102	N/A	C-101	N/A	200	0.01	6	0.28	0.012	0.04	Bldg B 11, Bldg B 12, Bldg B 9-10, Bldg B-7-8, Bldg B 3-6, Bldg B 1-2, Bldg B 15-16, Bldg B 13-14, Bldg B 30-31, Bldg B 24-26, Bldg B 45-47, Bldg B 50-52
SS-103	C-103	N/A	C-102	N/A	65	0.01	4	0.10	0.011	0.04	Bldg B 11, Bldg B 12, Bldg B 9-10, Bldg B-7-8, Bldg B 3-6, Bldg B 1-2, Bldg B 15-16, Bldg B 13-14, Bldg B 30-31, Bldg B 24-26, Bldg B 45-47
SS-104	C-104	N/A	C-103	N/A	70	0.01	4	0.10	0.008	0.03	Bldg B 11, Bldg B 12, Bldg B 9-10, Bldg B-7-8, Bldg B 3-6, Bldg B 1-2, Bldg B 15-16, Bldg B 13-14, Bldg B 30-31
SS-105	C-105	N/A	C-104	N/A	40	0.01	4	0.10	0.008	0.03	Bldg B 11, Bldg B 12, Bldg B 9-10, Bldg B-7-8, Bldg B 3-6, Bldg B 1-2, Bldg B 15-16, Bldg B 13-14, B-30-31
SS-106	C-106	N/A	C-105	N/A	175	0.01	4	0.10	0.007	0.03	Bldg B 11, Bldg B 12, Bldg B 9-10, Bldg B-7-8, Bldg B 3-6, Bldg B 1-2, Bldg B 15-16, Bldg B 13-14
SS-107	C-107	N/A	C-106	N/A	110	0.01	4	0.10	0.005	0.02	Bldg B 11, Bldg B 12, Bldg B 9-10, Bldg B-7-8, Bldg B 3-6, Bldg B 1-2
SS-108	C-108	N/A	C-107	N/A	15	0.01	4	0.10	0.004	0.01	Bldg B 11, Bldg B 12, Bldg B 9-10, Bldg B-7-8, Bldg B 3-6
SS-109	C-109	N/A	C-108	N/A	90	0.01	4	0.10	0.004	0.01	Bldg B 11, Bldg B 12, Bldg B 9-10, Bldg B-7-8, Bldg B 3-6
SS-200	C-200	N/A	C-101	N/A	45	0.01	6	0.28	0.031	0.11	Bldg 76

Table 1-2: Existing Sanitary Sewer Model Data (Continued)

**Area D**

Pipe ID	Upstream Node	Upstream Invert	Downstream Node	Downstream Invert	Length (ft)	Slope (ft/ft)	Pipe Diameter (in.)	Q Capacity (cfs) (D/d = 0.5)	Q Average Daily (cfs)	Q Peak Daily (ADF <sub>x3.5</sub> )	Tributary Areas (Contributing to Upstream Node)
SS-101	D-101	N/A	D-100	N/A	50	0.01	4	0.10	0.009	0.03	Bldg 64

**Area E**

Pipe ID	Upstream Node	Upstream Invert	Downstream Node	Downstream Invert	Length (ft)	Slope (ft/ft)	Pipe Diameter (in.)	Q Capacity (cfs) (D/d = 0.5)	Q Average Daily (cfs)	Q Peak Daily (ADF <sub>x3.5</sub> )	Tributary Areas (Contributing to Upstream Node)
SS-101	E-101	N/A	E-100	658.06	50	0.005	8	0.43	0.049	0.17	Bldg B80-85, Bldg 7, Bldg 83, Bldg 19, Bldg 76,
SS-200	E-200	N/A	E-101	N/A	65	0.01	6	0.28	0.016	0.06	Bldg B80-85, Bldg 7
SS-201	E-201	N/A	E-200	N/A	15	0.01	6	0.28	0.013	0.05	Bldg B80-85, Bldg 7
SS-202	E-202	N/A	E-201	N/A	60	0.01	6	0.28	0.011	0.04	Bldg B80-85, Bldg 7
SS-203	E-203	N/A	E-202	N/A	90	0.01	6	0.28	0.008	0.03	Bldg B80-85, Bldg 7
SS-204	E-204	N/A	E-203	N/A	105	0.01	4	0.10	0.007	0.02	Bldg B80-85, Bldg 7
SS-205	E-205	N/A	E-204	N/A	30	0.01	4	0.10	0.005	0.02	Bldg B80-85, Bldg 7
SS-206	E-206	N/A	E-205	N/A	30	0.01	4	0.10	0.003	0.01	Bldg B80-85, Bldg 7
SS-300	E-300	N/A	E-101	N/A	150	0.005	8	0.43	0.021	0.07	Bldg 83*, Bldg 77*, Bldg 19, Bldg 7
SS-301	E-301	661.78	E-300	N/A	205	0.005	8	0.43	0.013	0.05	Bldg 83*, Bldg 77*, Bldg 19,
SS-302	E-302	N/A	E-301	691.94	15	0.01	6	0.28	0.013	0.05	Bldg 83*, Bldg 77*, Bldg 19
SS-303	E-303	664.27	E-302	N/A	190	0.01	6	0.28	0.001	0.00	Bldg 83*, Bldg 77*
SS-400	E-400	N/A	E-101	N/A	90	0.01	4	0.10	0.012	0.04	Bldg 76

\*Corresponding sanitary sewer flow rounded to the nearest 1/100 cfs. Contributing Facility produces a negligible sanitary sewer load. Refer to Table 1-1 for building load information in gallons per day (gpd) and cubic feet per second (cfs)

**Area F**

Pipe ID	Upstream Node	Upstream Invert	Downstream Node	Downstream Invert	Length (ft)	Slope (ft/ft)	Pipe Diameter (in.)	Q Capacity (cfs) (D/d = 0.5)	Q Average Daily (cfs)	Q Peak Daily (ADF <sub>x3.5</sub> )	Tributary Areas (Contributing to Upstream Node)
SS-101	F-101	659.65	F-100	N/A	70	0.01	6	0.28	0.002	0.01	Visitors Spectator Area**, Bldg 47*, Bldg 78
SS-102	F-102	N/A	F-101	659.73	50	0.01	6	0.28	0.000	0.00	Visitors Spectator Area**, Bldg 47*
SS-103	F-103	660.76	F-102	N/A	165	0.01	6	0.28	0.000	0.00	Visitors Spectator Area**
SS-104	F-104	N/A	F-103	660.76	260	0.01	6	0.28	0.000	0.00	Visitors Spectator Area**
SS-105	F-105	N/A	F-104	N/A	45	0.01	6	0.28	0.000	0.00	Visitors Spectator Area**

\*Corresponding sanitary sewer flow rounded to the nearest 1/100 cfs. Contributing Facility produces a negligible sanitary sewer load. Refer to Table 1-1 for building load information in gallons per day (gpd) and cubic feet per second (cfs)

\*\*Contributing facility produces a negligible sewer load.

Table 1-2: Existing Sanitary Sewer Model Data (Continued)

**Area G**

Pipe ID	Upstream Node	Upstream Invert	Downstream Node	Downstream Invert	Length (ft)	Slope (ft/ft)	Pipe Diameter (in.)	Q Capacity (cfs) (D/d = 0.5)	Q Average Daily (cfs)	Q Peak Daily (ADFx3.5)	Tributary Areas (Contributing to Upstream Node)
SS-101	G-101	N/A	G-100	N/A	25	0.01	4	0.10	0.000	0.00	Bldg 47*

\*Corresponding sanitary sewer flow rounded to the nearest 1/100 cfs. Contributing Facility produces a negligible sanitary sewer load. Refer to Table 1-1 for building load information in gallons per day (gpd) and cubic feet per second (cfs)

**Area H**

Pipe ID	Upstream Node	Upstream Invert	Downstream Node	Downstream Invert	Length (ft)	Slope (ft/ft)	Pipe Diameter (in.)	Q Capacity (cfs) (D/d = 0.5)	Q Average Daily (cfs)	Q Peak Daily (ADFx3.5)	Tributary Areas (Contributing to Upstream Node)
SS-101	H-101	N/A	H-100	N/A	70	0.01	4	0.10	0.006	0.02	Bldg 67

**Area J**

Pipe ID	Upstream Node	Upstream Invert	Downstream Node	Downstream Invert	Length (ft)	Slope (ft/ft)	Pipe Diameter (in.)	Q Capacity (cfs) (D/d = 0.5)	Q Average Daily (cfs)	Q Peak Daily (ADFx3.5)	Tributary Areas (Contributing to Upstream Node)
SS-101	J-101	661.51	J-100	660.01	250	0.006	6	0.22	0.000	0.00	Home Spectator Area**
SS-102	J-102	663.62	J-101	661.51	250	0.008	6	0.25	0.000	0.00	Home Spectator Area**
SS-103	J-103	N/A	J-102	663.62	64	0.01	6	0.28	0.000	0.00	Home Spectator Area**

\*\*Contributing facility produces a negligible sewer load.

Table 1-2: Existing Sanitary Sewer Model Data (Continued)

**Area K**

Pipe ID	Upstream Node	Upstream Invert	Downstream Node	Downstream Invert	Length (ft)	Slope (ft/ft)	Pipe Diameter (in.)	Q Capacity (cfs) (D/d = 0.5)	Q Average Daily (cfs)	Q Peak Daily (ADFx3.5)	Tributary Areas (Contributing to Upstream Node)
SS-101	K-101	N/A	K-100	N/A	150	0.01	8	0.60	0.125	0.44	Bldg 52, Bldg 53, Bldg 8/55, Bldg 56, Bldg 48, Bldg 9, Bldg B-82, Bldg 72, Bldg 73, Bldg 74, Bldg H-8, Bldg 67
SS-102	K-102	662.77	K-101	N/A	130	0.01	8	0.60	0.113	0.40	Bldg 52, Bldg 53, Bldg 8/55, Bldg 56, Bldg 48, Bldg 9, Bldg B-82, Bldg 72, Bldg 73, Bldg 74, Bldg H-8
SS-103	K-103	N/A	K-102	662.86	135	0.01	8	0.60	0.112	0.39	Bldg 52, Bldg 53, Bldg 8/55, Bldg 56, Bldg 48, Bldg 9, Bldg B-82, Bldg 72, Bldg 73, Bldg 74
SS-104	K-104	665.66	K-103	N/A	130	0.01	8	0.60	0.108	0.38	Bldg 52, Bldg 53, Bldg 8/55, Bldg 56, Bldg 48, Bldg 9, Bldg B-82
SS-200	K-200	667.36	K-104	665.73	165	0.01	8	0.60	0.067	0.23	Bldg 48, Bldg 9, Bldg F-12, Bldg F-11
SS-201	K-201	N/A	K-200	667.37	60	0.01	8	0.60	0.048	0.17	Bldg 48, Bldg 9, Bldg F-12, Bldg F-11
SS-202	K-202	N/A	K-201	N/A	30	0.01	8	0.60	0.027	0.09	Bldg 48, Bldg 9, Bldg F-12
SS-203	K-203	N/A	K-202	N/A	25	0.01	8	0.60	0.023	0.08	Bldg 48, Bldg 9, Bldg F-12
SS-204	K-204	N/A	K-203	N/A	105	0.01	8	0.60	0.014	0.05	Bldg 48, Bldg 9
SS-205	K-205	670.04	K-204	N/A	60	0.01	8	0.60	0.010	0.04	Bldg 48
SS-206	K-206	N/A	K-205	670.05	45	0.008	8	0.54	0.010	0.04	Bldg 48
SS-207	K-207	N/A	K-206	N/A	65	0.008	8	0.54	0.008	0.03	Bldg 48
SS-208	K-208	671.71	K-207	N/A	95	0.008	8	0.54	0.005	0.02	Bldg 48
SS-300	K-300	N/A	K-104	665.83	205	0.01	6	0.28	0.04	0.15	Bldg 52, Bldg 53, Bldg 8/55, Bldg 56
SS-301	K-301	N/A	K-300	N/A	15	0.01	6	0.28	0.04	0.12	Bldg 52, Bldg 53, Bldg 8/55, Bldg 56
SS-302	K-302	669.56	K-301	N/A	155	0.01	6	0.28	0.03	0.10	Bldg 52, Bldg 53, Bldg 8/55

**Area L**

Pipe ID	Upstream Node	Upstream Invert	Downstream Node	Downstream Invert	Length (ft)	Slope (ft/ft)	Pipe Diameter (in.)	Q Capacity (cfs) (D/d = 0.5)	Q Average Daily (cfs)	Q Peak Daily (ADFx3.5)	Tributary Areas (Contributing to Upstream Node)
SS-101	L-101	N/A	L-100	N/A	220	0.01	6	0.28	0.008	0.03	Bldg 75
SS-102	L-102	N/A	L-101	N/A	100	0.01	6	0.28	0.001	0.00	Bldg 75

**Area M**

Pipe ID	Upstream Node	Upstream Invert	Downstream Node	Downstream Invert	Length (ft)	Slope (ft/ft)	Pipe Diameter (in.)	Q Capacity (cfs) (D/d = 0.5)	Q Average Daily (cfs)	Q Peak Daily (ADFx3.5)	Tributary Areas (Contributing to Upstream Node)
SS-101	M-101	N/A	M-100	N/A	60	0.01	4	0.10	0.002	0.01	Bldg 70
SS-102	M-102	N/A	M-101	N/A	150	0.01	4	0.10	0.002	0.01	Bldg 70

Table 1-2: Existing Sanitary Sewer Model Data (Continued)

**Area N**

Pipe ID	Upstream Node	Upstream Invert	Downstream Node	Downstream Invert	Length (ft)	Slope (ft/ft)	Pipe Diameter (in.)	Q Capacity (cfs) (D/d = 0.5)	Q Average Daily (cfs)	Q Peak Daily (ADFx3.5)	Tributary Areas (Contributing to Upstream Node)
SS-101	N-101	N/A	N-100	N/A	200	0.01	6	0.28	0.006	0.02	Bldg V-70, Bldg V-71

**Area P**

Pipe ID	Upstream Node	Upstream Invert	Downstream Node	Downstream Invert	Length (ft)	Slope (ft/ft)	Pipe Diameter (in.)	Q Capacity (cfs) (D/d = 0.5)	Q Average Daily (cfs)	Q Peak Daily (ADFx3.5)	Tributary Areas (Contributing to Upstream Node)
SS-101	P-101	N/A	P-100	N/A	310	0.01	6	0.28	0.000	0.00	Dugout**

\*\*Contributing facility produces a negligible sewer load.

Table 1-3: Proposed Campus Sanitary Sewer Flow Allocation

Bldg No.	Building Name	Area (GSF)	Land Use (LU) Classification	Average Daily Flow (ADF) Rate (gpd/unit)	Average Daily Flow (ADF) Unit	Q Average Daily Flow (ADF) Rate (gpd)	Q Average Daily Flow (ADF) Rate (cfs)
3	FOREIGN LANGUAGE	16,130	Schl: Vocational	343	1000 GSF	5,531	0.009
6	ENGINEERING	24,145	Schl: Vocational	343	1000 GSF	8,280	0.013
7	SOUTH GYM	45,200	Gymnasium	300	1000 GSF	13,560	0.021
8	LIFE SCIENCE	20,660	Schl: Vocational	343	1000 GSF	7,086	0.011
11	MUSIC	16,441	Schl: Vocational	343	1000 GSF	5,638	0.009
19	BUSINESS & JOURNALISM	22,590	Schl: Vocational	343	1000 GSF	7,747	0.012
46	TICKET OFFICE / CONCESSION STAND RENOVATION	2,936	Retail	100	1000 GSF	294	0.000
48	ART	18,965	Schl: Vocational	343	1000 GSF	6,504	0.010
50	MATH SCIENCE	19,611	Schl: Vocational	343	1000 GSF	6,725	0.010
51	PLANETARIUM	2,616	Schl: Vocational	343	1000 GSF	897	0.001
52	BEHAVIORAL SCIENCE	13,700	Schl: Vocational	343	1000 GSF	4,698	0.007
53	HUMANITIES	19,400	Schl: Vocational	343	1000 GSF	6,653	0.010
54	MOTION PICTURES / TV STUDIO	4,700	Studio/Motion Picture	5	7 GSF	3,357	0.005
55	LIFE SCIENCE BUILDING STORAGE	198	Warehouse	25	1000 GSF	5	0.000
56	CAMPUS CENTER	83,553	Retail	100	1000 GSF	8,355	0.013
67	NORTH GYM	37,963	Gymnasium	300	1000 GSF	11,389	0.018
68	LIBRARY / ACADEMIC RESOURCE CENTER (LARC)	92,922	Library	25	1000 GSF	2,323	0.004
75	M&O-SHERIFF OFFICE	26,452	Office	200	1000 GSF	5,290	0.008
76	ALLIED HEALTH SCIENCE	80,767	Schl: Vocational	343	1000 GSF	27,697	0.043
77	CENTRAL POWER PLANT	5,694	MNFG/Industry	100	1000 GSF	569	0.001
102	STUDENT SERVICES CENTER	40,186	Office	200	1000 GSF	8,037	0.012
H-8	POOL EQUIPMENT BUILDING	1,992	Industrial	412	GPM Peak	412	.001
V-11	MEDIA ART CENTER	62,000	Schl: Vocational	343	1000 GSF	21,261	0.033
V-12	ADMINISTRATION / CWCD	79,486	Office	200	1000 GSF	15,897	0.025
V-13	ATHLETIC TRAINING FACILITY	18,000	Gymnasium	300	1000 GSF	5,400	0.008
V-14	BASEBALL FIELD HOUSE	10,000	Warehouse	25	1000 GSF	250	0.000
V-15	PERFORMANCE ARTS CENTER	21,693	Auditorium	5	Seat	4,250	0.007
V-16	MULTI-PURPOSE PE / COMMUNITY SERVICES CENTER	30,000	Gymnasium	300	1000 GSF	9,000	0.014
V-18	PARKING STRUCTURE	95,948	-	-	-	-	-
V-22	STUDENT UNION	53,538	Office	200	1000 GSF	10,708	0.017
V-51	PLANETARIUM EXPANSION	6,684	Schl: Vocational	343	1000 GSF	2,292	0.004
V-70	CHILD DEVELOPMENT & FAMILY COMPLEX	19,771	Schl: Vocational	10	Child	1,920	0.003
V-71	FAMILY RESOURCE CENTER	8,869	Office	200	1000 GSF	1,774	0.003
<b>TOTAL</b>		<b>1,002,612 GSF</b>				<b>213,388 gpd</b>	<b>0.330 cfs</b>

*(Page Intentionally Left Blank)*

Table 1-4: Proposed Sanitary Sewer Model Data

**Area A**

Pipe ID	Upstream Node	Upstream Invert	Downstream Node	Downstream Invert	Length (ft)	Slope (ft/ft)	Pipe Diameter (in.)	Q Capacity (cfs) (D/d = 0.5)	Q Average Daily (cfs)	Q Peak Daily (ADFx3.5)	Tributary Areas (Contributing to Upstream Node)
SS-101	A-101	664.63	A-100	N/A	172	0.01	8	0.60	0.081	0.28	Bldg V-12, Bldg 68, Bldg 54, Bldg 3, Bldg 6, Bldg 102, Bldg 51, Bldg V-51
SS-200	A-200	665.43	A-101	665.17	25	0.01	8	0.62	0.028	0.10	Bldg 102, Bldg 6, Bldg 51, Bldg V-51
SS-201	A-201	666.57	A-200	665.43	100	0.011	8	0.65	0.028	0.10	Bldg 102, Bldg 6, Bldg 51, Bldg V-51
SS-202	A-202	666.81	A-201	666.57	20	0.012	8	0.66	0.025	0.09	Bldg 102, Bldg 6, Bldg 51, Bldg V-51
SS-203	A-203	668.65	A-202	666.75	190	0.01	8	0.59	0.023	0.08	Bldg 102, Bldg 6, Bldg 51, Bldg V-51
SS-204	A-204	N/A	A-203	N/A	10	0.01	6	0.28	0.023	0.08	Bldg 102, Bldg 6, Bldg 51, Bldg V-51
SS-205	A-205	N/A	A-204	N/A	10	0.01	6	0.28	0.018	0.06	Bldg 102, Bldg 6
SS-206	A-206	N/A	A-205	N/A	5	0.01	6	0.28	0.005	0.02	Bldg 102
SS-207	A-207	N/A	A-206	N/A	30	0.01	6	0.28	0.002	0.01	Bldg 102
SS-300	A-300	N/A	A-101	N/A	100	0.01	4	0.10	0.011	0.04	Bldg 3, Bldg 102
SS-301	A-301	N/A	A-300	N/A	80	0.01	4	0.10	0.008	0.03	Bldg 3, Bldg 102
SS-302	A-302	N/A	A-301	N/A	80	0.01	4	0.10	0.003	0.01	Bldg 3
SS-400	A-400	667.64	A-101	664.74	290	0.01	8	0.60	0.042	0.15	Bldg V-12, Bldg 68, Bldg 54, Bldg 11
SS-401	A-401	669.29	A-400	667.65	220	0.007	8	0.52	0.018	0.06	Bldg 68, Bldg 54, Bldg 11
SS-402	A-402	671.15	A-401	669.37	140	0.013	6	0.32	0.018	0.06	Bldg 68, Bldg 54, Bldg 11
SS-403	A-403	672.09	A-402	671.15	75	0.013	6	0.31	0.018	0.06	Bldg 68, Bldg 54, Bldg 11
SS-404	A-404	674.39	A-403	672.28	210	0.01	8	0.61	0.014	0.05	Bldg 54, Bldg 11
SS-405	A-405	674.97	A-404	674.39	60	0.01	8	0.59	0.014	0.05	Bldg 54, Bldg 11
SS-406	A-406	676.89	A-405	674.98	185	0.01	8	0.61	0.014	0.05	Bldg 54, Bldg 11
SS-407	A-407	N/A	A-406	N/A	16	0.005	8	0.43	0.014	0.05	Bldg 54, Bldg 11
SS-408	A-408	N/A	A-407	N/A	40	0.005	8	0.43	0.010	0.03	Bldg 54, Bldg 11(p)

Table 1-4: Proposed Sanitary Sewer Model Data (Continued)

**Area C**

Pipe ID	Upstream Node	Upstream Invert	Downstream Node	Downstream Invert	Length (ft)	Slope (ft/ft)	Pipe Diameter (in.)	Q Capacity (cfs) (D/d = 0.5)	Q Average Daily (cfs)	Q Peak Daily (ADFx3.5)	Tributary Areas (Contributing to Upstream Node)
SS-101	C-101	N/A	C-100	N/A	120	0.015	6	0.30	0.047	0.16	Bldg 50, Bldg 76
SS-102	C-102	N/A	C-101	N/A	200	0.015	6	0.30	0.010	0.04	Bldg 50
SS-103	C-103	N/A	C-102	N/A	65	0.014	4	0.10	0.010	0.04	Bldg 50
SS-104	C-104	N/A	C-103	N/A	70	0.017	4	0.10	0.010	0.04	Bldg 50
SS-105	C-105	N/A	C-104	N/A	40	0.017	4	0.11	0.010	0.04	Bldg 50
SS-106	C-106	N/A	C-105	N/A	175	0.017	4	0.11	0.010	0.04	Bldg 50
SS-107	C-107	N/A	C-106	N/A	110	0.017	4	0.11	0.010	0.04	Bldg 50
SS-108	C-108	N/A	C-107	N/A	15	0.017	4	0.11	0.010	0.04	Bldg 50
SS-109	C-109	N/A	C-108	N/A	90	0.01	4	0.12	0.010	0.04	Bldg 50
SS-200	C-200	N/A	C-101	N/A	45	0.01	6	0.24	0.031	0.11	Bldg 76

**Area E**

Pipe ID	Upstream Node	Upstream Invert	Downstream Node	Downstream Invert	Length (ft)	Slope (ft/ft)	Pipe Diameter (in.)	Q Capacity (cfs) (D/d = 0.5)	Q Average Daily (cfs)	Q Peak Daily (ADFx3.5)	Tributary Areas (Contributing to Upstream Node)
SS-101	E-101	N/A	E-100	658.06	50	0.005	8	0.43	0.046	0.16	Bldg 7, Bldg 83, Bldg 77, Bldg 19, Bldg 76,
SS-200	E-200	N/A	E-101	N/A	65	0.01	6	0.28	0.013	0.05	Bldg 7
SS-201	E-201	N/A	E-200	N/A	15	0.01	6	0.28	0.010	0.03	Bldg 7
SS-202	E-202	N/A	E-201	N/A	60	0.01	6	0.28	0.008	0.03	Bldg 7
SS-203	E-203	N/A	E-202	N/A	90	0.01	6	0.28	0.005	0.02	Bldg 7
SS-204	E-204	N/A	E-203	N/A	105	0.01	4	0.10	0.005	0.02	Bldg 7
SS-205	E-205	N/A	E-204	N/A	30	0.01	4	0.10	0.003	0.01	Bldg 7
SS-206	E-206	N/A	E-205	N/A	30	0.01	4	0.10	0.002	0.01	Bldg 7
SS-300	E-300	N/A	E-101	N/A	150	0.005	8	0.43	0.021	0.07	Bldg 83*, Bldg 77*, Bldg 19, Bldg 7
SS-301	E-301	661.78	E-300	N/A	205	0.005	8	0.43	0.013	0.05	Bldg 83*, Bldg 77*, Bldg 19,
SS-302	E-302	N/A	E-301	691.94	15	0.01	6	0.28	0.013	0.05	Bldg 83*, Bldg 77*, Bldg 19
SS-303	E-303	664.27	E-302	N/A	190	0.01	6	0.28	0.001	0.00	Bldg 83*, Bldg 77*
SS-400	E-400	N/A	E-101	N/A	90	0.01	4	0.10	0.012	0.04	Bldg 76

\*Corresponding sanitary sewer flow rounded to the nearest 1/100 cfs. Contributing Facility produces a negligible sanitary sewer load. Refer to Table 1-3 for building load information in gallons per day (gpd) and cubic feet per second (cfs)

Table 1-4: Proposed Sanitary Sewer Model Data (Continued)

**Area F**

Pipe ID	Upstream Node	Upstream Invert	Downstream Node	Downstream Invert	Length (ft)	Slope (ft/ft)	Pipe Diameter (in.)	Q Capacity (cfs) (D/d = 0.5)	Q Average Daily (cfs)	Q Peak Daily (ADF <sub>x3.5</sub> )	Tributary Areas (Contributing to Upstream Node)
SS-101	F-101	659.65	F-100	N/A	70	0.01	6	0.28	0.000	0.00	Visitors Spectator Area**
SS-102	F-102	N/A	F-101	659.73	50	0.01	6	0.28	0.000	0.00	Visitors Spectator Area**
SS-103	F-103	660.76	F-102	N/A	165	0.01	6	0.28	0.000	0.00	Visitors Spectator Area**
SS-104	F-104	N/A	F-103	660.76	260	0.01	6	0.28	0.000	0.00	Visitors Spectator Area**
SS-105	F-105	N/A	F-104	N/A	45	0.01	6	0.28	0.000	0.00	Visitors Spectator Area**

\*\*Contributing facility produces a negligible sewer load.

**Area H**

Pipe ID	Upstream Node	Upstream Invert	Downstream Node	Downstream Invert	Length (ft)	Slope (ft/ft)	Pipe Diameter (in.)	Q Capacity (cfs) (D/d = 0.5)	Q Average Daily (cfs)	Q Peak Daily (ADF <sub>x3.5</sub> )	Tributary Areas (Contributing to Upstream Node)
SS-101	H-101	N/A	H-100	N/A	70	0.01	4	0.10	0.006	0.02	Bldg 67

**Area J**

Pipe ID	Upstream Node	Upstream Invert	Downstream Node	Downstream Invert	Length (ft)	Slope (ft/ft)	Pipe Diameter (in.)	Q Capacity (cfs) (D/d = 0.5)	Q Average Daily (cfs)	Q Peak Daily (ADF <sub>x3.5</sub> )	Tributary Areas (Contributing to Upstream Node)
SS-101	J-101	N/A	J-100	N/A	51	0.01	6	0.28	0.016	0.06	Home Spectator Area**, V-16, V-13, B-46
SS-102	J-102	N/A	J-101	N/A	194	0.01	6	0.28	0.016	0.06	Home Spectator Area**, V-16, V-13, B-46
SS-103	J-103	N/A	J-102	N/A	194	0.01	6	0.28	0.007	0.02	Home Spectator Area**, V-16
SS-104	J-104	N/A	J-103	N/A	249	0.01	6	0.28	0.000	0.00	Home Spectator Area**

\*\*Contributing facility produces a negligible sewer load.

Table 1-4: Proposed Sanitary Sewer Model Data (Continued)

**Area K**

Pipe ID	Upstream Node	Upstream Invert	Downstream Node	Downstream Invert	Length (ft)	Slope (ft/ft)	Pipe Diameter (in.)	Q Capacity (cfs) (D/d = 0.5)	Q Average Daily (cfs)	Q Peak Daily (ADFx3.5)	Tributary Areas (Contributing to Upstream Node)
SS-101	K-101	N/A	K-100	N/A	150	0.01	8	0.60	0.120	0.42	Bldg 52, Bldg 53, Bldg 56, Bldg V-22, V-11, Bldg V-15, Bldg 48, Bldg H-8, Bldg 67, Bldg 8/55
SS-102	K-102	662.77	K-101	N/A	130	0.01	8	0.60	0.108	0.38	Bldg 52, Bldg 53, Bldg 56, Bldg V-22, V-11, Bldg V-15, Bldg 48, Bldg H-8, Bldg 8/55
SS-103	K-103	N/A	K-102	662.86	135	0.01	8	0.60	0.108	0.38	Bldg 52, Bldg 53, Bldg 56, V-22, Bldg 48, V-11, Bldg V-15, Bldg 48, Bldg 8/55
SS-104	K-104	665.66	K-103	N/A	130	0.01	8	0.60	0.058	0.20	Bldg 52, Bldg 53, Bldg 56, V-22, Bldg 8/55
SS-200	K-200	667.36	K-104	665.73	165	0.01	8	0.60	0.017	0.06	Bldg V-22
SS-201	K-201	N/A	K-200	667.37	60	0.01	8	0.60	0.017	0.06	Bldg V-22
SS-300	K-300	N/A	K-104	665.83	205	0.01	6	0.28	0.04	0.15	Bldg 52, Bldg 53, Bldg 56, Bldg 8/55
SS-301	K-301	N/A	K-300	N/A	15	0.01	6	0.28	0.03	0.12	Bldg 52, Bldg 53, Bldg 56, Bldg 8/55
SS-302	K-302	669.56	K-301	N/A	155	0.01	6	0.28	0.03	0.10	Bldg 52, Bldg 53, Bldg 8/55
SS-400	K-400	N/A	K-103	N/A	456	0.005	8	0.56	0.05	0.17	Bldg V-15, Bldg 48, V-11
SS-401	K-401	N/A	K-400	N/A	175	0.005	8	0.56	0.05	0.17	Bldg V-15, Bldg 48, V-11
SS-402	K-402	N/A	K-401	N/A	46	0.005	8	0.56	0.05	0.17	Bldg V-15, Bldg 48, V-11
SS-403	K-403	N/A	K-402	N/A	65	0.005	8	0.56	0.05	0.16	Bldg V-15, Bldg 48, V-11
SS-404	K-404	N/A	K-403	N/A	92	0.005	8	0.56	0.04	0.16	Bldg V-15, Bldg 48, V-11
SS-405	K-405	N/A	K-404	N/A	131	0.005	8	0.56	0.04	0.14	Bldg V-15, V-11

**Area L**

Pipe ID	Upstream Node	Upstream Invert	Downstream Node	Downstream Invert	Length (ft)	Slope (ft/ft)	Pipe Diameter (in.)	Q Capacity (cfs) (D/d = 0.5)	Q Average Daily (cfs)	Q Peak Daily (ADFx3.5)	Tributary Areas (Contributing to Upstream Node)
SS-101	L-101	N/A	L-100	N/A	220	0.01	6	0.28	0.008	0.03	Bldg 75
SS-102	L-102	N/A	L-101	N/A	100	0.01	6	0.28	0.001	0.00	Bldg 75

**Area N**

Pipe ID	Upstream Node	Upstream Invert	Downstream Node	Downstream Invert	Length (ft)	Slope (ft/ft)	Pipe Diameter (in.)	Q Capacity (cfs) (D/d = 0.5)	Q Average Daily (cfs)	Q Peak Daily (ADFx3.5)	Tributary Areas (Contributing to Upstream Node)
SS-101	N-101	N/A	N-100	N/A	200	0.01	6	0.28	0.006	0.02	Bldg V-70, Bldg V-71

Table 1-4: Proposed Sanitary Sewer Model Data (Continued)

**Area P**

Pipe ID	Upstream Node	Upstream Invert	Downstream Node	Downstream Invert	Length (ft)	Slope (ft/ft)	Pipe Diameter (in.)	Q Capacity (cfs) (D/d = 0.5)	Q Average Daily (cfs)	Q Peak Daily (ADFx3.5)	Tributary Areas (Contributing to Upstream Node)
SS-101	P-101	N/A	P-100	N/A	310	0.01	6	0.28	0.000	0.00	Bldg V-14*

\*Corresponding sanitary sewer flow rounded to the nearest 1/100 cfs. Contributing Facility produces a negligible sanitary sewer load. Refer to Table 1-3 for building load information in gallons per day (gpd) and cubic feet per second (cfs)

*(Page Intentionally Left Blank)*



**LEGEND:**

- EXISTING BUILDING
- AREA A
- AREA B
- AREA C & D
- AREA E
- AREA F, G & J
- AREA H & K
- AREA L
- AREA M & N
- AREA P

**NOTE:**  
 1. REFER TO TABLES ES-1 AND ES-2 FOR BUILDING NAMES.

FIGURE 1c  
 EXISTING SANITARY SEWER PIPE AND NODE KEY MAP

*(Page Intentionally Left Blank)*

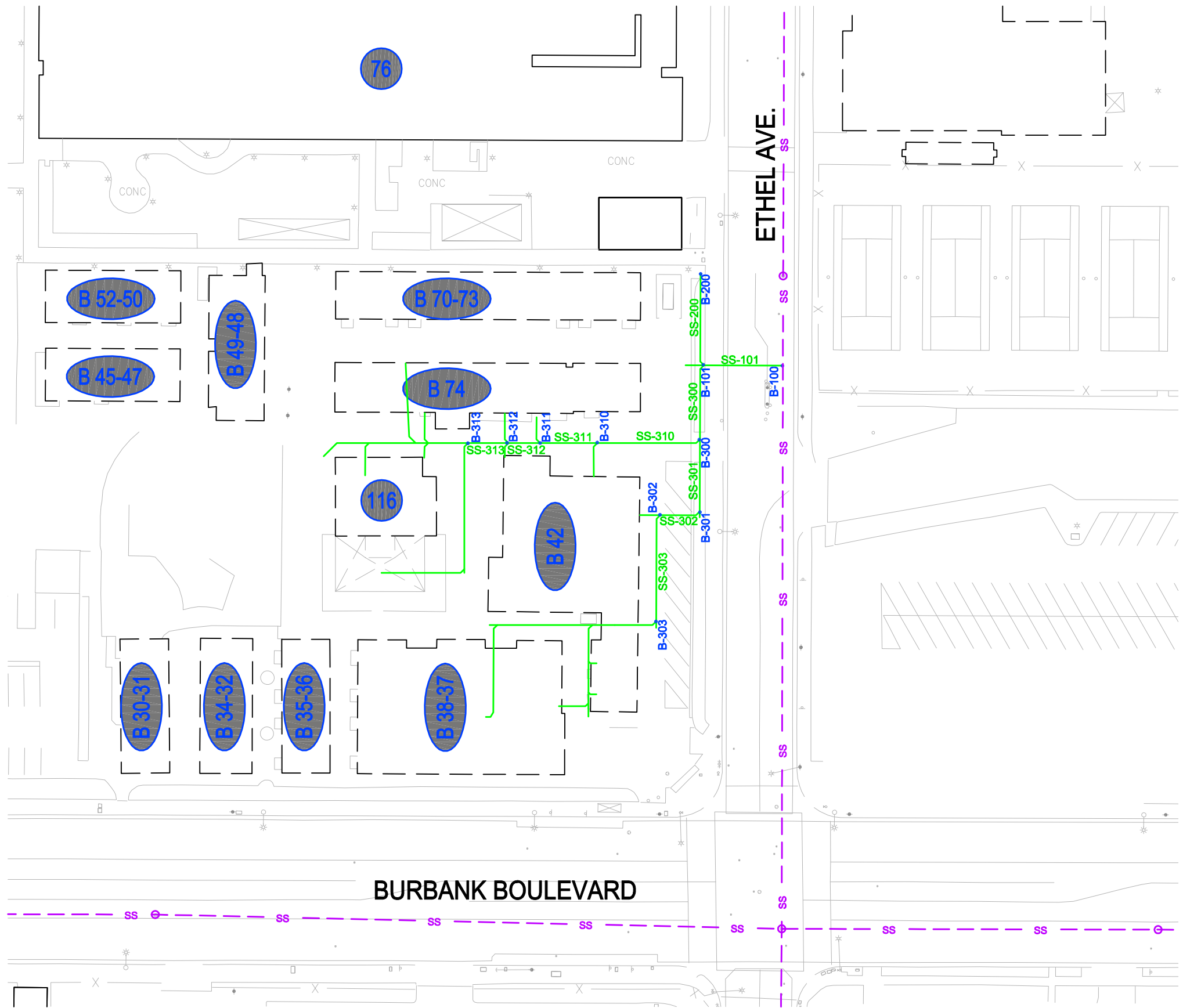


- LEGEND:**
- SANITARY SEWER PIPE
  - EXISTING SANITARY SEWER
  - SANITARY SEWER NODE



FIGURE 1d  
EXISTING SANITARY SEWER - PIPE AND NODE MAP AREA A

*(Page Intentionally Left Blank)*



- LEGEND:**
- SANITARY SEWER PIPE
  - - - EXISTING SANITARY SEWER
  - SANITARY SEWER NODE



FIGURE 1e  
 EXISTING SANITARY SEWER - PIPE AND NODE MAP AREA B

*(Page Intentionally Left Blank)*

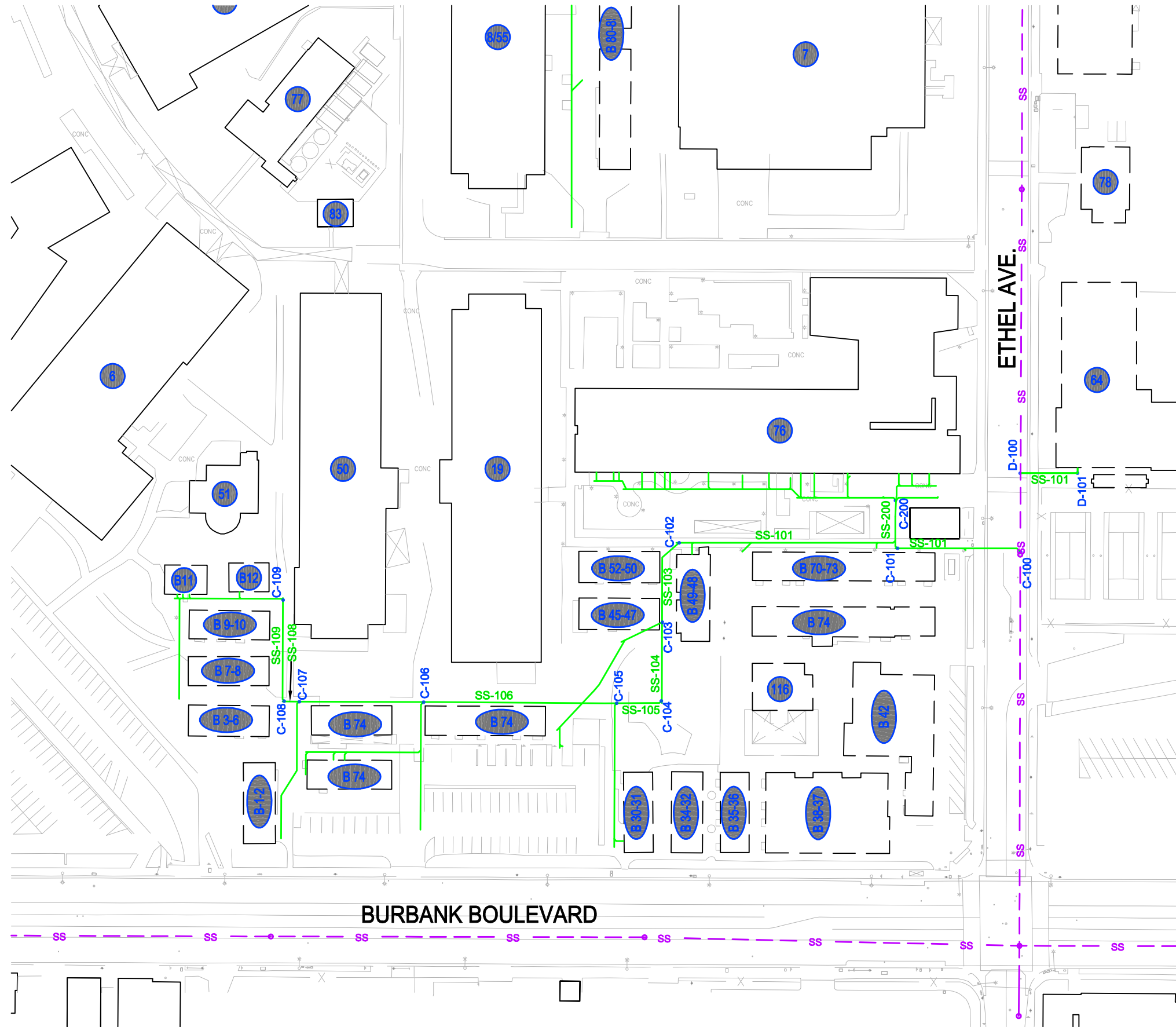
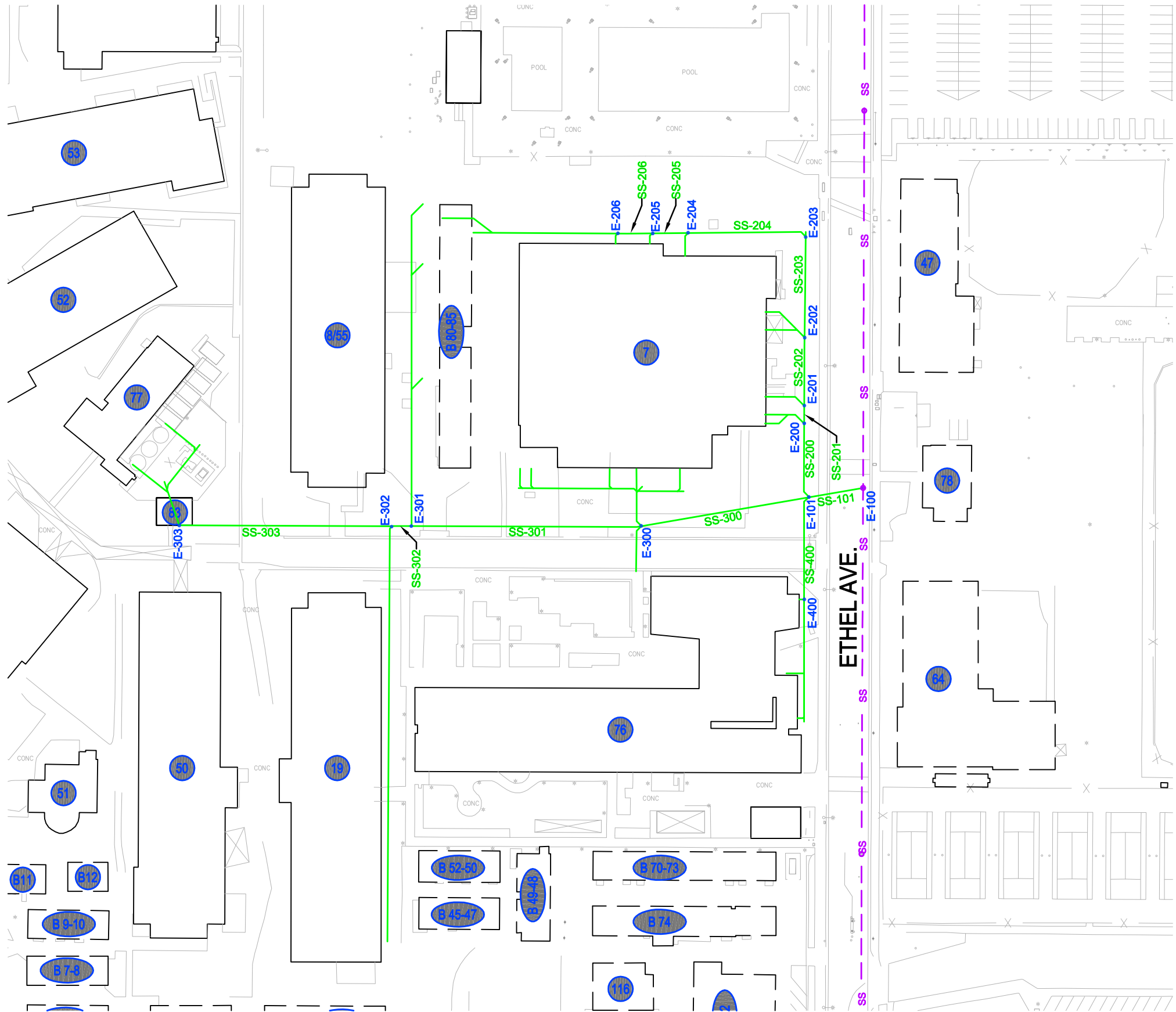


FIGURE 1f  
 EXISTING SANITARY SEWER - PIPE AND NODE MAP AREAS C AND D

*(Page Intentionally Left Blank)*

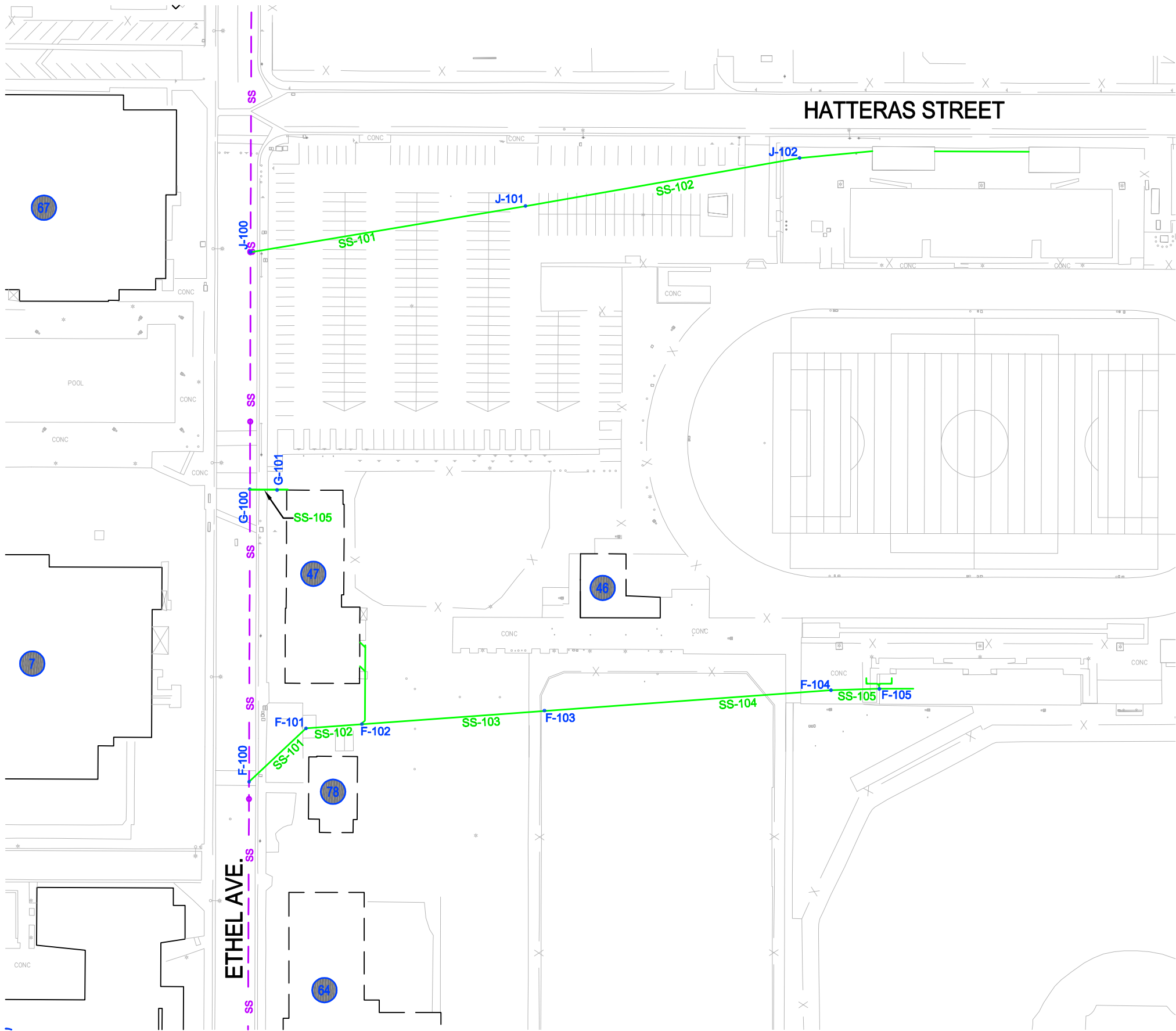


- LEGEND:**
- SANITARY SEWER PIPE
  - - - EXISTING SANITARY SEWER
  - SANITARY SEWER NODE



FIGURE 1g  
 EXISTING SANITARY SEWER - PIPE AND NODE MAP AREA E

*(Page Intentionally Left Blank)*



- LEGEND:**
- SANITARY SEWER PIPE
  - - - ■ EXISTING SANITARY SEWER
  - SANITARY SEWER NODE



FIGURE 1h  
EXISTING SANITARY SEWER - PIPE AND NODE MAP AREAS F , G AND J

*(Page Intentionally Left Blank)*






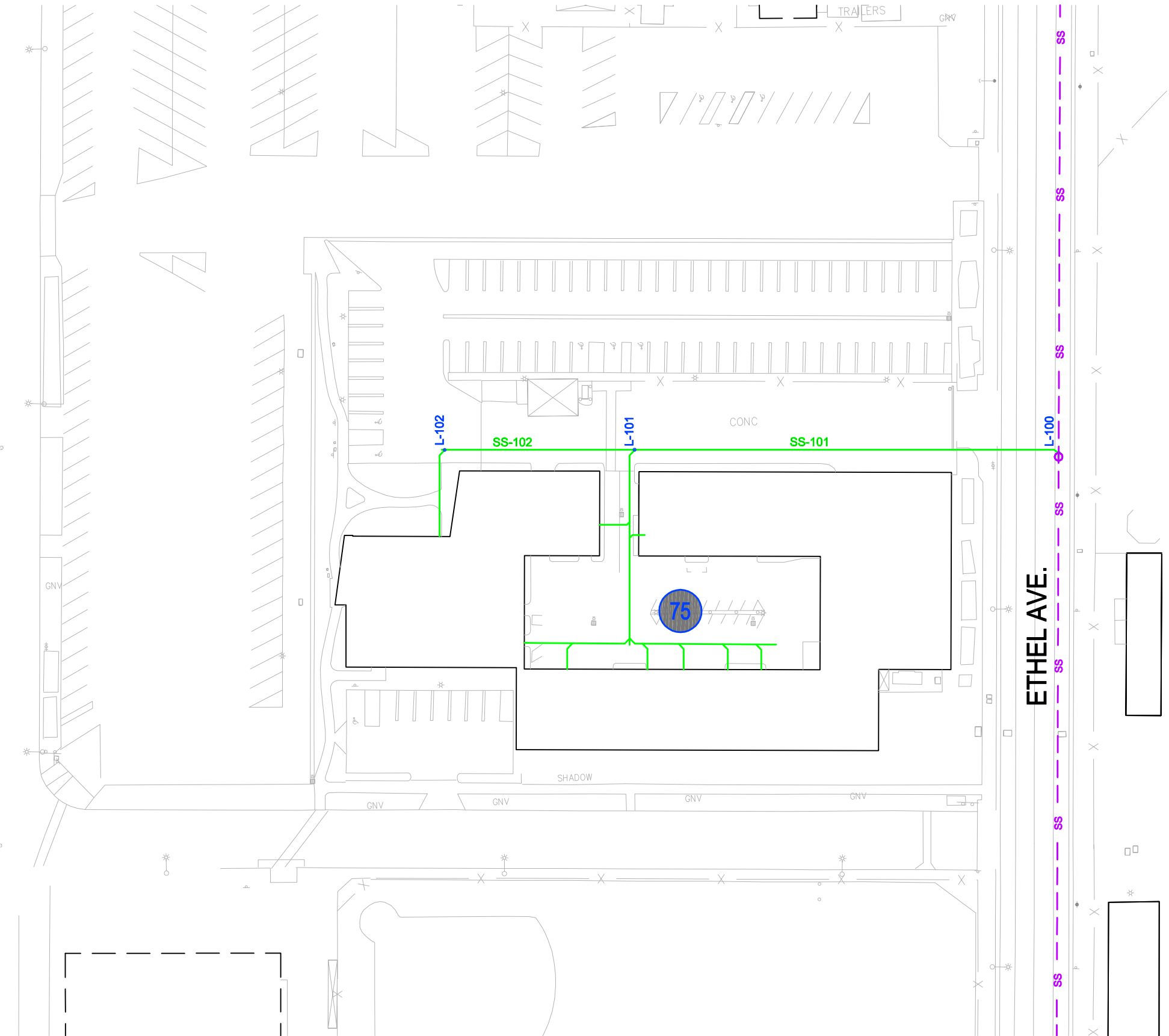
- LEGEND:**
-  SANITARY SEWER PIPE
  -  EXISTING SANITARY SEWER
  -  SANITARY SEWER NODE

FIGURE 1j  
EXISTING SANITARY SEWER - PIPE AND NODE MAP AREAS H AND K

*(Page Intentionally Left Blank)*

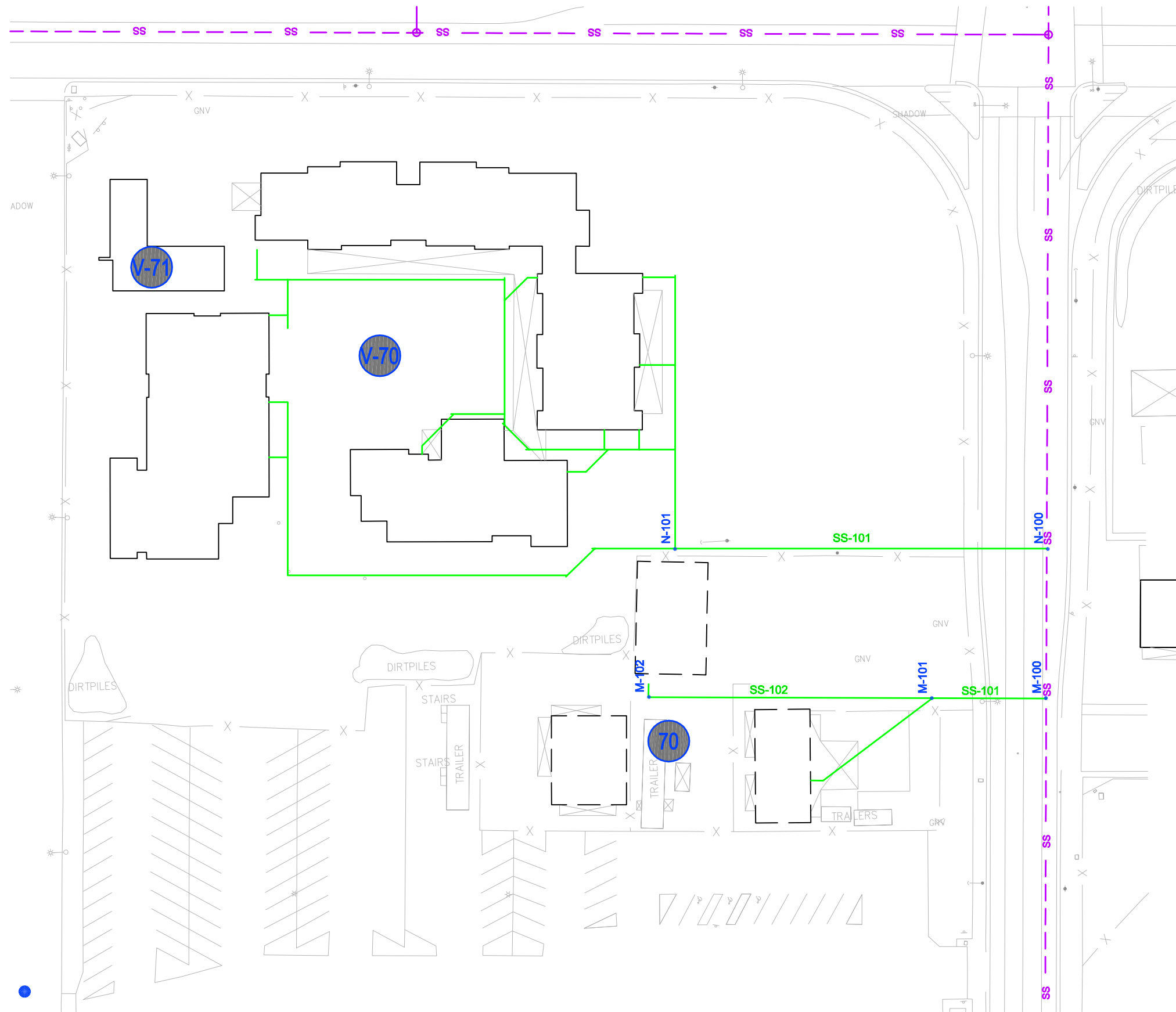


- LEGEND:**
- SANITARY SEWER PIPE
  - - EXISTING SANITARY SEWER
  - SANITARY SEWER NODE



FIGURE 1k  
 EXISTING SANITARY SEWER - PIPE AND NODE MAP AREA L

*(Page Intentionally Left Blank)*

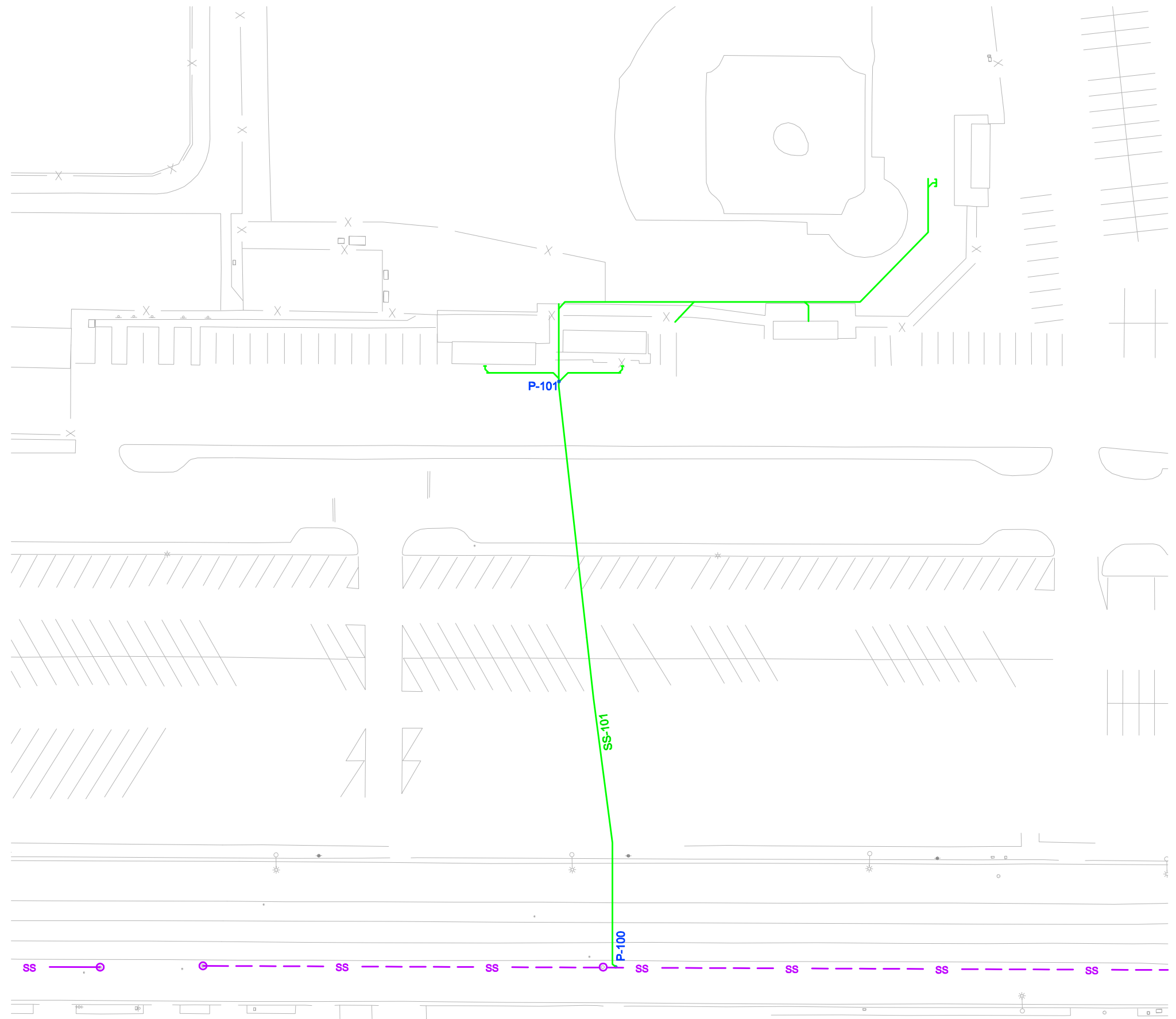


- LEGEND:**
- SANITARY SEWER PIPE
  - EXISTING SANITARY SEWER
  - SANITARY SEWER NODE



FIGURE 11  
EXISTING SANITARY SEWER - PIPE AND NODE MAP AREAS M AND N

*(Page Intentionally Left Blank)*

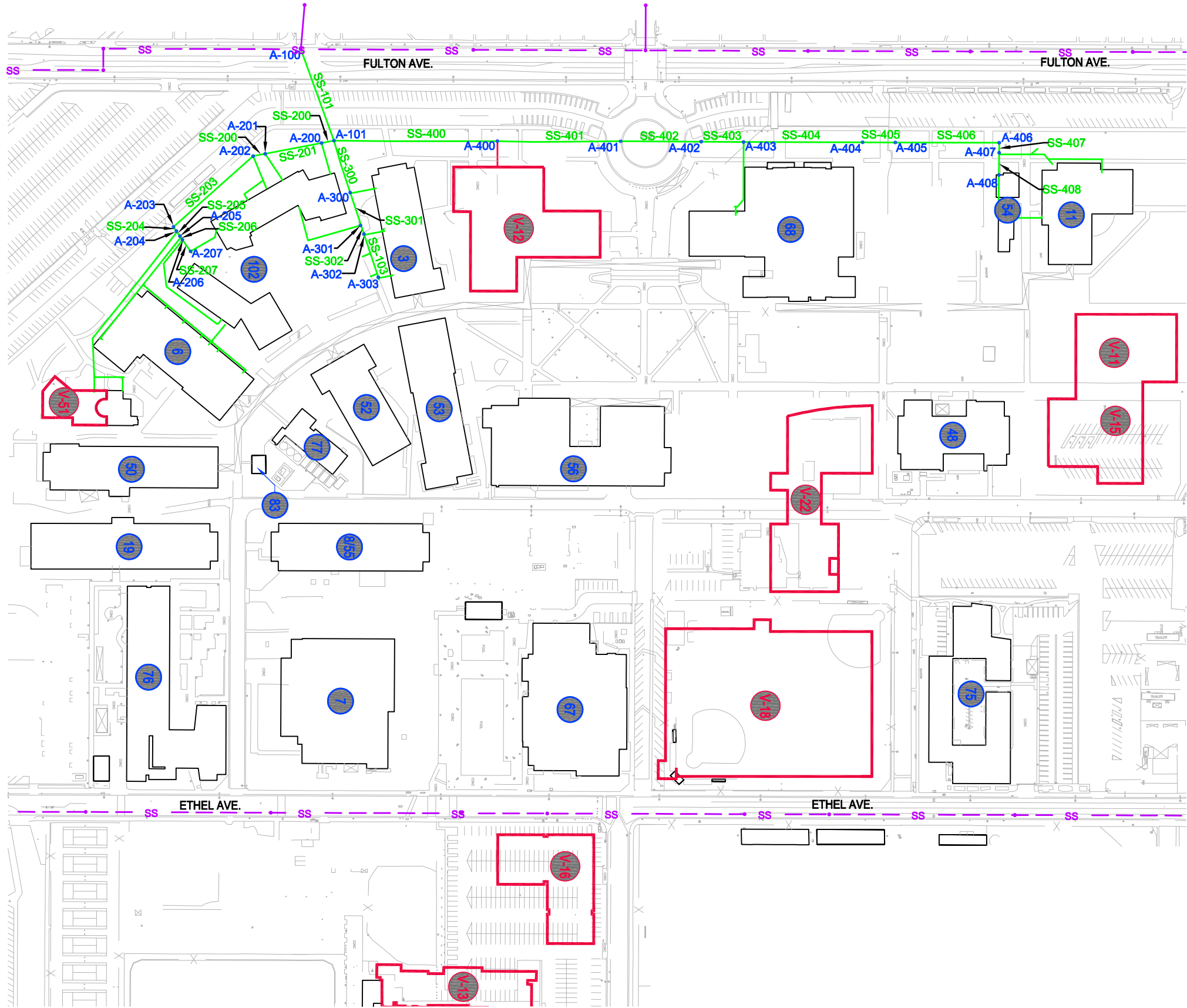


- LEGEND:**
- SANITARY SEWER PIPE
  - EXISTING SANITARY SEWER
  - SANITARY SEWER NODE



FIGURE 1m  
EXISTING SANITARY SEWER - PIPE AND NODE MAP AREA P

*(Page Intentionally Left Blank)*

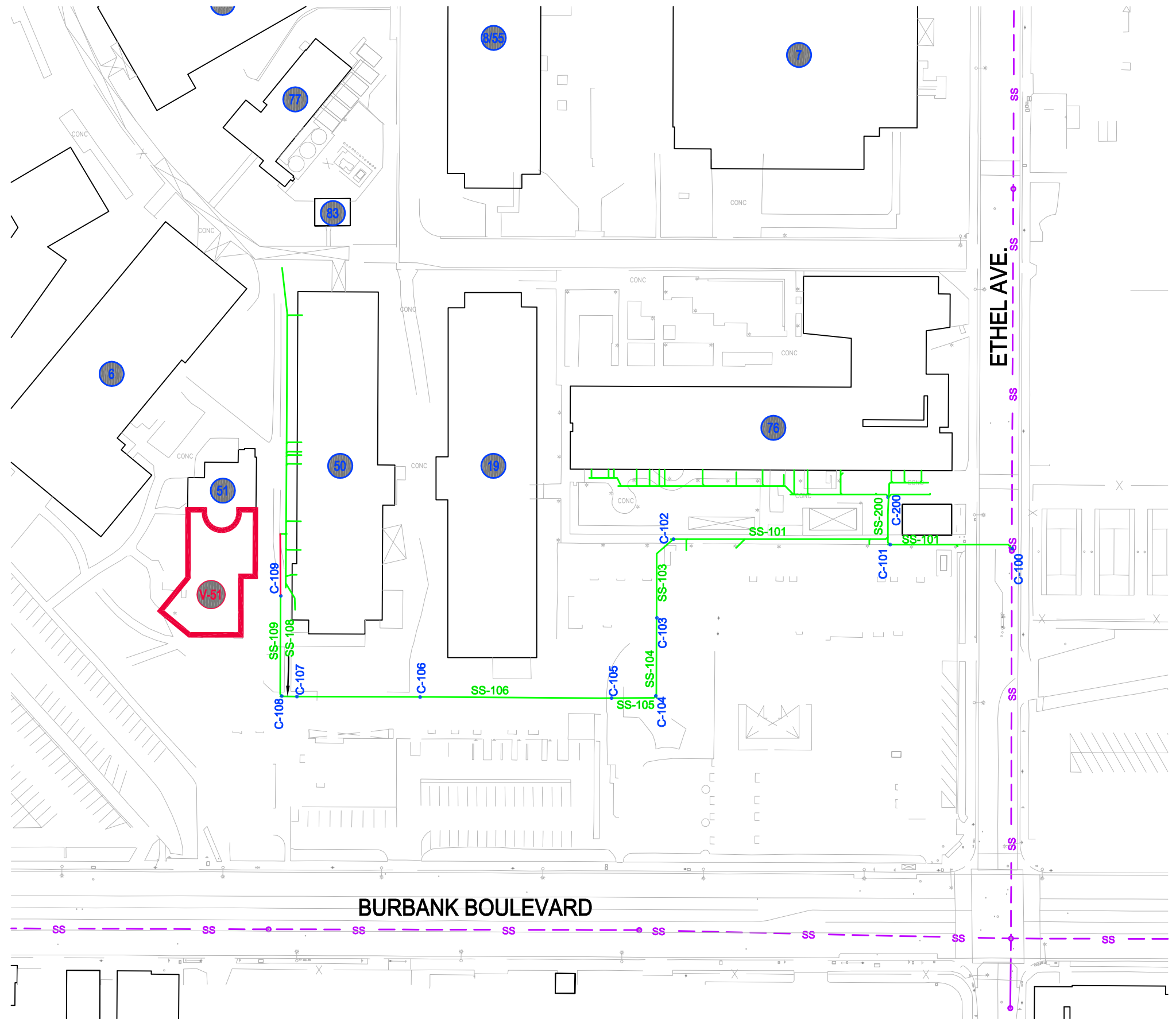


- LEGEND:**
- SANITARY SEWER PIPE
  - PROPOSED SANITARY SEWER PIPE
  - - EXISTING SANITARY SEWER
  - SANITARY SEWER NODE



FIGURE 1n  
 PROPOSED SANITARY SEWER - PIPE AND NODE MAP AREA A

*(Page Intentionally Left Blank)*

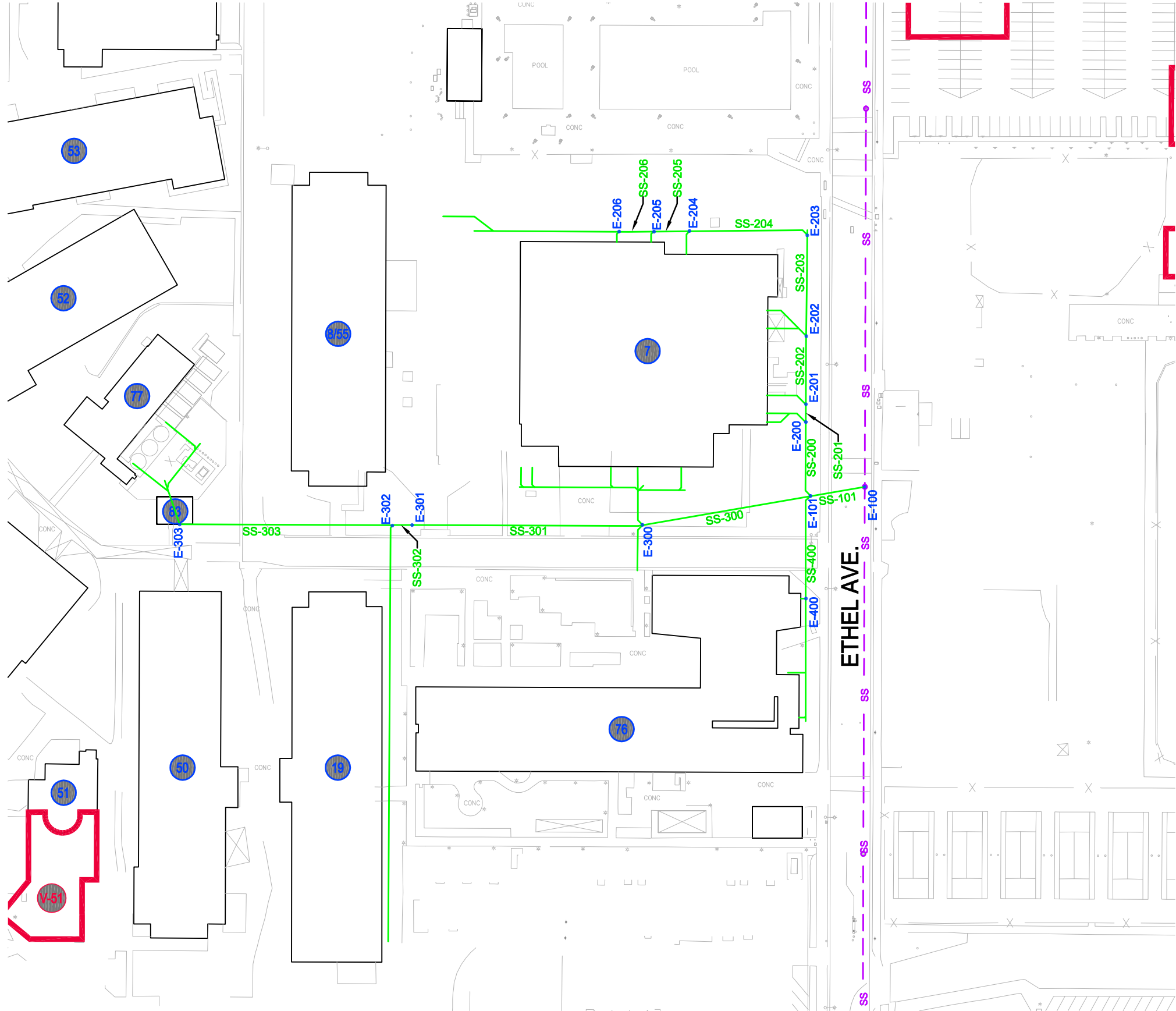


- LEGEND:**
- SANITARY SEWER PIPE
  - PROPOSED SANITARY SEWER PIPE
  - - EXISTING SANITARY SEWER
  - SANITARY SEWER NODE



FIGURE 1p  
PROPOSED SANITARY SEWER - PIPE AND NODE MAP AREA C

*(Page Intentionally Left Blank)*

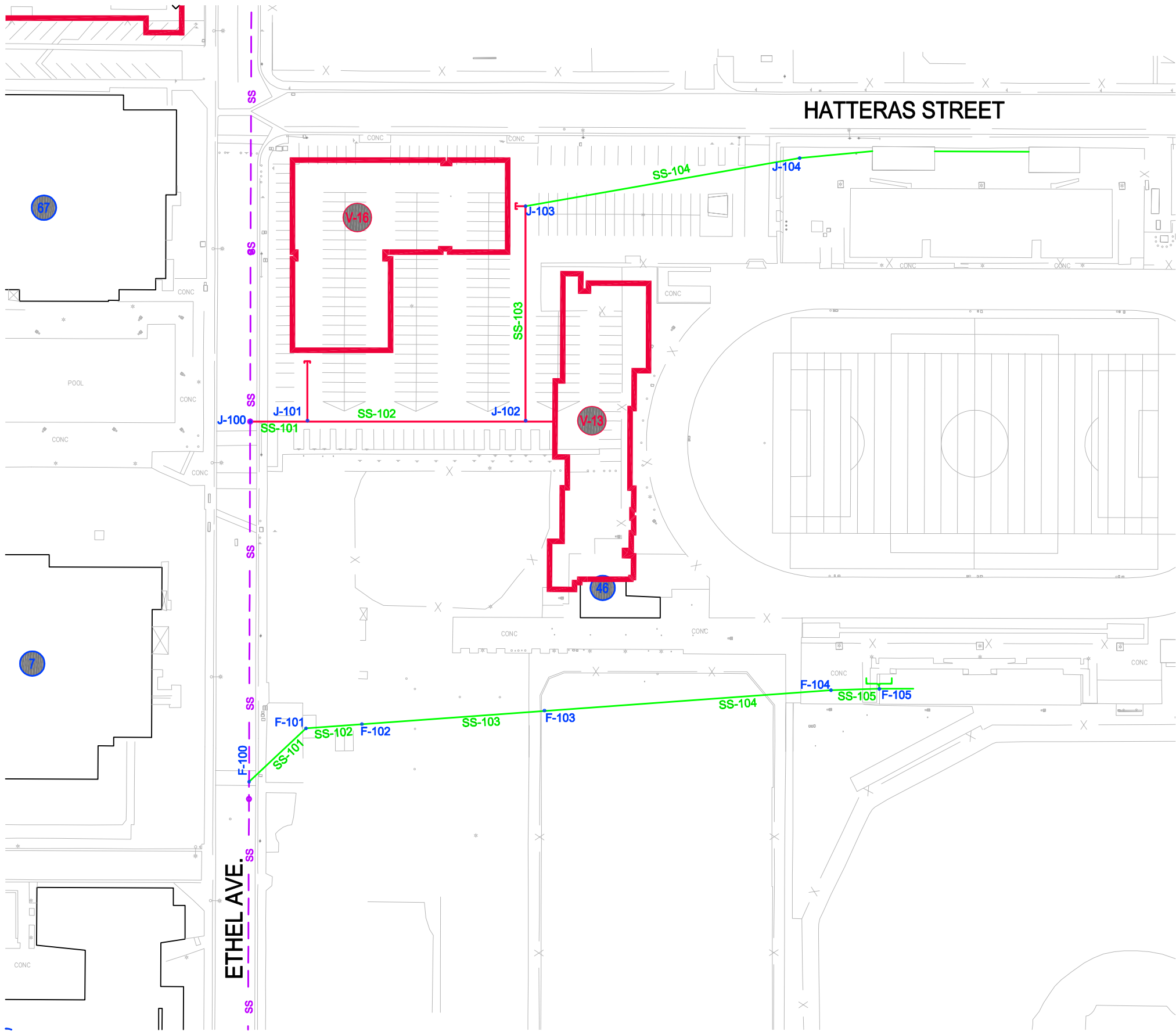


- LEGEND:**
- SANITARY SEWER PIPE
  - PROPOSED SANITARY SEWER PIPE
  - - EXISTING SANITARY SEWER
  - SANITARY SEWER NODE



FIGURE 1q  
PROPOSED SANITARY SEWER - PIPE AND NODE MAP AREA E

*(Page Intentionally Left Blank)*

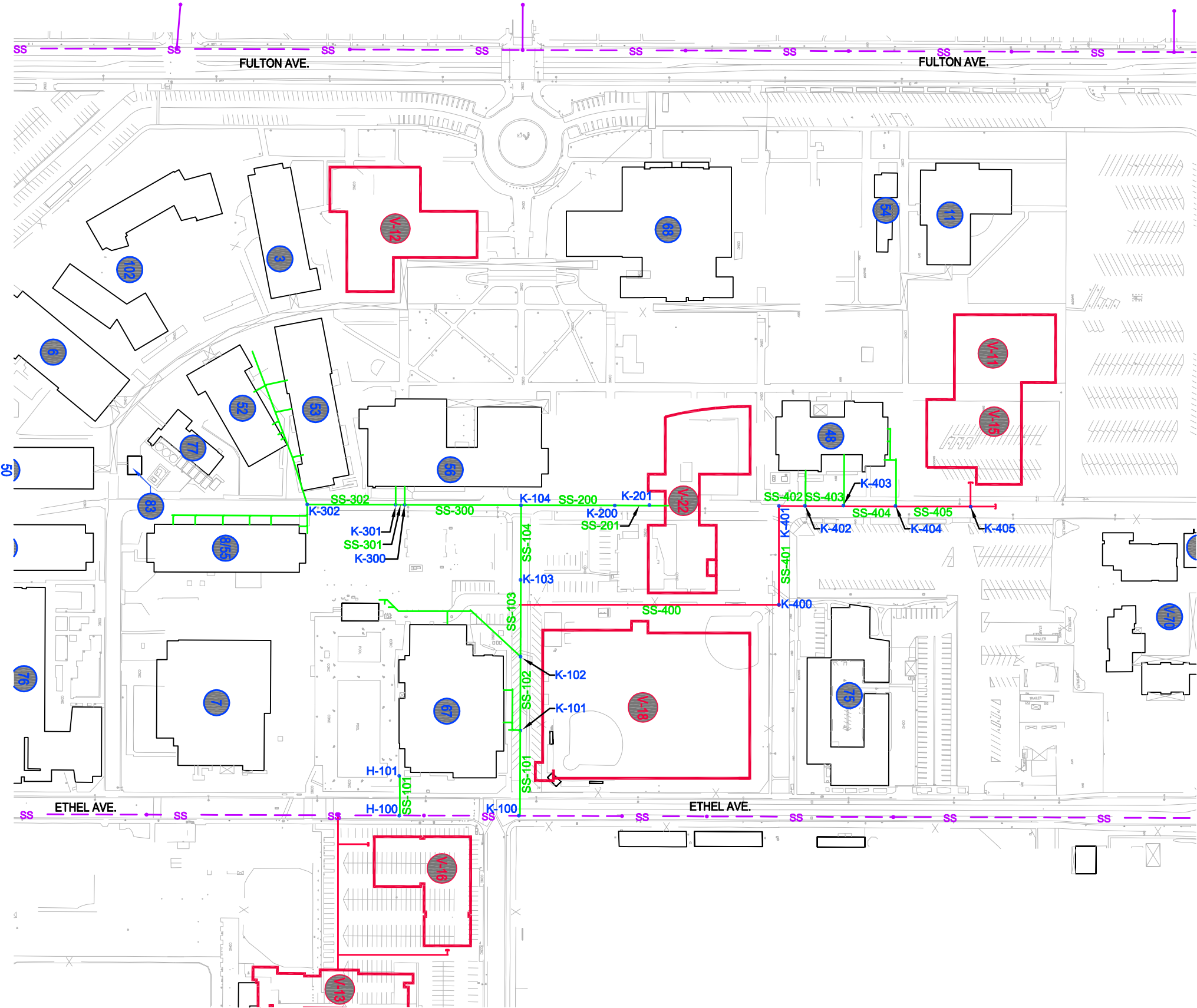


- LEGEND:**
- SANITARY SEWER PIPE
  - PROPOSED SANITARY SEWER PIPE
  - - EXISTING SANITARY SEWER
  - SANITARY SEWER NODE



FIGURE 1r  
 PROPOSED SANITARY SEWER - PIPE AND NODE MAP AREAS F AND J

*(Page Intentionally Left Blank)*







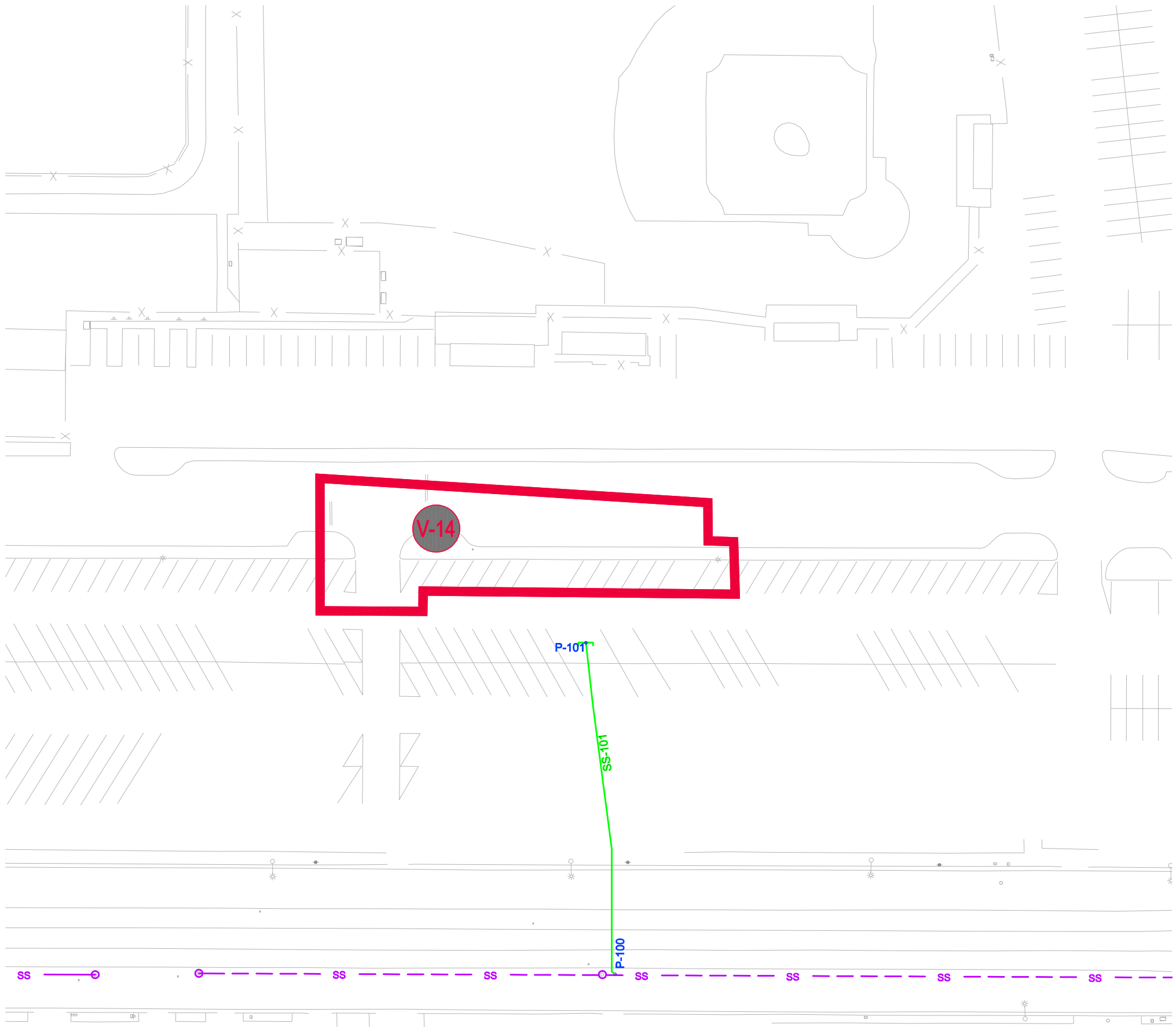
- LEGEND:**
-  SANITARY SEWER PIPE
  -  PROPOSED SANITARY SEWER PIPE
  -  EXISTING SANITARY SEWER
  -  SANITARY SEWER NODE



FIGURE 1s  
PROPOSED SANITARY SEWER - PIPE AND NODE MAP AREAS H AND K

*(Page Intentionally Left Blank)*







- LEGEND:**
-  SANITARY SEWER PIPE
  -  PROPOSED SANITARY SEWER PIPE
  -  EXISTING SANITARY SEWER
  -  SANITARY SEWER NODE

FIGURE 1t  
PROPOSED SANITARY SEWER - PIPE AND NODE MAP AREA P



*(Page Intentionally Left Blank)*

## SECTION 2 – STORM DRAIN SYSTEM

### 2.1 EXISTING SYSTEM DESCRIPTION

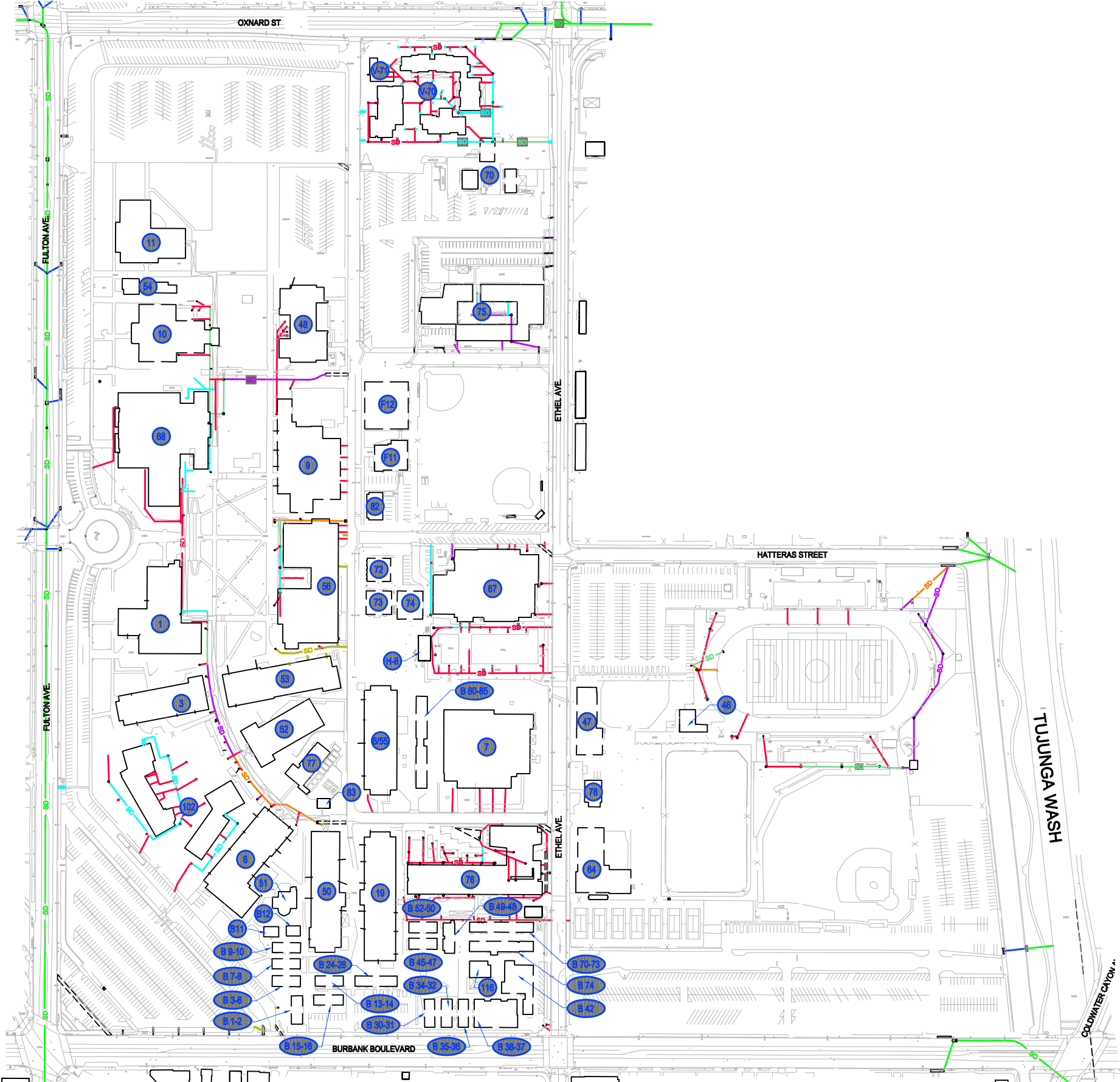
The existing campus storm drain system consists of various underground pipe networks which discharge to the campus roadways and City of LA roadways surrounding the campus.










The following is a summary of the on-site storm water collection system:

- Storm water from the western and center portions of campus is collected through a series of catch basins and underground pipes which discharge to Campus Road and then to Ethel Ave. Roof drains from buildings are collected and also discharged to Campus Road.
- The Allied Health Building site development includes a storm water treatment feature which detains and treats storm water from the site and building roof drains.
- The north and south gym complex collects storm water through catch basins and underground pipes and discharges directly to Ethel Ave.
- Storm water from existing surface parking lots surface flow to their adjacent and surrounding roadways.
- Storm water from the northern portion of the Athletic Complex east of Ethel Ave. is collected on-site and discharged to the City of LA storm drain in Hatteras St. and ultimately to the Tujunga Wash Channel, west of Cold Water Canyon Ave.
- The soccer field east of Ethel Ave. is made of synthetic turf and contains an underground storm drain collection system.

The existing storm drain system shall be evaluated in the Los Angeles Valley College Storm Water Master Plan proposed by Psomas to be completed as a separate document under a separate contract. Figure 10a, Existing Utility Map – Storm Drain, included herein illustrates the existing storm drain utility mapping completed as part of the campus utility mapping effort described in the Executive Summary of this report. Existing storm drain mapping information can also be found in the 24"x36" Composite Utility Base Maps provided in Appendix A.

*(Page Intentionally Left Blank)*



- LEGEND:**
-  EXISTING BUILDING
  -  21" OR LARGER EXISTING STORM DRAIN LINE
  -  18" EXISTING STORM DRAIN LINE
  -  15" EXISTING STORM DRAIN LINE
  -  12" EXISTING STORM DRAIN LINE
  -  10" EXISTING STORM DRAIN LINE
  -  8" EXISTING STORM DRAIN LINE
  -  6" OR SMALLER EXISTING STORM DRAIN LINE
  -  EXISTING STORM DRAIN LINE (SIZE UNKNOW)

- NOTE:**
1. REFER TO TABLES ES-1 AND ES-2 FOR BUILDING NAMES.
  2. THE INFORMATION SHOWN HEREON IS A GRAPHICAL DEPICTION OF THE EXISTING CAMPUS UTILITY SYSTEMS. THE SITE SURVEY AND INFRASTRUCTURE STUDIES EXISTING UTILITY PLANS PREPARED UNDER SEPARATE COVER SHALL BE REFERENCED FOR DETAILED INFORMATION



FIGURE 2a  
 EXISTING UTILITY MAP - STORM DRAIN

*(Page Intentionally Left Blank)*

**SECTION 3 – WATER SYSTEM**

**3.1 SYSTEM DESCRIPTION**

The existing water distribution system serving the campus buildings operates as two separate systems; domestic and fire water. The campus has a separate system that supplies water for landscape irrigation and is discussed in Section 4 – Irrigation Water System.

The Los Angeles Department of Water and Power (LADWP) provides domestic and fire water service at twenty-two locations along Fulton Avenue, Oxnard Street, Ethel Avenue, and Burbank Boulevard. Information on the locations and sizes of each water meter, and the maximum and minimum pressure information at the existing water connections were obtained from LADWP. A copy of this data is provided in Appendix C of this report. Although Ethel Avenue is part of the campus, the underground water mains are owned and operated by LADWP.

Although the campus is generally served by separate domestic and fire water LADWP meters, there is one combined domestic and fire water service which enters the campus from Burbank Boulevard, approximately 600 feet east of the centerline of Fulton Avenue. The service originates off a 16-inch public main in Burbank Boulevard. After passing through a 6-inch meter and double check backflow preventor, the water is conveyed north to the campus distribution network via a 6-inch steel pipe. At the southwest corner of the Life Science building, the 6-inch combined domestic and fire water line separates into a 6-inch domestic water line and a 6-inch fire water line that provide service for a majority of the campus buildings. The overall campus domestic and fire water distribution network consists mostly of steel and polyvinyl chloride (PVC) pipe.

The domestic water is controlled by two pressure regulators in the Central Power Plant and distributed north through the east and west utility tunnels via 4-inch, 5-inch, and 6-inch steel pipes. A 4-inch domestic water main provides a connection between the utility tunnels at the north end, and a 2-inch domestic water main provides a connection between the utility tunnels at the south end, thus providing the campus with a looped domestic water system.

At the fire water separation point there is a check valve assembly which controls backflow of fire water to the domestic water system. Fire water is then distributed north to existing buildings, not through the utility tunnel. This system is considered the main campus distribution network.

Water service for the buildings that are not connected to the main campus distribution network, including fire hydrants, the existing bungalows located at the southern part of campus, and the athletic complex east of Ethel Avenue is provided through independent connections to the LADWP public water mains within Fulton Avenue, Oxnard Street, Ethel Avenue, and Burbank Boulevard.

The existing water system and locations of each DWP connection are illustrated on Figure 3a, Existing Utility Map – Water Distribution.

**3.2 METHODOLOGY**

Existing domestic water demands for the campus were estimated based on an analysis of existing LADWP meter readings over a recent four-year period. Results of this analysis are summarized in the following table.

Table 3-1: Historical Domestic Water Use

Historical Domestic Water Use (2006-2009)							
POC No.	Meter No.	Size	In Session Demand				
			Avg Day (gpd)	Avg Day (gpd)	Avg Day (gpm)	Max Day (gpm)	Pk Hour (gpm)
DW-1	N/A <sup>1</sup>	4"	1,182	7,450	5	16	31
DW-2	31613248	2"	2,629	16,562	12	35	69
DW-3	90158297	3"	1,092	6,880	5	14	29
DW-4	90158338	3"	213	1,344	1	3	6
DW-5	96101603 <sup>2</sup>	4"	1,732	10,913	8	23	45
DW-6	96101001	4"	3,335	21,008	15	44	88
DW-7	43081918	1"	0	0	0	0	0
DW-8	90158324	3"	0	0	0	0	0
DW-9	90151287	3"	1,718	10,825	8	23	45
DW-10	90010468	6"	30,215	190,354	132	397	793
FW-1	41471	8"	0	0	0	0	0
FW-2	5032955	6"	0	0	0	0	0
FW-3	40274	6"	0	0	0	0	0
FW-4	40859	6"	0	0	0	0	0
FW-5	40845	6"	0	0	0	0	0
FW-6	40846	6"	0	0	0	0	0
FW-7	244	6"	0	0	0	0	0
FW-8	N/A <sup>1</sup>	6"	0	0	0	0	0
FW-9	40588	6"	0	0	0	0	0
FW-10	844	6"	0	0	0	0	0

FW-11	244	6"	0	0	0	0	0
Total =			42,117	265,338	184	553	1,106

DW = Domestic Water

FW = Fire Water

<sup>1</sup> Meter has not been installed because building project is currently under construction.

<sup>2</sup> Meter number changed from 2653275 in March of 2008.

LADWP meter readings for Point of Connection (POC) No. DW-7 and DW-8 indicated that there was no domestic water usage associated with those specific water meters during the four-year period from 2006 to 2009. The LADWP meter readings also indicated that there was no fire water usage due to the fact that the campus did not have any significant fires during the four-year period.

To account for the fact that the majority of the domestic water system demand occurs during the periods when school is in session, the average annual demand was assumed to be generated over eight months of the year, five days a week and eight hours a day to get the average in-session flow rates. As seen from the table above, this calculation results in an in-session, campus-wide average daily flow rate of 184 gpm. A maximum day factor of 3.0 times average day and a peak hour factor of 6.0 times average day result in flow rates of 553 gpm and 1,106 gpm for in session maximum day and peak hour demands, respectively. Methods of estimating water flows and modeling water usage are based on common engineering principles.

The location of each domestic and fire water POC is illustrated on Figure 3a, Existing Utility Map – Water Distribution.

In addition to daily usage demands, the fire water systems must meet the City of Los Angeles Fire Department (LAFD) fire access and fire flow requirements. The fire water systems shall meet the following criteria for design and construction:

- Fire hydrants shall be spaced at a maximum of 300 feet along fire lanes. Buildings shall be within 300 feet of a fire hydrant approved by LAFD.
- Water system shall have a minimum fire flow of 6,000 gpm from four fire hydrants flowing simultaneously.
- Water system shall have a minimum residual water pressure of 20 psi with the required 6,000 gpm flowing.

**3.3 ANALYSIS OF EXISTING SYSTEM**

A computer model of the existing water network was created with H20Net Version 8.0 to represent the existing conditions on campus. The maximum daily flow demands for the campus, as calculated in Table 3-1, were applied to various nodes of the water model based on the square footage of the existing buildings. A fire flow demand of 1500 gpm was applied to four nodes in order to simulate the fire flow criteria set forth by the LAFD. This model was then run to test the existing system's ability to satisfy LAFD's fire flow criteria in conjunction with maximum daily flow demands disbursed throughout the campus. Table 3-2 summarizes the

results of the computer model for the existing water system. Figure 3c, Existing Water Distribution – Pipe and Node Map corresponds to the existing system model provided in Table 3-2.

### 3.4 ANALYSIS OF FUTURE NEEDS

The water system was evaluated with the addition of proposed buildings listed in Table ES-2 of the Executive Summary. Based on the future development presented in the Prop. J Master Plan as discussed in the Executive Summary, recommendations have been made to construct new water pipes, relocate and demolish various existing water lines in order to accommodate the future development. This is conceptually illustrated in Figure 3b, Future Conditions Utility Map – Water Distribution.

A second computer model was created to represent the future conditions on campus. Maximum daily flow demands for the existing and proposed buildings were applied to respective nodes of the water model based on the square footage of the buildings. Table 3-3 summarizes the results of the computer model for the proposed water system. Figure 3d, Proposed Water Distribution – Pipe and Node Map corresponds to the proposed system model provided in Table 3-3.

### 3.5 FINDINGS AND RECOMMENDATIONS

#### Findings

An evaluation of the existing water system revealed that the existing water system adequately supports the demand for existing buildings with no significant pipe losses due to pipe size or elevation. In addition, the existing water pressures throughout the campus satisfy LAFD's minimum requirement of 20 psi as shown under the "Pressure" column of Table 3-2.

As shown under the "Pressure" column of Table 3-3, results from the second computer model (proposed conditions) indicate that the existing water system can also adequately support the demand for the proposed buildings, as shown in the Prop. J Master Plan.

The results of both computer models also indicated that the combined domestic and fire water main connected to DW-10 exceeds the recommended maximum velocity of 10 feet per second for water mains.

#### Recommendations

Recommendations include providing new services to proposed buildings, re-routing water lines that are in conflict with proposed buildings, and removing old AC water pipes that currently serve buildings to be demolished as depicted in the Prop. J Master Plan. The recommendations have been categorized into three priority levels. Descriptions of each priority level are provided in the executive summary of this report.

It is recommended that future buildings are provided domestic and fire water service from the existing campus water distribution system rather

than providing a new separate LADWP connection for each building. It is also recommended that ductile iron (DI) pipe is used for new water mains and services. Ductile iron pipe has been proven to be stronger, more durable than PVC piping, and direct tapping to ductile iron is easier and less expensive than tapping into PVC piping.

As illustrated in Figure 3b, Future Conditions Utility Map – Water Distribution, the following are recommendations for improvements to the existing water system:

#### Priority 1

- Install new 4-inch DI domestic water pipe from the north end of the west utility tunnel and provide domestic water connections to serve the future Media Arts Center and Performance Arts Center (Buildings V-11 and V-15).
- Provide domestic water connection for the future Administration (Building V-12) from the existing 6-inch domestic water main in the west utility tunnel.
- Install new 6-inch fire water pipe extension from the existing 10-inch fire water main west of the Foreign Language building to serve the future Administration (Building V-12).
- Provide connection from the existing 6-inch combined domestic and fire water main to serve the future Planetarium Expansion (Building V-51). Since the connection is downstream from the domestic and fire water split, the building design team shall provide backflow preventors and check valves per AWWA guidelines.
- Provide domestic water connections for the future Multi-Purpose PE/Community Services Center and Athletic Training Facility (Buildings V-16 and V-13) from the existing 3-inch domestic water main south of Hatteras Street.
- Install new 6-inch DI fire water pipe from the existing 8" fire water main on the east side of the pool and provide connections to serve the future Multi-Purpose PE/Community Services Center Athletic Training Facility (Buildings V-16 and V-13).
- Relocate existing 6-inch fire water line in conflict with future Student Union (Building V-22). Provide fire water connections for the future Student Union and Parking Structure (Buildings V-22 and V-18).
- Install new 4-inch DI domestic water pipe from the existing 3-inch domestic water main located in the southwest corner of the campus and provide a domestic water connection to serve the future Baseball Field House (Building V-14).
- Although it is not recommended to install a new LADWP fire water connection for each proposed building, a new fire water connection off the 16-inch LADWP water main in Burbank Boulevard shall be installed to serve the future Baseball Field House (Building V-14)

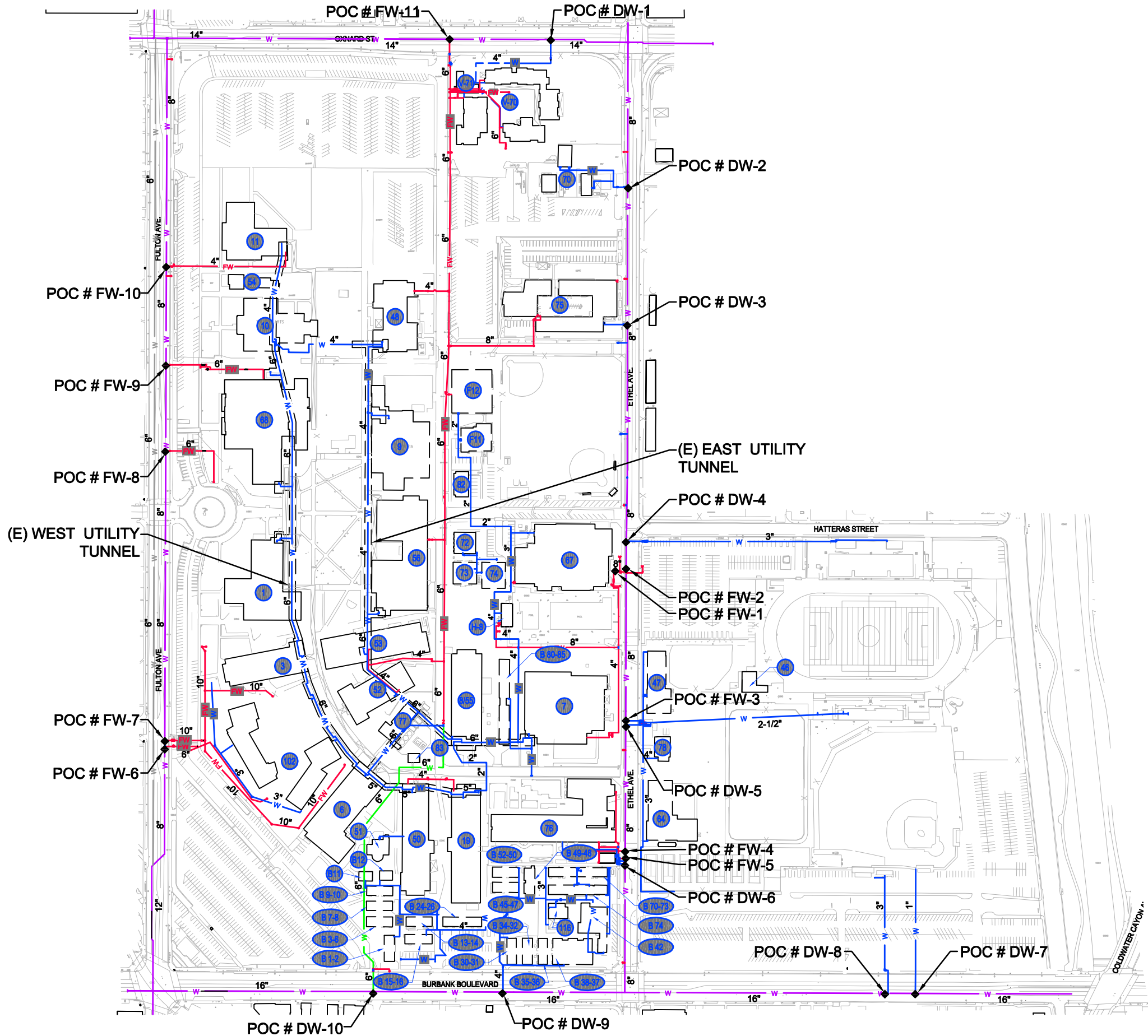
since there is no existing fire water serving the athletic fields east of Ethel Avenue.

- In order to provide a clear site for future development, either remove or slurry fill and abandon-in-place existing AC pipe laterals serving the existing bungalows and buildings 9, 48, 70, 72, 73, 74, 82, and F-12, which are planned to be demolished.
- Abandon LADWP water meters 31613248 (DW-2), 96101603 (DW-5), 43081918 (DW-7) and 90151287 (DW-9) once sites are demolished and water services are either removed or abandoned.
- Install new fire hydrants within 300 feet of proposed buildings per LAFD requirements.
- Further evaluate water mains shown to have a velocity larger than 10 feet per second to determine potential replacement, pipe upsizing or meter upsizing.

Based upon discussions with the campus facilities department, the following are recommendations for improving the existing water system:

#### Priority 2

- The 6-inch combined domestic and fire water main coming from the LADWP connection at Burbank Boulevard is old and corroding. It is recommended that the steel line be removed and replaced with new DI pipe as part of the Planetarium Expansion project.
- Install new LADWP connection at Fulton Avenue at the north end of campus to provide redundancy for the campus' domestic water system. A pressure regulator shall be installed to maintain adequate pressure.
- Coordinate with LADWP to determine if existing water meters need to be upsized, specifically at the combined domestic and fire water connection at Burbank Boulevard (DW-10) due to its large velocity shown in the attached model results.



**LEGEND:**

- EXISTING BUILDING
- EXISTING FIRE WATER
- EXISTING DOMESTIC WATER
- EXISTING COMBINED DOMESTIC & FIRE WATER
- EXISTING LADWP WATER MAIN
- EXISTING ABANDONED DWP WATER MAIN
- EXISTING DWP POINT OF CONNECTION (POC)








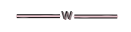





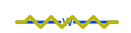

- NOTE:**
1. REFER TO TABLES ES-1 AND ES-2 FOR BUILDING NAMES.
  2. THE INFORMATION SHOWN HEREON IS A GRAPHICAL DEPICTION OF THE EXISTING CAMPUS UTILITY SYSTEMS. THE SITE SURVEY AND INFRASTRUCTURE STUDIES EXISTING UTILITY PLANS PREPARED UNDER SEPARATE COVER SHALL BE REFERENCED FOR DETAILED INFORMATION



FIGURE 3a  
 EXISTING UTILITY MAP - WATER DISTRIBUTION

*(Page Intentionally Left Blank)*

**LEGEND:**

-  EXISTING BUILDING
-  EXISTING FIRE WATER
-  EXISTING DOMESTIC WATER
-  EXISTING COMBINED DOMESTIC & FIRE WATER
-  EXISTING LADWP WATER MAIN
-  EXISTING ABANDONED DWP WATER MAIN
-  PROPOSED BUILDING
-  PROPOSED DOMESTIC WATER LINE
-  PROPOSED FIRE WATER LINE
-  PROPOSED DWP CONNECTION
-  PROPOSED DOMESTIC WATER P.O.C. FOR FUTURE BUILDING
-  PROPOSED FIRE WATER P.O.C. FOR FUTURE BUILDING
-  PROPOSED COMBINED DOMESTIC AND FIRE WATER P.O.C. FOR FUTURE BUILDING
-  EXISTING WATER LINE TO BE REMOVED
-  EXISTING WATER LINE TO BE EITHER REMOVED OR SLURRY FILLED AND ABANDONED IN PLACE

**NOTE:**

1. REFER TO TABLES ES-1 AND ES-2 FOR BUILDING NAMES.
2. THE INFORMATION SHOWN HEREON IS A GRAPHICAL DEPICTION OF THE EXISTING CAMPUS UTILITY SYSTEMS. THE SITE SURVEY AND INFRASTRUCTURE STUDIES EXISTING UTILITY PLANS PREPARED UNDER SEPARATE COVER SHALL BE REFERENCED FOR DETAILED INFORMATION
3. FUTURE CONDITIONS UTILITY MAPS SHOW ONLY THE DISPOSITION OF FUTURE BUILDINGS. REFER TO FIGURE 0e-MEASURE J MASTER PLAN SUMMARY FOR COMPLETE LAYOUT OF FUTURE CONDITIONS.

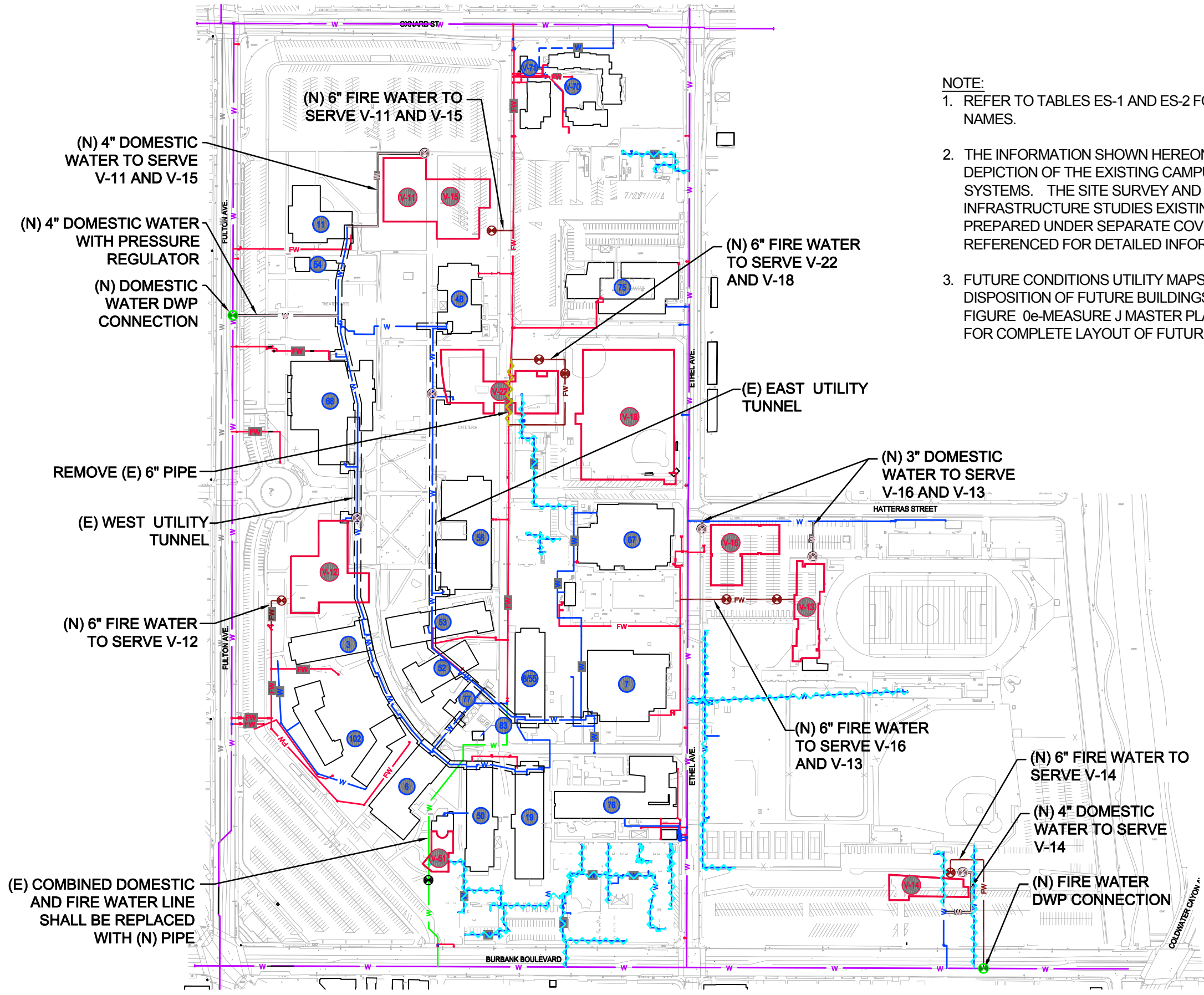


FIGURE 3b  
 FUTURE CONDITIONS UTILITY MAP - WATER DISTRIBUTION

*(Page Intentionally Left Blank)*

Table 3-2: Existing Water Distribution Model Output Results

Existing System Junction Output				
ID	Demand (gpm)	Elevation (ft)	Head (ft)	Pressure (psi)
J10	0	671.5	930	112
J12	0	671.2	930	112
J14	0	671	941	117
J16	0	664.5	936	118
J18	0	664	936	118
J20	0	665.5	936	117
J22	0	665.5	936	117
J24	0	667	928	113
J26	0	667	926	112
J28	0	668	922	110
J30	0	668	929	113
J32	0	668.8	929	113
J34	0	669	930	113
J36	0	670	931	113
J38	0	670.3	931	113
J40	0	671	933	114
J42	0	672	938	115
J44	0	672.4	934	113
J46	0	675	923	108
J48	0	675.7	923	107
J50	0	676.4	924	107
J52	0	687.3	924	103
J54	0	686.4	925	104
J56	0	683	935	109
J58	0	683	934	109
J60	0	681	928	107
J62	0	680	927	107
J64	0	676	923	107
J66	0	676	923	107
J68	0	674	929	110
J70	0	674	929	110

Existing System Pipe Output								
ID	From Node	To Node	Length (ft)	Diameter (in)	Flow (gpm)	Velocity (ft/s)	Headloss (ft)	HL/1000 (ft/kft)
P11	J10	J12	614	16	-970.11	1.55	0.36	0.59
P13	J12	J14	362	16	-8143.49	12.99	10.97	30.35
P15	J14	J16	340	16	5505.80	8.79	4.99	14.70
P17	J16	J18	82	8	134.12	0.86	0.04	0.44
P19	J18	J20	284	8	134.12	0.86	0.13	0.44
P21	J20	J22	28	8	46.12	0.29	0.00	0.06
P23	J22	J24	281	8	1273.48	8.13	8.03	28.58
P25	J24	J26	71	8	1273.48	8.13	2.02	28.58
P27	J26	J28	424	8	715.06	4.56	4.16	9.82
P29	J28	J30	88	8	-2284.94	14.58	7.46	84.39
P31	J30	J32	100	8	-429.62	2.74	0.38	3.82
P33	J32	J34	199	8	-429.62	2.74	0.76	3.82
P35	J34	J36	254	8	-429.62	2.74	0.97	3.82
P37	J36	J38	51	8	-429.62	2.74	0.19	3.82
P39	J38	J40	127	8	-945.55	6.04	2.10	16.47
P41	J40	J42	255	8	-945.55	6.04	4.21	16.47
P43	J42	J44	99	8	1426.01	9.10	3.48	35.24
P45	J44	J46	305	8	1426.01	9.10	10.77	35.24
P47	J46	J48	218	14	1426.01	2.97	0.50	2.31
P49	J48	J50	282	14	-1458.05	3.04	0.68	2.40
P51	J50	J52	788	14	-941.23	1.96	0.84	1.07
P53	J52	J54	58	8	-941.23	6.01	0.95	16.33
P55	J54	J56	577	8	-941.23	6.01	9.42	16.33
P57	J56	J58	27	8	1159.27	7.40	0.65	24.02
P59	J58	J60	248	8	1159.27	7.40	5.96	24.02
P61	J60	J62	240	8	450.58	2.88	1.00	4.17
P63	J62	J64	807	8	493.93	3.15	3.99	4.95
P65	J64	J66	17	8	-970.11	6.19	0.29	17.27
P67	J66	J68	300	8	-970.11	6.19	5.18	17.27
P69	J68	J70	50	12	-970.11	2.75	0.12	2.40
P71	J70	J10	347	12	-970.11	2.75	0.83	2.40

Table 3-2: Existing Water Distribution Model Output Results (Continued)

Existing System Junction Output				
ID	Demand (gpm)	Elevation (ft)	Head (ft)	Pressure (psi)
J72	1500	671.5	897	98
J74	0	671.8	889	94
J76	0	677	842	71
J78	30	675	821	63
J80	0	675	815	61
J82	1500	671.5	799	55
J84	0	672	800	55
J86	0	672	810	60
J88	0	672	832	69
J94	0	672	858	80
J96	0	672.8	866	84
J98	0	674	876	88
J100	0	675	902	99
J102	0	676	914	103
J104	0	676	919	105
J106	31	675.7	922	107
J108	0	675.7	914	103
J110	69	674.5	912	103
J112	29	675	866	83
J114	26	675	810	59
J116	8	675	795	52
J118	32	676	794	51
J120	0	677	793	50
J122	0	678	792	49
J124	75	679	791	49
J126	0	680	791	48
J128	36	681	790	47
J130	124	681	790	47
J132	0	683	790	46
J134	29	684	790	46
J136	6	684	789	46

Existing System Pipe Output								
ID	From Node	To Node	Length (ft)	Diameter (in)	Flow (gpm)	Velocity (ft/s)	Headloss (ft)	HL/1000 (ft/kft)
P73	J12	J72	63	6	2881.31	32.69	32.92	526.48
P75	J72	J74	57	6	1381.31	15.67	7.62	134.91
P77	J74	J76	353	6	1381.31	15.67	47.63	134.91
P79	J76	J78	156	6	1381.31	15.67	20.99	134.91
P81	J78	J80	42	6	1351.71	15.34	5.44	129.61
P83	J80	J82	123	6	1351.71	15.34	15.94	129.60
P85	J82	J84	117	6	-148.29	1.68	0.25	2.16
P87	J84	J86	179	6	-892.59	10.13	10.77	60.09
P89	J86	J88	339	6	-918.49	10.42	21.49	63.36
P97	J94	J96	136	6	-918.49	10.42	8.60	63.36
P99	J96	J98	153	6	-947.49	10.75	10.24	67.12
P101	J98	J100	387	6	-947.49	10.75	25.95	67.12
P103	J100	J102	172	6	-947.49	10.75	11.52	67.12
P105	J102	J104	78	6	-947.49	10.75	5.27	67.12
P107	J104	J50	66	6	-947.49	10.75	4.42	67.12
P109	J48	J106	489	4	31.00	0.79	0.42	0.86
P111	J102	J108	257	6	0.00	0.00	0.00	0.00
P113	J42	J110	236	2	69.00	7.05	26.09	110.62
P115	J96	J112	310	8	29.00	0.19	0.01	0.03
P117	J86	J114	261	4	25.90	0.66	0.16	0.62
P119	J84	J116	103	6	744.30	8.45	4.40	42.92
P121	J116	J118	170	6	325.84	3.70	1.58	9.30
P123	J118	J120	127	6	270.09	3.06	0.84	6.57
P125	J120	J122	132	6	270.09	3.06	0.87	6.57
P127	J122	J124	121	6	270.09	3.06	0.80	6.57
P129	J124	J126	108	6	194.99	2.21	0.39	3.59
P131	J126	J128	225	6	194.99	2.21	0.81	3.59
P133	J128	J130	145	6	159.09	1.81	0.36	2.46
P135	J130	J132	178	6	35.19	0.40	0.03	0.15
P137	J132	J134	232	6	35.19	0.40	0.03	0.15
P139	J134	J136	122	4	28.20	0.72	0.09	0.72

Table 3-2: Existing Water Distribution Model Output Results (Continued)

Existing System Junction Output				
ID	Demand (gpm)	Elevation (ft)	Head (ft)	Pressure (psi)
J138	22	685	789	45
J140	0	685	935	108
J142	0	680.5	927	107
J144	0	676	794	51
J146	0	675	794	51
J148	0	673	794	52
J152	0	677	923	107
J154	0	677.5	923	106
J156	0	678	923	106
J158	0	677.5	923	106
J160	0	677	923	107
J162	0	674	795	52
J164	18	676	794	51
J166	0	675	794	51
J168	0	675	794	51
J170	111	675	793	51
J172	39	675	790	50
J176	28	673	794	52
J178	0	670	794	54
J180	0	670.5	792	53
J182	0	672	791	52
J184	2	672	791	51
J186	0	672	790	51
J188	0	672	790	51
J190	0	672	789	51
J192	15	671	786	50
J194	51	671	785	49
J196	1500	669	917	107
J198	0	668	909	104
J200	1500	672	894	96
J202	0	668	922	110

Existing System Pipe Output								
ID	From Node	To Node	Length (ft)	Diameter (in)	Flow (gpm)	Velocity (ft/s)	Headloss (ft)	HL/1000 (ft/kft)
P141	J136	J138	155	4	21.90	0.56	0.07	0.45
P143	J56	J140	372	4	0.00	0.00	0.00	0.00
P145	J62	J142	219	6	0.00	0.00	0.00	0.00
P147	J118	J144	64	5	23.55	0.38	0.01	0.17
P149	J144	J146	75	5	23.55	0.38	0.01	0.17
P151	J146	J148	40.58	5	23.55	0.38	0.01	0.17
P155	J64	J152	112.23	10	0	0	0	0
P157	J152	J154	138.71	10	0	0	0	0
P159	J154	J156	192.44	10	0	0	0	0
P161	J154	J158	124.03	10	0	0	0	0
P163	J152	J160	597.33	10	0	0	0	0
P165	J116	J162	49.68	6	410.86	4.66	0.71	14.28
P167	J162	J164	78.67	6	216.01	2.45	0.34	4.34
P169	J164	J166	105.43	6	197.71	2.24	0.39	3.69
P171	J166	J168	55.27	6	197.71	2.24	0.2	3.69
P173	J168	J170	99.1	6	197.71	2.24	0.37	3.69
P175	J170	J172	561.7	4	86.31	2.2	3.21	5.72
P179	J162	J176	112.95	6	194.85	2.21	0.41	3.59
P183	J178	J180	287.89	4	93.7	2.39	1.92	6.66
P185	J180	J182	67.52	4	93.7	2.39	0.45	6.66
P187	J182	J184	72.02	4	93.7	2.39	0.48	6.66
P189	J184	J186	59.28	4	92	2.35	0.38	6.44
P191	J186	J188	46	4	92	2.35	0.3	6.44
P193	J188	J190	25.96	3	92	4.18	0.68	26.15
P195	J190	J192	138.44	3	92	4.18	3.62	26.15
P197	J192	J194	64.85	3	50.6	2.3	0.56	8.64
P199	J28	J196	35.24	8	3,000.00	19.15	4.92	139.72
P201	J196	J198	207.95	8	1,500.00	9.57	8.05	38.71
P203	J198	J200	387.4	8	1,500.00	9.57	14.99	38.71
P205	J28	J202	62.39	8	0.00	0	0	0
P207	J198	J204	324.94	6	0.00	0	0	0

Table 3-2: Existing Water Distribution Model Output Results (Continued)

Existing System Junction Output				
ID	Demand (gpm)	Elevation (ft)	Head (ft)	Pressure (psi)
J204	0	670	909	103
J206	6	666	929	114
J208	4	667	925	112
J210	14	667	925	112
J212	0	666	925	112
J214	27	665	924	112
J216	88	668	934	115
J218	0	668	936	116
J220	0	668	936	116
J222	0	668	936	116
J224	60	670	794	54
J226	0	670	794	54
J228	0	670.5	791	52
J230	7	671	785	49
J232	0	669	794	54
J234	0	672	941	116
J236	2	672	941	116
J238	0	671	941	117
J240	0	674	941	116
J242	2	674	941	116
J244	0	674.5	941	115
J246	4	675	941	115
J248	2	674	940	115
J250	0	673	941	116
J252	2	668	941	118
J254	0	667	941	119
J256	9	666	941	119
J258	0	665	941	119
J260	8	665	940	119
J262	1	666	940	119
J264	0	667	941	119

Existing System Pipe Output								
ID	From Node	To Node	Length (ft)	Diameter (in)	Flow (gpm)	Velocity (ft/s)	Headloss (ft)	HL/1000 (ft/kft)
P209	J30	J206	726.56	3	6.00	0.27	0.12	0.17
P211	J26	J208	48.84	3	45.00	2.04	0.34	6.96
P213	J208	J210	203.65	3	14.10	0.64	0.17	0.81
P215	J208	J212	578.65	2.5	0.00	0	0	0
P217	J208	J214	563.05	3	26.9	1.22	1.51	2.68
P219	J20	J216	228.23	4	88	2.25	1.35	5.93
P221	J22	J218	26.77	6	0	0	0	0
P223	J218	J220	162.31	6	0	0	0	0
P225	J218	J222	100.33	6	0	0	0	0
P227	J178	J224	49.66	6	67.1	0.76	0.02	0.5
P229	J224	J226	29.15	2	6.8	0.69	0.04	1.51
P231	J226	J228	59.62	1	6.8	2.78	2.64	44.3
P233	J228	J230	138.45	1	6.8	2.78	6.13	44.3
P235	J226	J232	76.08	2	0	0	0	0
P237	J14	J234	75.8	4	38.2	0.98	0.1	1.26
P239	J234	J236	107.38	4	29.9	0.76	0.09	0.8
P241	J236	J238	21.01	4	25.7	0.66	0.01	0.6
P243	J238	J240	202.65	4	8.4	0.21	0.02	0.08
P245	J240	J242	44.69	1.5	2.1	0.38	0.03	0.7
P247	J240	J244	146.12	4	6.3	0.16	0.01	0.04
P249	J244	J246	176.99	3	4.1	0.19	0.01	0.08
P251	J244	J248	78.68	1	2.2	0.9	0.43	5.48
P253	J240	J250	182.79	2	0	0	0	0
P257	J236	J252	211.7	4	2.2	0.06	0	0.01
P259	J238	J254	176.31	4	17.3	0.44	0.05	0.29
P261	J254	J256	131.56	3	16.5	0.75	0.14	1.08
P263	J256	J258	147.31	3	7.5	0.34	0.04	0.25
P265	J258	J260	44.69	3	7.5	0.34	0.01	0.25
P267	J254	J262	69.5	0.75	0.8	0.58	0.24	3.42
P269	J254	J264	88.96	3	0	0	0	0
P271	J234	J266	171.47	4	8.3	0.21	0.01	0.07

Table 3-2: Existing Water Distribution Model Output Results (Continued)

Existing System Junction Output				
ID	Demand (gpm)	Elevation (ft)	Head (ft)	Pressure (psi)
J266	8	669	941	118
J268	26	672	777	46
J270	0	660	926	115
J272	0	662	926	114
J274	25	677.5	790	49
J276	0	673	794	52
J278	30	672	794	53

Existing System Pipe Output								
ID	From Node	To Node	Length (ft)	Diameter (in)	Flow (gpm)	Velocity (ft/s)	Headloss (ft)	HL/1000 (ft/kft)
P273	RES9000	J56	73.34	30	2,100.50	0.95	0.01	0.11
P275	RES9002	J60	90.61	30	-708.69	0.32	0	0.02
P277	RES9004	J62	87.9	30	43.35	0.02	0	0
P279	RES9006	J64	102.64	30	-1,464.03	0.66	0.01	0.06
P281	RES9008	J12	72.56	30	-4,292.07	1.95	0.03	0.43
P283	RES9010	J14	92.72	30	13,687.49	6.21	0.34	3.72
P285	RES9012	J22	78.93	30	1,227.36	0.56	0	0.04
P287	RES9014	J26	110.94	30	-513.42	0.23	0	0.01
P289	RES9016	J30	74.18	30	1,861.32	0.84	0.01	0.09
P291	RES9018	J38	97.8	30	-515.93	0.23	0	0.01
P293	RES9020	J42	107.47	30	2,440.57	1.11	0.02	0.15
P295	RES9022	J48	79.73	30	-2,853.07	1.29	0.02	0.2
P297	RES9024	J50	91.43	30	1,464.31	0.66	0.01	0.06
P299	J192	J268	479.46	2	26.00	2.66	8.7	18.15
P301	J88	J94	405.05	6	-918.49	10.42	25.67	63.36
P303	J16	J270	727.16	16	5,371.68	8.57	10.21	14.04
P305	J270	J272	312.72	3	0.00	0	0	0
P307	J270	RES9026	103.79	30	5,371.68	2.44	0.07	0.66
P309	J134	J274	267.69	4	-21.91	0.56	0.12	0.45
P311	J274	J172	189.96	4	-47.21	1.21	0.36	1.87
P313	J176	J276	46.84	6	167.35	1.9	0.13	2.71
P315	J276	J178	157.67	6	160.8	1.82	0.4	2.51
P317	J276	J278	277.9	2	6.55	0.67	0.39	1.41
P319	J278	J148	108.85	5	-23.55	0.38	0.02	0.17

*(Page Intentionally Left Blank)*

Table 3-3: Proposed Water Distribution Model Output Results

Proposed System Junction Output				
ID	Demand (gpm)	Elevation (ft)	Head (ft)	Pressure (psi)
J10	0	671.5	930	112
J12	0	671.2	930	112
J14	0	671	941	117
J16	0	664.5	936	118
J18	0	664	936	118
J20	0	665.5	936	117
J22	0	665.5	936	117
J24	0	667	928	113
J26	0	667	926	112
J28	0	668	922	110
J30	0	668	929	113
J32	0	668.8	929	113
J34	0	669	930	113
J36	0	670	931	113
J38	0	670.3	931	113
J40	0	671	933	114
J42	0	672	938	115
J44	0	672.4	934	113
J46	0	675	923	108
J48	0	675.7	923	107
J50	0	676.4	924	107
J52	0	687.3	924	103
J54	0	686.4	925	104
J56	0	683	935	109
J58	0	683	934	109
J60	0	681	928	107
J62	0	680	927	107
J64	0	676	923	107
J66	0	676	923	107
J68	0	674	929	110
J70	0	674	929	110

Proposed System Pipe Output								
ID	From Node	To Node	Length (ft)	Diameter (in)	Flow (gpm)	Velocity (ft/s)	Headloss (ft)	HL/1000 (ft/kft)
P11	J10	J12	614	16	-970.48	1.55	0.36	0.59
P13	J12	J14	362	16	-8142.30	12.99	10.97	30.34
P15	J14	J16	340	16	5506.42	8.79	5.00	14.70
P17	J16	J18	82	8	134.45	0.86	0.04	0.44
P19	J18	J20	284	8	134.45	0.86	0.13	0.44
P21	J20	J22	28	8	46.45	0.30	0.00	0.06
P23	J22	J24	281	8	1273.47	8.13	8.03	28.58
P25	J24	J26	71	8	1273.47	8.13	2.02	28.58
P27	J26	J28	424	8	715.09	4.56	4.16	9.82
P29	J28	J30	88	8	-2284.91	14.58	7.46	84.39
P31	J30	J32	100	8	-429.66	2.74	0.38	3.82
P33	J32	J34	199	8	-429.66	2.74	0.76	3.82
P35	J34	J36	254	8	-429.66	2.74	0.97	3.82
P37	J36	J38	51	8	-429.66	2.74	0.19	3.82
P39	J38	J40	127	8	-945.62	6.04	2.10	16.47
P41	J40	J42	255	8	-945.62	6.04	4.21	16.47
P43	J42	J44	99	8	1426.06	9.10	3.48	35.25
P45	J44	J46	305	8	1426.06	9.10	10.77	35.25
P47	J46	J48	218	14	1426.06	2.97	0.50	2.31
P49	J48	J50	282	14	-1459.68	3.04	0.68	2.41
P51	J50	J52	788	14	-941.15	1.96	0.84	1.07
P53	J52	J54	58	8	-941.15	6.01	0.95	16.33
P55	J54	J56	577	8	-941.15	6.01	9.42	16.33
P57	J56	J58	27	8	1223.50	7.81	0.72	26.54
P61	J60	J62	240	8	450.40	2.87	1.00	4.17
P63	J62	J64	807	8	493.93	3.15	3.99	4.95
P65	J64	J66	17	8	-970.48	6.19	0.29	17.28
P67	J66	J68	300	8	-970.48	6.19	5.18	17.28
P69	J68	J70	50	12	-970.48	2.75	0.12	2.40
P71	J70	J10	347	12	-970.48	2.75	0.83	2.40
P73	J12	J72	63	6	2539.76	28.82	26.06	416.77

Table 3-3: Proposed Water Distribution Model Output Results (Continued)

Proposed System Junction Output				
ID	Demand (gpm)	Elevation (ft)	Head (ft)	Pressure (psi)
J72	1500	671.5	904	101
J74	0	671.8	899	99
J76	0	677	871	84
J78	30	675	859	80
J80	0	675	856	78
J82	1500	671.5	847	76
J84	0	672	849	77
J86	0	672	856	80
J88	0	672	868	85
J94	0	672	884	92
J96	0	672.8	889	94
J98	0	674	895	96
J100	0	675	911	102
J102	0	676	918	105
J104	0	676	921	106
J106	31	675.7	922	107
J108	0	675.7	918	105
J112	29	675	889	93
J114	26	675	855	78
J116	8	675	849	75
J118	32	676	849	75
J120	0	677	849	75
J122	0	678	849	74
J124	75	679	849	74
J126	0	680	850	74
J128	86	681	850	73
J130	124	681	851	74
J132	0	683	854	74
J134	0	684	857	75
J136	6	684	855	74
J138	22	685	854	73

Proposed System Pipe Output								
ID	From Node	To Node	Length (ft)	Diameter (in)	Flow (gpm)	Velocity (ft/s)	Headloss (ft)	HL/1000 (ft/kft)
P75	J72	J74	57	6	1039.76	11.80	4.50	79.72
P79	J76	J78	156	6	1032.56	11.72	12.25	78.70
P81	J78	J80	42	6	1002.96	11.38	3.13	74.58
P83	J80	J82	123	6	1002.96	11.38	9.17	74.58
P85	J82	J84	117	6	-497.04	5.64	2.37	20.32
P87	J84	J86	179	6	-668.50	7.59	6.30	35.18
P89	J86	J88	339	6	-694.40	7.88	12.80	37.75
P97	J94	J96	136	6	-694.40	7.88	5.12	37.75
P99	J96	J98	153	6	-723.40	8.21	6.21	40.72
P101	J98	J100	387	6	-723.40	8.21	15.74	40.72
P103	J100	J102	172	6	-723.40	8.21	6.99	40.72
P105	J102	J104	78	6	-723.40	8.21	3.20	40.72
P107	J104	J50	66	6	-723.40	8.21	2.68	40.72
P109	J48	J106	489	4	31.00	0.79	0.42	0.86
P111	J102	J108	257	6	0.00	0.00	0.00	0.00
P115	J96	J112	310	8	29.00	0.19	0.01	0.03
P117	J86	J114	261	4	25.90	0.66	0.16	0.62
P119	J84	J116	103	6	171.46	1.95	0.29	2.83
P121	J116	J118	170	6	-35.93	0.41	0.03	0.16
P123	J118	J120	127	6	-104.46	1.19	0.14	1.13
P125	J120	J122	132	6	-104.46	1.19	0.15	1.13
P127	J122	J124	121	6	-104.46	1.19	0.14	1.13
P129	J124	J126	108	6	-179.56	2.04	0.33	3.08
P131	J126	J128	225	6	-179.56	2.04	0.69	3.08
P133	J128	J130	145	6	-265.76	3.02	0.92	6.37
P135	J130	J132	178	6	-389.66	4.42	2.30	12.95
P137	J132	J134	232	6	-389.66	4.42	3.00	12.95
P139	J134	J136	122	4	118.90	3.04	1.26	10.36
P141	J136	J138	155	4	112.60	2.87	1.46	9.36
P143	J56	J140	372	4	0.00	0.00	0.00	0.00
P145	J62	J142	219	6	0.00	0.00	0.00	0.00

Table 3-3: Proposed Water Distribution Model Output Results (Continued)

Proposed System Junction Output				
ID	Demand (gpm)	Elevation (ft)	Head (ft)	Pressure (psi)
J140	0	685	935	108
J142	0	680.5	927	107
J144	0	676	849	75
J146	0	675	849	75
J148	0	673	849	76
J152	0	677	923	107
J154	0	677.5	923	106
J156	0	678	923	106
J158	0	677.5	923	106
J160	0	677	923	107
J162	0	674	849	76
J164	18	676	849	75
J166	0	675	849	75
J168	0	675	849	75
J170	111	675	849	75
J172	58	675	850	76
J176	28	673	849	76
J178	0	670	848	77
J180	0	670.5	848	77
J182	0	672	847	76
J184	2	672	847	76
J186	0	672	847	76
J188	0	672	847	76
J190	0	672	847	76
J192	0	671	846	76
J194	51	671	845	75
J196	1500	669	917	107
J198	0	668	909	104
J200	1500	672	894	96
J202	0	668	922	110
J204	0	670	909	103

Proposed System Pipe Output								
ID	From Node	To Node	Length (ft)	Diameter (in)	Flow (gpm)	Velocity (ft/s)	Headloss (ft)	HL/1000 (ft/kft)
P147	J118	J144	64	5	36.34	0.59	0.02	0.39
P149	J144	J146	75	5	36.34	0.59	0.03	0.39
P151	J146	J148	41	5	36.34	0.59	0.02	0.39
P155	J64	J152	112	10	0.00	0.00	0.00	0.00
P157	J152	J154	139	10	0.00	0.00	0.00	0.00
P159	J154	J156	192.44	10	0	0	0	0
P161	J154	J158	124.03	10	0	0	0	0
P163	J152	J160	597.33	10	0	0	0	0
P165	J116	J162	49.68	6	199.78	2.27	0.19	3.76
P167	J162	J164	78.67	6	65.92	0.75	0.04	0.48
P169	J164	J166	105.43	6	47.62	0.54	0.03	0.26
P171	J166	J168	55.27	6	47.62	0.54	0.01	0.26
P173	J168	J170	99.1	6	47.62	0.54	0.03	0.26
P175	J170	J172	561.7	4	-63.78	1.63	1.84	3.27
P179	J162	J176	112.95	6	133.87	1.52	0.2	1.79
P183	J178	J180	287.89	4	52.3	1.34	0.65	2.26
P185	J180	J182	67.52	4	52.3	1.34	0.15	2.26
P187	J182	J184	72.02	4	52.3	1.34	0.16	2.26
P189	J184	J186	59.28	4	50.6	1.29	0.13	2.13
P191	J186	J188	46	4	50.6	1.29	0.1	2.13
P193	J188	J190	25.96	3	50.6	2.3	0.22	8.64
P195	J190	J192	138.44	3	50.6	2.3	1.2	8.64
P197	J192	J194	64.85	3	50.6	2.3	0.56	8.64
P199	J28	J196	35.24	8	3,000.00	19.15	4.92	139.73
P201	J196	J198	207.95	8	1,500.00	9.57	8.05	38.71
P203	J198	J200	387.4	8	1,500.00	9.57	14.99	38.7
P205	J28	J202	62.39	8	0.00	0	0	0
P207	J198	J204	324.94	6	0.00	0	0	0
P219	J20	J216	228.23	4	88.00	2.25	1.35	5.93
P221	J22	J218	26.77	6	0.00	0	0	0
P223	J218	J220	162.31	6	0.00	0	0	0

Table 3-3: Proposed Water Distribution Model Output Results (Continued)

Proposed System Junction Output				
ID	Demand (gpm)	Elevation (ft)	Head (ft)	Pressure (psi)
J206	6	666	928	113
J216	88	668	934	115
J218	0	668	936	116
J220	0	668	936	116
J222	0	668	936	116
J224	60	670	848	77
J226	0	670	848	77
J232	0	669	848	78
J270	0	660	926	115
J272	11	662	926	114
J274	25	677.5	853	76
J276	0	673	849	76
J278	30	672	849	77
J282	0	682	929	107
J284	7	675	884	91
J286	0	668	929	113
J288	0	667	928	113
J290	33	668	928	113
J292	20	667	928	113
J298	91	679	851	75

Proposed System Pipe Output								
ID	From Node	To Node	Length (ft)	Diameter (in)	Flow (gpm)	Velocity (ft/s)	Headloss (ft)	HL/1000 (ft/kft)
P225	J218	J222	100.33	6	0.00	0	0	0
P227	J178	J224	49.66	6	60.30	0.68	0.02	0.41
P229	J224	J226	29.15	2	0.00	0	0	0
P235	J226	J232	76.08	2	0.00	0	0	0
P273	RES9000	J56	73.34	30	2,164.64	0.98	0.01	0.12
P275	RES9002	J60	90.61	30	-469.85	0.21	0	0.01
P277	RES9004	J62	87.9	30	43.53	0.02	0	0
P279	RES9006	J64	102.64	30	-1,464.40	0.66	0.01	0.06
P281	RES9008	J12	72.56	30	-4,632.07	2.1	0.04	0.5
P283	RES9010	J14	92.72	30	13,648.72	6.19	0.34	3.7
P285	RES9012	J22	78.93	30	1,227.02	0.56	0	0.04
P287	RES9014	J26	110.94	30	-558.38	0.25	0	0.01
P289	RES9016	J30	74.18	30	1,913.25	0.87	0.01	0.1
P291	RES9018	J38	97.8	30	-515.97	0.23	0	0.01
P293	RES9020	J42	107.47	30	2,371.68	1.08	0.02	0.14
P295	RES9022	J48	79.73	30	-2,854.74	1.3	0.02	0.2
P297	RES9024	J50	91.43	30	1,241.93	0.56	0	0.04
P301	J88	J94	405.05	6	-694.40	7.88	15.29	37.75
P303	J16	J270	727.16	16	5,371.96	8.57	10.21	14.05
P305	J270	J272	312.72	3	10.80	0.49	0.15	0.49
P307	J270	RES9026	103.79	30	5,361.16	2.43	0.07	0.65
P309	J134	J274	267.69	4	147.08	3.76	4.11	15.36
P311	J274	J172	189.96	4	121.78	3.11	2.06	10.83
P313	J176	J276	46.84	6	106.37	1.21	0.05	1.17
P315	J276	J178	157.67	6	112.60	1.28	0.2	1.3
P317	J276	J278	277.9	2	-6.24	0.64	0.36	1.29
P319	J278	J148	108.85	5	-36.34	0.59	0.04	0.39
P323	J58	J282	184.33	8	1,223.50	7.81	4.89	26.54
P325	J282	J60	63.79	8	920.25	5.87	1	15.66
P333	J74	J284	187.66	6	1,039.76	11.8	14.96	79.72
P335	J284	J76	165.46	6	1,032.56	11.72	13.02	78.7

Table 3-3: Proposed Water Distribution Model Output Results (Continued)

Proposed System Pipe Output								
ID	From Node	To Node	Length (ft)	Diameter (in)	Flow (gpm)	Velocity (ft/s)	Headloss (ft)	HL/1000 (ft/kft)
P337	J30	J286	45.16	3	58.00	2.63	0.5	11.13
P339	J286	J288	315.93	3	25.50	1.16	0.77	2.43
P341	J288	J206	365.47	3	6.00	0.27	0.06	0.17
P343	J286	J290	32.78	3	32.5	1.48	0.12	3.81
P345	J288	J292	102.8	3	19.5	0.89	0.15	1.48
P353	J138	J298	424.79	4	90.7	2.32	2.66	6.27
P355	J134	J282	296.5	4	-655.64	16.74	72.52	244.59
P357	J282	RES9032	90.61	30	-352.39	0.16	0	0

*(Page Intentionally Left Blank)*



*(Page Intentionally Left Blank)*



*(Page Intentionally Left Blank)*

**SECTION 4 – IRRIGATION WATER SYSTEM**

**4.1 SYSTEM DESCRIPTION**

The campus has a dedicated system for the distribution of water for landscape irrigation. Water for domestic consumption and for fire fighting is included in a separate distribution system and is discussed in Section 3 – Water System.

The Los Angeles Department of Water and Power (LADWP) provides water to the campus irrigation system at six locations. Information on the locations and sizes of each water meter, and the maximum and minimum pressure information at the existing irrigation water connections were obtained from LADWP. A copy of this data is provided in Appendix C of this report.

The following is a summary description of the existing campus irrigation water system:

1. The first existing service (IRR-1) enters the campus from Fulton Avenue, approximately 700 feet north of Burbank Boulevard. The 4-inch service originates off an 8-inch main in Fulton Avenue. The minimum static pressure at this service is 115 psi. After passing through a meter and backflow preventor, irrigation water is distributed via steel piping.
2. The second existing service (IRR-2) enters the campus from Fulton Avenue, approximately 400 feet south of Oxnard Street. The 3-inch service originates off an 8-inch main in Fulton Avenue. The minimum static pressure at this service is 115 psi. After passing through a meter and backflow preventor, irrigation water is distributed via steel piping.
3. The third existing service (IRR-3) is currently under construction. The 2-inch service is intended to originate off a 14-inch main in Oxnard Street and enter the campus from Oxnard Street, approximately 234 feet east of Ethel Avenue. The minimum static pressure at this service is 107 psi. This line will serve the Child Development and Family Complex building via polyvinyl chloride (PVC) piping once construction is completed, and is not interconnected with any of the other existing services on campus.
4. The fourth existing service (IRR-4) enters the campus from Ethel Avenue, approximately 1140 feet north of Burbank Boulevard. The 3-inch service originates off an 8-inch main in Ethel Avenue. The minimum static pressure at this service is 117 psi. After passing through a meter and backflow preventor, irrigation water is distributed via asbestos concrete (AC) piping.
5. The fifth existing service (IRR-5) enters the campus from Ethel Avenue, approximately 340 feet north of Burbank Boulevard. The 1.5-inch service originates off an 8-inch main in Ethel Avenue. The minimum static pressure at this service is 117 psi. As-built drawings of the campus provided by the college do not show any irrigation water lines connected to this service.

6. The sixth existing service (IRR-6) enters the campus from Burbank Boulevard, approximately 645 feet east of Ethel Avenue. The 2-inch service originates off a 16-inch main in Burbank Boulevard. The minimum static pressure at this service is 115 psi. After passing through a meter and backflow preventor, irrigation water is distributed via AC piping.
7. The seventh existing service (IRR-7) enters the campus from Ethel Avenue, approximately 730 feet north of Burbank Boulevard. The 3-inch service originates off an 8-inch main in Ethel Avenue. The minimum static pressure at this service is 117 psi. After passing through a meter and backflow preventor, irrigation water is distributed via PVC piping.

The existing irrigation water distribution system and locations of the DWP connections are shown on Figure 4a, Existing Utility Map – Irrigation Water Distribution.

**4.2 METHODOLOGY**

Existing irrigation water demands for the campus were estimated based on an analysis of existing LADWP water meter readings over a recent four-year period. Results of this analysis are summarized in the following table.

Table 4-1: Historical Irrigation Water Use

Historical Irrigation Water Use (2006-2009)						
POC No.	Meter No.	Size	Avg Day (gpd)	Pk Months	8 Hour Irrigation	
				Avg Day (gpd)	Avg Use (gpm)	Pk Use (gpm)
IRR-1	96101531 <sup>1</sup>	4"	26,957	45,824	95	191
IRR-2	90119288	3"	25,105	46,422	97	193
IRR-3	N/A <sup>2</sup>	2"	3,141	5,566	12	23
IRR-4	90158426	3"	16,738	30,790	64	128
IRR-5	90141903	1.5"	0	0	0	0
IRR-6	90158323	2"	5,263	9,326	19	39
IRR-7	90158319	3"	0	0	0	0
Total =			77,204	137,928	287	575

<sup>1</sup> Meter number changed from 3409891 in March of 2008.

<sup>2</sup> Meter has not been installed as project is currently under construction.

LADWP meter readings for Point of Connection (POC) No. IRR-5 and IRR-7 indicated there was no irrigation water usage associated with those specific water meters.

The first average day column is the average annual amounts divided by 365 days. The peak month average day considers only the higher meter

readings for the dry months between June and November. To account for the fact that irrigation is typically performed between 10pm and 6am, seven days per week, the peak month amounts were divided by 480 to get the 8 Hour Irrigation Average Use. The last column labeled 8 Hour Irrigation Peak Use is twice the previous column to account for the maximum day during those summer months and the fact that the irrigation water system cannot be fine-tuned to completely average out the demands over an eight-hour period.

The location of each irrigation water Point of Connection (POC) is illustrated on Figure 3a, Existing Utility Map – Water Distribution.

**4.3 ANALYSIS OF EXISTING SYSTEM**

A computer model of the existing irrigation water network was created with H2ONet Version 8.0 to represent the existing conditions on campus. The calculated maximum daily flow demands for the campus, as calculated in Table 4-1, were applied to various nodes of the irrigation water model based on the square footage of existing landscape areas. Table 4-2 summarizes the results of the computer model for the existing irrigation water system. Figure 4c, Existing Irrigation Water Distribution – Pipe and Node Map corresponds to the existing system model provided in Table 4-2.

**4.4 ANALYSIS OF FUTURE NEEDS**

The irrigation water system was evaluated with the addition of proposed buildings listed in Table ES-2 of the Executive Summary. Based on the future development presented in the Prop. J Master Plan as discussed in the Executive Summary, recommendations have been made to relocate and demolish various existing irrigation water lines in order to accommodate the future development. This is conceptually illustrated in Figure 4b, Future Conditions Utility Map – Irrigation Water Distribution.

A second computer model was created to represent the future conditions on campus. Maximum daily flow demands were added at nodes associated with proposed landscape areas identified in the Prop. J Master Plan in order to account for the increased demand. Table 4-3 summarizes the results of the computer model for the proposed water system. Figure 4d, Proposed Irrigation Water Distribution – Pipe and Node Map corresponds to the proposed system model provided in Table 4-3.

As part of this study, reclaimed water was evaluated as a possible alternative for campus irrigation. The municipal reclaimed water source closest to the LAVC campus is the Donald C. Tillman Water Reclamation Plant operated by LADWP, which is located about 3.3 miles west of LAVC. At this time, reclaimed water service is not available to the campus since there are no reclaimed water pipelines that extend from the plant to the campus vicinity. It is recommended that the college install new irrigation lines using purple PVC piping in anticipation of a future reclaimed water system. Onsite water reclamation was not evaluated as part of this study.

#### 4.5 FINDINGS AND RECOMMENDATIONS

##### Findings

An evaluation of the existing irrigation water system revealed that the existing irrigation water system adequately supports the demand of existing buildings and landscape areas with no significant pipe losses due to pipe size or elevation. The existing irrigation water system can also adequately support the demand for proposed buildings and landscape areas as depicted in the Prop. J Master Plan.

##### Recommendations

Recommendations include providing new services to landscape areas proposed in the Prop. J Master Plan and re-routing irrigation water lines that are in conflict with proposed buildings. The recommendations have been categorized into three priority levels. Descriptions of each priority level are provided in the executive summary of this report.

It is recommended that the future landscape areas are provided irrigation water service from the existing campus distribution system rather than providing new DWP connections.

As illustrated in Figure 4b, Future Conditions Utility Map – Irrigation Water Distribution, the following are recommendations for improvements to the existing irrigation water system:

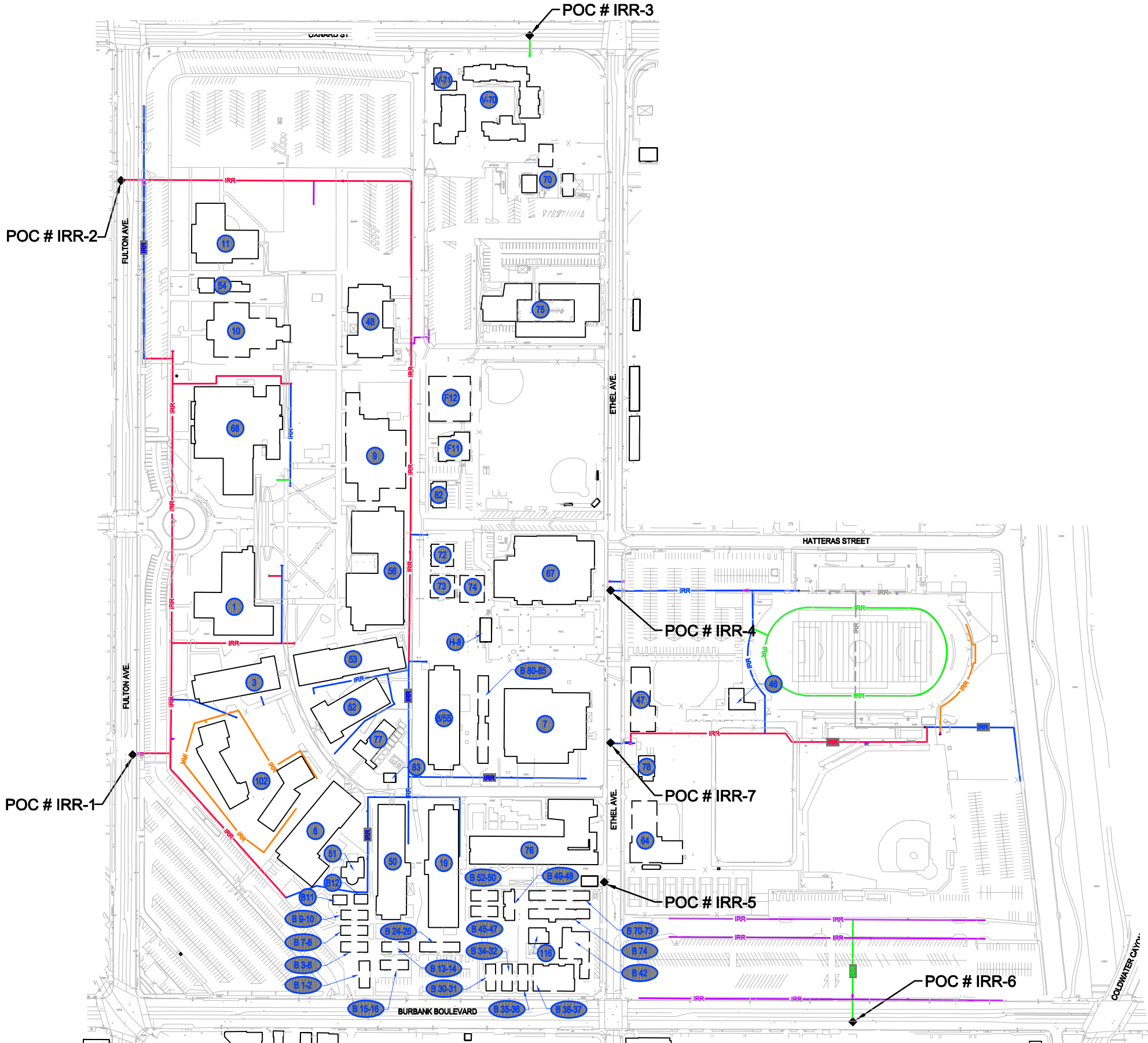
##### Priority 1

- Relocate 4-inch irrigation water line in conflict with future Media Arts Center and Performance Arts Center (Buildings V-11 and V-15).
- Relocate 4-inch irrigation water line in conflict with future Student Union (Building V-22).
- Relocate 4-inch irrigation water line in conflict with future Administration (Building V-12).
- Relocate 4-inch irrigation water line in conflict with future Planetarium Expansion (Building V-51).
- Relocate 3-inch irrigation water line in conflict with future Multi-Purpose PE/Community Services Center (Building V-16).
- Provide irrigation water service for the new athletic fields by connecting to the existing 3-inch irrigation water main currently serving the athletic fields. Install new irrigation water lines using purple PVC piping.

##### Priority 2

- Based on record information collected from the CPM, LADWP irrigation water meter 90141903 (IRR-5) is not providing service to the campus. The college should conduct further investigation on the LADWP meter to determine if the LADWP meter can be abandoned.

- The college should conduct further investigation on LADWP irrigation water meter 90158319 (IRR-7) to determine the reason for zero usage. The LADWP meter may be closed or not functioning properly.



**LEGEND:**

- EXISTING BUILDING
- 4" EXISTING IRRIGATION WATER LINE
- 3" EXISTING IRRIGATION WATER LINE
- 2" EXISTING IRRIGATION WATER LINE
- 2 1/2" OR SMALLER EXISTING IRRIGATION WATER LINE
- EXISTING IRRIGATION WATER LINE (SIZE UNKNOWN)
- EXISTING ABANDONED IRRIGATION WATER LINE
- EXISTING DWP POINT OF CONNECTION (POC)

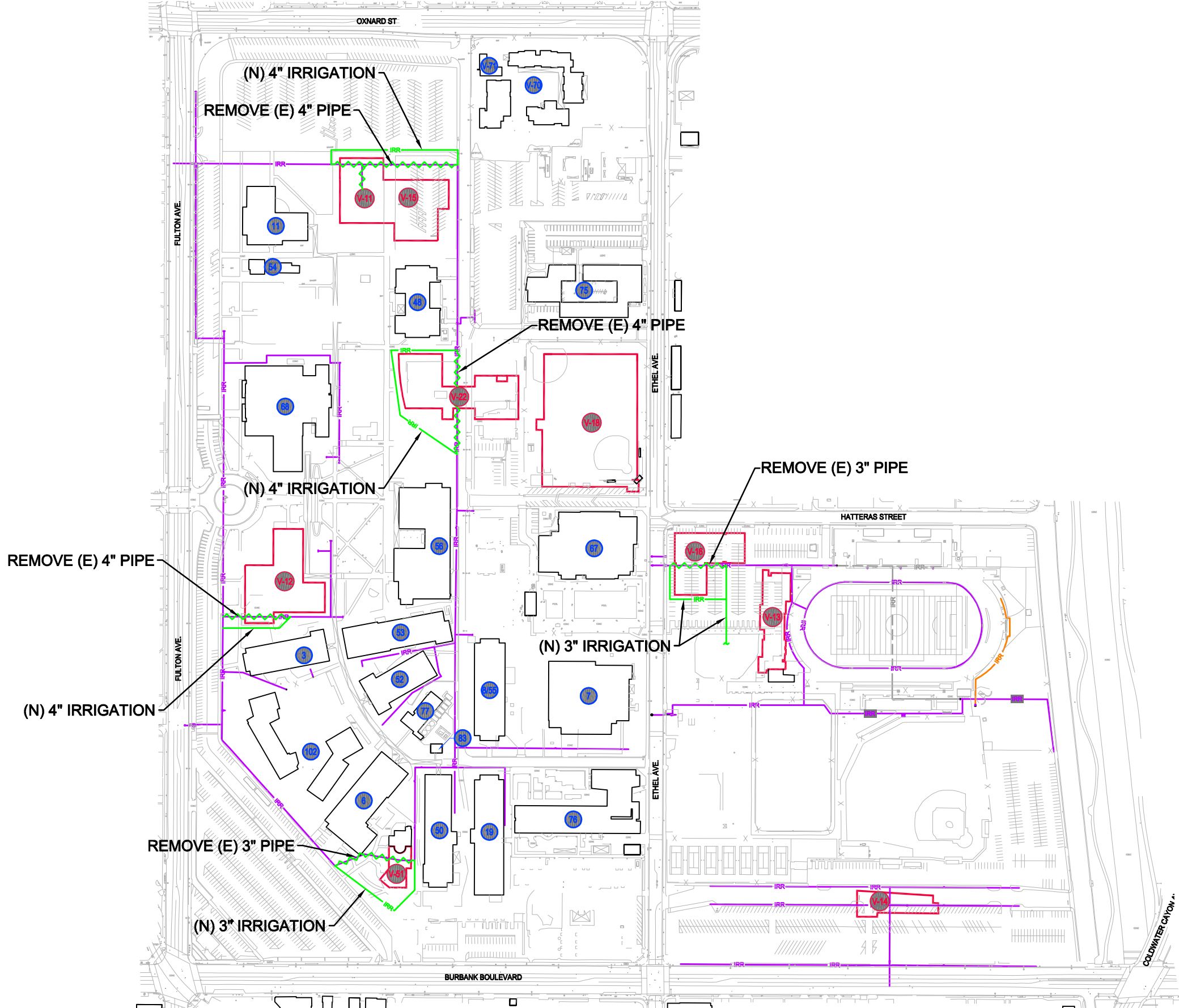
**NOTE:**

1. REFER TO TABLES ES-1 AND ES-2 FOR BUILDING NAMES.
2. THE INFORMATION SHOWN HEREON IS A GRAPHICAL DEPICTION OF THE EXISTING CAMPUS UTILITY SYSTEMS. THE SITE SURVEY AND INFRASTRUCTURE STUDIES EXISTING UTILITY PLANS PREPARED UNDER SEPARATE COVER SHALL BE REFERENCED FOR DETAILED INFORMATION



FIGURE 4a  
 EXISTING UTILITY MAP - IRRIGATION WATER DISTRIBUTION

*(Page Intentionally Left Blank)*



**LEGEND:**

- EXISTING BUILDING
- EXISTING IRRIGATION WATER LINE
- PROPOSED BUILDING
- EXISTING IRRIGATION WATER LINE TO BE REMOVED
- PROPOSED IRRIGATION WATER LINE
- EXISTING ABANDONED IRRIGATION WATER LINE

- NOTE:**
1. REFER TO TABLES ES-1 AND ES-2 FOR BUILDING NAMES.
  2. THE INFORMATION SHOWN HEREON IS A GRAPHICAL DEPICTION OF THE EXISTING CAMPUS UTILITY SYSTEMS. THE SITE SURVEY AND INFRASTRUCTURE STUDIES EXISTING UTILITY PLANS PREPARED UNDER SEPARATE COVER SHALL BE REFERENCED FOR DETAILED INFORMATION
  3. FUTURE CONDITIONS UTILITY MAPS SHOW ONLY THE DISPOSITION OF FUTURE BUILDINGS. REFER TO FIGURE 0e-MEASURE J MASTER PLAN SUMMARY FOR COMPLETE LAYOUT OF FUTURE CONDITIONS.



FIGURE 4b  
 PROPOSED UTILITY MAP - IRRIGATION WATER DISTRIBUTION

*(Page Intentionally Left Blank)*

Table 4-2: Existing Irrigation Water Distribution Model Output Results

Existing System Junction Output				
ID	Demand (gpm)	Elevation (ft)	Head (ft)	Pressure (psi)
J10	0	671.5	958	124
J12	0	665	960	128
J14	0	661	963	131
J16	0	660	960	130
J18	0	661	958	129
J20	0	662	957	128
J22	6.4	661	957	128
J24	6.4	664	957	127
J26	6.4	665	957	126
J28	6.4	661	957	128
J30	6.4	660	960	130
J32	6.4	664	960	128
J34	0	668	938	117
J42	0	663	935	118
J44	11.7	661	934	118
J52	0	668	938	117
J54	0	675	923	107
J56	0	675.5	923	107
J58	0	675.5	923	107
J60	23	675.7	923	107
J62	0	687.3	927	104
J64	0	684	950	115
J66	0	676	942	115
J68	0	674	954	121
J70	0	674.5	956	122
J72	0	676	942	115
J74	0	677	941	115
J76	0	677	941	115
J78	0	678	941	114
J80	0	682	944	113
J82	0	682	944	114

Existing System Pipe Output								
ID	From Node	To Node	Length (ft)	Diameter (in)	Flow (gpm)	Velocity (ft/s)	Headloss (ft)	HL/1000 (ft/kft)
P11	J10	J12	1316	16	-1493.05	2.38	1.73	1.31
P13	J12	J14	661	16	-2805.95	4.48	2.79	4.22
P15	J14	J16	58	2	38.40	3.92	2.16	37.36
P17	J16	J18	166	2	25.60	2.61	2.92	17.63
P19	J18	J20	50	2	12.80	1.31	0.24	4.88
P21	J20	J22	356	2	6.40	0.65	0.48	1.35
P23	J20	J24	495	2	6.40	0.65	0.67	1.35
P25	J18	J26	495	2	6.40	0.65	0.67	1.35
P27	J18	J28	356	2	6.40	0.65	0.48	1.35
P29	J16	J30	404	2	6.40	0.65	0.55	1.35
P31	J16	J32	576	2	6.40	0.65	0.78	1.35
P43	J42	J44	170	3	11.70	0.53	0.10	0.57
P51	J34	J52	24	8	730.63	4.66	0.25	10.21
P53	J52	J54	1467	8	730.63	4.66	14.98	10.21
P55	J54	J56	115	14	730.63	1.52	0.08	0.67
P57	J56	J58	10	14	730.63	1.52	0.01	0.67
P59	J58	J60	97	14	730.63	1.52	0.07	0.67
P61	J60	J62	1066	14	-1860.20	3.88	4.02	3.78
P63	J62	J64	394	8	-1860.20	11.87	22.72	57.66
P65	J64	J66	1549	8	504.42	3.22	7.97	5.14
P67	J66	J68	331	8	-1493.05	9.53	12.70	38.37
P69	J68	J70	50	8	-1493.05	9.53	1.90	38.37
P71	J70	J10	349	12	-1493.05	4.24	1.86	5.32
P73	J66	J72	29	4	45.88	1.17	0.05	1.77
P75	J72	J74	74	4	45.88	1.17	0.13	1.78
P77	J74	J76	145	4	18.38	0.47	0.05	0.33
P79	J76	J78	152	4	-9.12	0.23	0.01	0.09
P81	J78	J80	699	4	-64.12	1.64	2.31	3.30
P83	J80	J82	68	4	-91.62	2.34	0.43	6.39
P87	J82	J86	77	4	-91.62	2.34	0.49	6.39
P89	J86	J88	482	4	-91.62	2.34	3.08	6.39

Table 4-2: Existing Irrigation Water Distribution Model Output Results (Continued)

Existing System Junction Output				
ID	Demand (gpm)	Elevation (ft)	Head (ft)	Pressure (psi)
J86	0	681	945	114
J88	0	684	948	114
J90	27.5	686	948	113
J92	0	680	933	110
J94	27.5	681.4	933	109
J96	0	675	926	109
J98	27.5	673	915	105
J100	27.5	671	905	102
J102	27.5	673	901	99
J104	0	673	900	98
J106	0	673	897	97
J108	27.5	673	897	97
J110	27.5	668.5	896	98
J112	0	676	941	115
J114	0	674	941	116
J116	0	676	941	115
J118	0	676	941	115
J120	0	676	940	115
J122	0	675	940	115
J124	0	670	939	117
J126	27.5	669	939	117
J128	0	674	899	98
J130	27.5	677	899	96
J132	0	674	899	98
J134	0	675	899	97
J136	27.5	676.5	899	96
J138	0	678	941	114
J140	27.5	678	941	114
J142	0	681	941	113
J144	27.5	681	941	113
J146	27.5	678.5	940	113

Existing System Pipe Output								
ID	From Node	To Node	Length (ft)	Diameter (in)	Flow (gpm)	Velocity (ft/s)	Headloss (ft)	HL/1000 (ft/kft)
P91	J88	J90	198	4	27.50	0.70	0.14	0.69
P93	J64	J88	26	4	339.12	8.66	1.87	72.14
P95	J88	J92	458	4	220.00	5.62	14.84	32.37
P97	J92	J94	63	4	27.50	0.70	0.04	0.69
P99	J92	J96	264	4	192.50	4.91	6.67	25.28
P101	J96	J98	438	4	192.50	4.91	11.06	25.28
P103	J98	J100	516	4	165.00	4.21	9.80	19.00
P105	J100	J102	342	4	137.50	3.51	4.64	13.55
P107	J102	J104	23	3	110.00	4.99	0.83	36.41
P109	J104	J106	289	3	55.00	2.50	2.91	10.09
P111	J106	J108	180	3	27.50	1.25	0.50	2.79
P113	J74	J112	42	4	27.50	0.70	0.03	0.69
P115	J112	J114	467	4	27.50	0.70	0.32	0.69
P117	J114	J116	88	3	27.50	1.25	0.25	2.79
P119	J116	J118	101	3	27.50	1.25	0.28	2.79
P121	J118	J120	38	3	27.50	1.25	0.11	2.79
P123	J120	J122	256	3	27.50	1.25	0.72	2.79
P125	J122	J124	248	3	27.50	1.25	0.69	2.79
P127	J124	J126	159	3	27.50	1.25	0.44	2.79
P129	J104	J128	59	3	55.00	2.50	0.59	10.09
P131	J128	J130	204	3	27.50	1.25	0.57	2.79
P133	J128	J132	84	3	27.50	1.25	0.23	2.79
P135	J132	J134	92	3	27.50	1.25	0.26	2.79
P137	J134	J136	120	3	27.50	1.25	0.34	2.79
P139	J76	J138	56	3	27.50	1.25	0.16	2.79
P141	J138	J140	129	3	27.50	1.25	0.36	2.79
P143	J78	J142	297	4	55.00	1.40	0.74	2.48
P145	J142	J144	34	4	27.50	0.70	0.02	0.69
P147	J142	J146	182	3	27.50	1.25	0.51	2.79
P153	J80	J152	118	4	27.50	0.70	0.08	0.69
P155	J152	J154	20.82	4	27.5	0.7	0.01	0.69

Table 4-2: Existing Irrigation Water Distribution Model Output Results (Continued)

Existing System Junction Output				
ID	Demand (gpm)	Elevation (ft)	Head (ft)	Pressure (psi)
J152	0	683	944	113
J154	0	682.5	944	113
J162	27.5	680.5	943	114
J168	0	682.5	944	113
J170	0	667	937	117
J172	11.7	667	935	116
J174	0	666	934	116
J176	0	667	935	116
J178	11.7	667	935	116
J180	11.7	666.5	933	115
J182	11.7	666.5	930	114
J184	11.7	666.5	926	113
J186	11.7	666.5	926	112
J188	11.7	666.5	926	112
J190	11.7	667	928	113
J192	0	667	935	116
J194	11.7	666	935	116
J196	0	666	935	116
J198	0	666	935	116
J200	0	666	935	116
J202	11.7	666.5	934	116

Existing System Pipe Output								
ID	From Node	To Node	Length (ft)	Diameter (in)	Flow (gpm)	Velocity (ft/s)	Headloss (ft)	HL/1000 (ft/kft)
P169	J154	J168	201.06	4	27.5	0.7	0.14	0.69
P171	J168	J162	280.56	3	27.5	1.25	0.78	2.79
P173	J106	J110	478.82	3	27.5	1.25	1.34	2.79
P175	RES9000	J66	110.02	30	-1,951.59	0.89	0.01	0.1
P177	RES9002	J64	109.68	30	2,703.74	1.23	0.02	0.18
P179	RES9004	J60	104.5	30	-2,567.83	1.17	0.02	0.17
P181	RES9006	J34	100.92	30	1,116.99	0.51	0	0.04
P183	RES9008	J14	107.07	30	2,844.35	1.29	0.02	0.2
P185	J12	J170	746.19	8	1,312.90	8.38	22.57	30.24
P187	J170	J34	412.05	8	-334.68	2.14	0.99	2.41
P189	J170	RES9010	75.07	30	1,570.56	0.71	0.01	0.07
P191	J34	J172	387.07	3	51.68	2.35	3.48	8.99
P193	J172	J174	102.95	3	39.98	1.81	0.58	5.59
P195	J174	J176	192.49	3	-30.22	1.37	0.64	3.33
P197	J176	J178	101.93	3	-30.22	1.37	0.34	3.33
P199	J178	J170	449.38	4	-77.02	1.97	2.08	4.63
P201	J174	J180	44.54	2.5	70.2	4.59	1.72	38.52
P203	J180	J182	112.79	2	31.02	3.17	2.84	25.16
P205	J182	J184	333	2	19.32	1.97	3.49	10.47
P207	J184	J186	140.42	2	7.62	0.78	0.26	1.87
P209	J186	J188	154.06	2	-4.08	0.42	0.09	0.59
P211	J188	J190	323.22	2	-15.78	1.61	2.33	7.2
P213	J190	J180	207.31	2	-27.48	2.81	4.17	20.11
P215	J178	J192	84.14	4	35.1	0.9	0.09	1.08
P217	J192	J194	364.71	4	35.1	0.9	0.39	1.08
P219	J194	J196	40.15	4	23.4	0.6	0.02	0.51
P221	J196	J198	35.84	3	23.4	1.06	0.07	2.07
P223	J198	J200	54.59	2.5	11.7	0.76	0.08	1.39
P225	J200	J202	272.35	2.5	11.7	0.76	0.38	1.39
P227	J198	J42	197.88	3	11.7	0.53	0.11	0.57

*(Page Intentionally Left Blank)*

Table 4-3: Proposed Irrigation Water Distribution Model Output Results

Proposed System Junction Output				
ID	Demand (gpm)	Elevation (ft)	Head (ft)	Pressure (psi)
J10	0	671.5	958	124
J12	0	665	960	128
J14	0	661	963	131
J16	0	660	960	130
J18	0	661	958	129
J20	0	662	957	128
J22	6.4	661	957	128
J24	6.4	664	957	127
J26	6.4	665	957	126
J28	6.4	661	957	128
J30	6.4	660	960	130
J32	6.4	664	960	128
J34	0	668	938	117
J42	0	663	934	118
J44	11.7	661	934	118
J52	0	668	938	117
J54	0	675	923	107
J56	0	675.5	923	107
J58	0	675.5	923	107
J60	23	675.7	923	107
J62	0	687.3	927	104
J64	0	684	950	115
J66	0	676	942	115
J68	0	674	954	121
J70	0	674.5	956	122
J72	0	676	942	115
J74	0	677	941	115
J76	0	677	941	115
J78	0	678	941	114
J80	0	682	944	113
J82	0	682	944	114

Proposed System Pipe Output								
ID	From Node	To Node	Length (ft)	Diameter (in)	Flow (gpm)	Velocity (ft/s)	Headloss (ft)	HL/1000 (ft/kft)
P11	J10	J12	1316	16	-1493.05	2.38	1.73	1.31
P13	J12	J14	661	16	-2805.95	4.48	2.79	4.22
P15	J14	J16	58	2	38.40	3.92	2.16	37.36
P17	J16	J18	166	2	25.60	2.61	2.92	17.63
P19	J18	J20	50	2	12.80	1.31	0.24	4.88
P21	J20	J22	356	2	6.40	0.65	0.48	1.35
P23	J20	J24	495	2	6.40	0.65	0.67	1.35
P25	J18	J26	495	2	6.40	0.65	0.67	1.35
P27	J18	J28	356	2	6.40	0.65	0.48	1.35
P29	J16	J30	404	2	6.40	0.65	0.55	1.35
P31	J16	J32	576	2	6.40	0.65	0.78	1.35
P43	J42	J44	170	3	11.70	0.53	0.10	0.57
P51	J34	J52	24	8	730.62	4.66	0.25	10.21
P53	J52	J54	1467	8	730.62	4.66	14.98	10.21
P55	J54	J56	115	14	730.62	1.52	0.08	0.67
P57	J56	J58	10	14	730.62	1.52	0.01	0.67
P59	J58	J60	97	14	730.62	1.52	0.07	0.67
P61	J60	J62	1066	14	-1860.19	3.88	4.02	3.78
P63	J62	J64	394	8	-1860.19	11.87	22.72	57.66
P65	J64	J66	1549	8	504.41	3.22	7.97	5.14
P67	J66	J68	331	8	-1493.05	9.53	12.70	38.37
P69	J68	J70	50	8	-1493.05	9.53	1.90	38.37
P71	J70	J10	349	12	-1493.05	4.24	1.86	5.32
P73	J66	J72	29	4	46.78	1.19	0.05	1.84
P75	J72	J74	74	4	46.78	1.19	0.14	1.84
P77	J74	J76	145	4	19.28	0.49	0.05	0.36
P79	J76	J78	152	4	-8.22	0.21	0.01	0.07
P81	J78	J80	699	4	-63.22	1.61	2.25	3.21
P83	J80	J82	68	4	-90.72	2.32	0.43	6.27
P87	J82	J86	77	4	-90.72	2.32	0.49	6.28
P89	J86	J88	482	4	-90.72	2.32	3.02	6.27

Table 4-3: Proposed Irrigation Water Distribution Model Output Results (Continued)

Proposed System Junction Output				
ID	Demand (gpm)	Elevation (ft)	Head (ft)	Pressure (psi)
J86	0	681	945	114
J88	0	684	948	114
J90	27.5	686	947	113
J92	0	680	931	109
J94	27.5	681.4	931	108
J96	0	675	923	108
J98	27.5	673	910	103
J100	35	671	893	96
J102	35	673	888	93
J104	0	673	887	93
J106	0	673	884	91
J108	27.5	673	884	91
J110	27.5	668.5	883	93
J112	0	676	941	115
J114	0	674	941	116
J120	0	676	940	114
J122	0	675	939	115
J124	0	670	939	116
J126	27.5	669	938	117
J128	0	674	886	92
J130	27.5	677	886	91
J132	0	674	886	92
J134	0	675	886	91
J136	27.5	676.5	886	91
J138	0	678	941	114
J140	27.5	678	941	114
J142	0	681	941	113
J144	27.5	681	941	113
J146	27.5	678.5	940	113
J152	0	683	944	113
J154	0	682.5	944	113

Proposed System Pipe Output								
ID	From Node	To Node	Length (ft)	Diameter (in)	Flow (gpm)	Velocity (ft/s)	Headloss (ft)	HL/1000 (ft/kft)
P91	J88	J90	198	4	27.50	0.70	0.14	0.69
P93	J64	J88	26	4	353.22	9.02	2.01	77.79
P95	J88	J92	458	4	235.00	6.00	16.77	36.57
P97	J92	J94	63	4	27.50	0.70	0.04	0.69
P99	J92	J96	264	4	207.50	5.30	7.66	29.05
P101	J96	J98	438	4	207.50	5.30	12.71	29.05
P105	J100	J102	342	4	145.00	3.70	5.12	14.96
P107	J102	J104	23	3	110.00	4.99	0.83	36.41
P109	J104	J106	289	3	55.00	2.50	2.91	10.09
P111	J106	J108	180	3	27.50	1.25	0.50	2.79
P113	J74	J112	42	4	27.50	0.70	0.03	0.69
P115	J112	J114	467	4	27.50	0.70	0.32	0.69
P123	J120	J122	256	3	27.50	1.25	0.72	2.79
P125	J122	J124	248	3	27.50	1.25	0.69	2.79
P127	J124	J126	159	3	27.50	1.25	0.44	2.79
P129	J104	J128	59	3	55.00	2.50	0.59	10.09
P131	J128	J130	204	3	27.50	1.25	0.57	2.79
P133	J128	J132	84	3	27.50	1.25	0.23	2.79
P135	J132	J134	92	3	27.50	1.25	0.26	2.79
P137	J134	J136	120	3	27.50	1.25	0.34	2.79
P139	J76	J138	56	3	27.50	1.25	0.16	2.79
P141	J138	J140	129	3	27.50	1.25	0.36	2.79
P143	J78	J142	297	4	55.00	1.40	0.74	2.48
P145	J142	J144	34	4	27.50	0.70	0.02	0.69
P147	J142	J146	182	3	27.50	1.25	0.51	2.79
P153	J80	J152	118	4	27.50	0.70	0.08	0.69
P155	J152	J154	21	4	27.50	0.70	0.01	0.69
P169	J154	J168	201	4	27.50	0.70	0.14	0.69
P171	J168	J162	280.56	3	27.5	1.25	0.78	2.79
P173	J106	J110	478.82	3	27.5	1.25	1.34	2.79
P175	RES9000	J66	110.02	30	-1,950.68	0.89	0.01	0.1

Table 4-3: Proposed Irrigation Water Distribution Model Output Results (Continued)

Proposed System Junction Output				
ID	Demand (gpm)	Elevation (ft)	Head (ft)	Pressure (psi)
J162	27.5	680.5	943	114
J168	0	682.5	943	113
J170	0	667	937	117
J172	11.7	667	934	116
J174	0	666	934	116
J176	0	667	934	116
J178	11.7	667	935	116
J180	11.7	666.5	932	115
J182	11.7	666.5	929	114
J184	11.7	666.5	926	112
J186	11.7	666.5	925	112
J188	11.7	666.5	925	112
J190	11.7	667	928	113
J192	0	667	935	116
J194	11.7	666	934	116
J196	0	666	934	116
J198	0	666	934	116
J200	0	666	934	116
J202	11.7	666.5	934	116
J204	0	673	909	102
J206	0	676.5	905	99
J208	0	675	901	98
J210	0	672	896	97
J212	0	674	941	116
J214	0	675	940	115
J216	0	667	935	116
J218	21	666	935	117

Proposed System Pipe Output								
ID	From Node	To Node	Length (ft)	Diameter (in)	Flow (gpm)	Velocity (ft/s)	Headloss (ft)	HL/1000 (ft/kft)
P177	RES9002	J64	109.68	30	2,717.82	1.23	0.02	0.19
P179	RES9004	J60	104.5	30	-2,567.82	1.17	0.02	0.17
P181	RES9006	J34	100.92	30	1,132.19	0.51	0	0.04
P183	RES9008	J14	107.07	30	2,844.35	1.29	0.02	0.2
P185	J12	J170	746.19	8	1,312.90	8.38	22.57	30.24
P187	J170	J34	412.05	8	-334.67	2.14	0.99	2.41
P189	J170	RES9010	75.07	30	1,564.77	0.71	0.01	0.07
P193	J172	J174	102.95	3	34.19	1.55	0.43	4.18
P195	J174	J176	192.49	3	-36.01	1.63	0.89	4.6
P197	J176	J178	101.93	3	-36.01	1.63	0.47	4.6
P199	J178	J170	449.38	4	-82.81	2.11	2.38	5.3
P201	J174	J180	44.54	2.5	70.2	4.59	1.72	38.52
P203	J180	J182	112.79	2	31.02	3.17	2.84	25.16
P205	J182	J184	333	2	19.32	1.97	3.49	10.47
P207	J184	J186	140.42	2	7.62	0.78	0.26	1.87
P209	J186	J188	154.06	2	-4.08	0.42	0.09	0.59
P211	J188	J190	323.22	2	-15.78	1.61	2.33	7.2
P213	J190	J180	207.31	2	-27.48	2.81	4.17	20.11
P215	J178	J192	84.14	4	35.1	0.9	0.09	1.08
P217	J192	J194	364.71	4	35.1	0.9	0.39	1.08
P219	J194	J196	40.15	4	23.4	0.6	0.02	0.51
P221	J196	J198	35.84	3	23.4	1.06	0.07	2.07
P223	J198	J200	54.59	2.5	11.7	0.76	0.08	1.4
P225	J200	J202	272.35	2.5	11.7	0.76	0.38	1.39
P227	J198	J42	197.88	3	11.7	0.53	0.11	0.57
P229	J98	J204	73.6	4	180	4.6	1.64	22.32
P231	J204	J206	182.22	4	180	4.6	4.07	22.32
P233	J206	J208	180.94	4	180	4.6	4.04	22.32
P235	J208	J210	189.97	4	180	4.6	4.24	22.32
P237	J210	J100	155.59	4	180	4.6	3.47	22.32
P239	J114	J212	204.94	3	27.5	1.25	0.57	2.79

Table 4-3: Proposed Irrigation Water Distribution Model Output Results (Continued)

Proposed System Pipe Output								
ID	From Node	To Node	Length (ft)	Diameter (in)	Flow (gpm)	Velocity (ft/s)	Headloss (ft)	HL/1000 (ft/kft)
P241	J212	J214	79.8	3	27.5	1.25	0.22	2.79
P243	J214	J120	81.73	3	27.5	1.25	0.23	2.79
P245	J34	J216	206.7	3	66.89	3.04	3	14.49
P247	J216	J172	180.38	3	45.89	2.08	1.3	7.21
P249	J216	J218	174.37	3	21	0.95	0.3	1.7

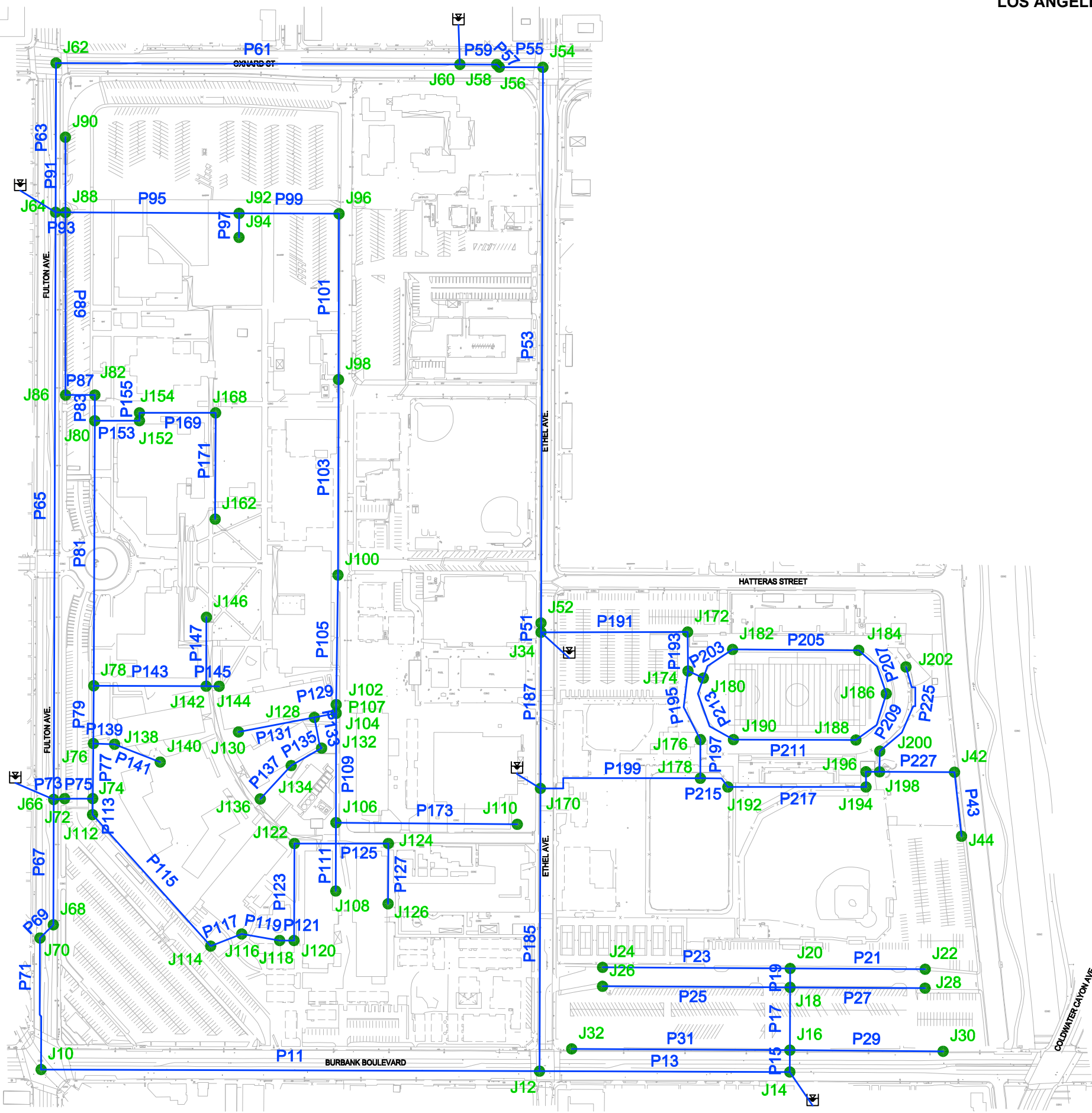
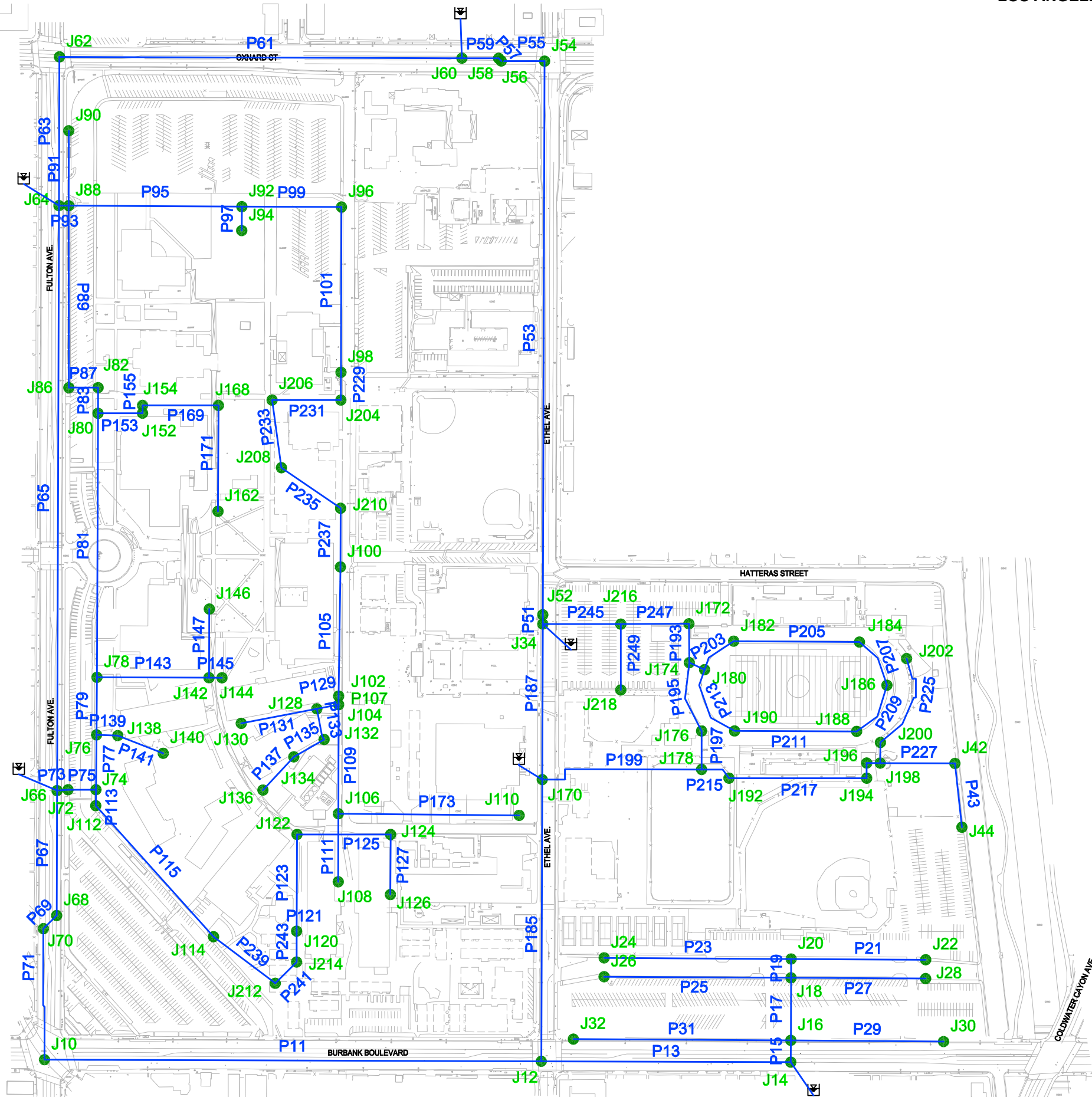


FIGURE 4c  
EXISTING IRRIGATION WATER DISTRIBUTION - PIPE AND NODE MAP

*(Page Intentionally Left Blank)*



**LEGEND:**

- IRRIGATION WATER PIPE
- IRRIGATION WATER NODE



FIGURE 4d  
 PROPOSED IRRIGATION WATER DISTRIBUTION - PIPE AND NODE MAP

*(Page Intentionally Left Blank)*

## SECTION 5 – ELECTRICAL SYSTEM

### 5.1 SYSTEM DESCRIPTION

Los Angeles Valley College was founded in 1949 and was located on the campus of Van Nuys High School.

Phase I of the Master Building Plan was completed in 1959. The following buildings were built Engineering, Foreign Language, Administration, and the Library. The Physics and Chemistry buildings have since been demolished and replaced by the new Student Service Center. In 1961, Phase II was completed, which included the Music, Theater Arts, Life Science Buildings and Cafeteria. Phase III was completed in 1963. This phase included the Business, Math-Science, Art and Planetarium buildings. Later in the 1970's phase IV was completed and included the Gymnasiums, Behavioral Science, Humanities, and the Campus Center buildings

Today, Valley College continues to meet the educational needs of the community serving more than 17,000 students with its 199 full time and 421 part time instructors.

The campus is served from a 4.160kV distribution system and derives its power from LADWP. An evaluation of the existing Electrical System revealed that the main switchgear is in new condition and was installed in 2008 and the distribution system in the tunnels has both new and ageing equipment. The campus has a medium voltage system that provides radial feeders to seven different sets of buildings offering no redundancy and limited isolation of buildings on campus. The campus is currently served from a single LADWP substation and there is no redundancy currently available from LADWP service.

The 4160 volt power is provided from a single service point where it is extended to a 5kV main switch and then metered at 4160 volts. The 4160V system then extends to campus owned transformers where it is transformed to low voltages to serve the various buildings throughout the campus. P2S evaluated the existing power distribution system currently serving the existing campus.

See Exhibit 5a for reference to the existing site electrical distribution system and Exhibit 5b for the existing campus single-line diagram.

#### Objective

The objective of this report is to evaluate the existing power distribution system and its adequacy to support new buildings, major renovations, and building retrofits that form part of the proposed campus Facilities Master Plan.

### 5.2 METHODOLOGY

The following methodology was adopted in formulating our electrical utility infrastructure master plan. The methodology presented below outlines the critical tasks that were performed in development of this master plan report.

- A critical aspect in the evaluation of the existing electrical system serving a facility is a detailed and accurate field investigation of the current system. Meetings and discussions with the campus helped gather existing information and any potential problems faced with the system. Existing conditions, together with potential problems, were discussed and identified. The existing system information was gathered through available record drawings and meetings with the campus facilities staff.
- A load flow study of the existing and future loads was developed and existing and proposed capacity requirements were developed. A watts/sqft of proposed facilities was assumed in our load studies. For all existing buildings, existing installed capacities of the substations/transformers were taken to estimate the total loads.
- The Electrical system was then evaluated for capacity, functionality, reliability, ease of maintenance, age, and its ability to serve the present and future needs of the campus.
- Alterations/upgrade/modifications necessary to support new buildings, major renovations, and building retrofits that form part of the proposed campus facilities master plan were identified.
- Recommendations were developed to support new buildings, major renovations, and building retrofits that form part of the proposed campus facilities master plan were identified.
- Costs associated with each of the required utility upgrades were developed and the most cost effective solution was recommended.

### 5.3 ANALYSIS OF EXISTING SYSTEM

Los Angeles Valley College campus is currently served from a 5kV, 1200A 3phase, 3wire switchgear that derives its service from a 5kV LA Department of Water and Power feeder. The LADWP transformer is located in the Power Plant yard and from there the power line comes in from an overhead 34.5kV transmission line. The switchgear comprises of seven 5 kV breakers and one extra space for a future circuit breaker. The main 5kV switchgear is provided with an LADWP meter section and a 1200 amp main circuit breaker. This main switchgear is located in a yard outside the Power Plant building on the south side of the campus. The service is metered at 5kV and distributes power through two underground tunnels that run the length of the campus to substations located below each building. The main switchgear and the main breakers are new and are in good condition.

The campus has seven LADWP meters that serve the campus. Four of them have been demolished or will be demolished. The main service to the campus is metered at 5kV and provides power to majority of the buildings on campus. Two separate LADWP meters serve the Bungalows located on the south side of the campus and will be demolished when the Bungalows are torn down. A third meter serves the old Child Care building located on the north side of the campus and is currently being torn down. The fourth and fifth meters serve the Gymnastics Center and the Field House and are scheduled for

demolition. The only other LADWP meter to remain serves the Stadium building. There are no sub meters currently to monitor energy usage at each of the buildings.

Power to each building on campus is served through two underground tunnels or utility corridors originating from the main switchgear. The 7 medium voltage feeders are routed in 4" rigid conduit and each serves 3, 4, or 5 sub-stations below the individual buildings. The feeders are routed to pull boxes or splice boxes in the tunnels and terminate in load interrupter switches that feed the sub stations. The some newer buildings have their sub-stations located above the tunnel at the building. The older buildings all have old sub-stations in the tunnels and built in the early sixties by Zinsco or Bulldog. These two manufacturers are both out of business and replacement parts are hard to find.

The existing electrical system has load interrupter switches which provide isolation of individual buildings and enable the facilities personnel to isolate a particular building for maintenance or expansion. However the radial feeders have multiple buildings on each circuit and if there is a fault, maintenance issue, or expansion to the circuit, multiple buildings will be shut down with no alternate power source. Therefore the current system offers limited isolation to the individual buildings.

Feeders A, B, C, D, E, F, and G originate from the main switchgear and are routed through duct banks and tunnels to serve each building on campus. Feeders A thru D are comprised of 3# 3/0kcmil. MV-105 133% EPR copper shielded cables, and are rated at 245A capacity and routed in 4"conduits. The total capacity of each feeder is approximately 5,100kW. Feeders E, F, and G are comprised of 3# 500kcmil. MV-105 133% EPR copper shielded cables and are rated at 450A capacity and routed in 4"conduits. The total capacity of each feeder is approximately 9,500kW.

Discussions with campus revealed that electrical service from LADWP at the stadium is more reliable than the main service at the central plant. The existing service at the stadium shall remain to provide more reliable power during events.

A review of the existing capacities revealed that the system is adequately sized to meet the demands of the current campus. The majority of the campus buildings emergency demand is met by emergency generators housed in close proximity to the building. The following is a brief description of each of the feeders and their routing to serve each building on campus.

Feeder 'A' currently serves 4 sub-stations in the west tunnel and serves the Foreign Language, Administration, Motion Picture Building Addition, Music Building and the Music Building chiller. The Art Theater Arts Building and the Physics A and B sub-stations have been disconnected.

Feeder 'B' serves Gymnasiums, the Life Science Building, the pool and the Allied Health Building.

Feeder 'C' serves 4 sub-stations in the east tunnel; the Behavior Science, Humanities Building, and both Campus Center-A and Campus Center-B.

Feeder 'D' feeds the Math Science Building chiller at 4160 volt and 5 sub-stations in the east tunnel serving both Engineering sub-stations, both Math/Science building sub stations and the Business/Journalism building sub-station. The planetarium is also fed from circuit D. The Chemistry Building has been disconnected.

Feeder 'E' serves the 2500kVA sub-station that serves the Central Plant.

Feeder 'F' is a new feeder that serves the Cafeteria and the Arts buildings and both their chillers at 4160 volts. The circuit then continues out the end of the east tunnel and serves the Maintenance & Operations Building and continues to the new Child Development Center.

Feeder 'G' is a new feeder that serves the new Student Services Building, Library/Resource Center, and the Theater Arts Building.

See Exhibits 5 for reference to the existing site electrical distribution system and existing campus single line diagram.

SYSTEM CAPACITY EVALUATION

The highest peak demand recorded in 2009 for the Central Plant meter by the campus was 2.2 Mega watts or 303 amps on the 1200 amp board. A review of the existing capacities of the feeders revealed that the existing electrical system is more than adequately sized to support the **existing** facilities at the campus. The total consumption for the whole campus for last year was approximately 9.1 million KW hours with a total electrical cost of \$1.03 million.

Table 5.1 below provides installed capacities by substations and feeders. Approximate demands of the buildings are calculated at 40% of the installed capacities in absence of a metered data available.

Table 5-1: Installed Capacities by Substation/Feeders

Feeder A

No.	LA Valley College Building Name	Installed Capacity in kVA	Demand in kVA
3	Foreign Language Building	161kVA	65kVA
54	Motion Picture Building	47kVA	19kVA
11	Music Building & Site Lighting	164kVA	126kVA
1	Administration	270kVA	108kVA
<b>Total</b>		<b>642kVA</b>	<b>318kVA</b>
		<b>89Amps</b>	<b>44Amps</b>

Feeder B

No.	LA Valley College Building Name	Installed Capacity in kVA	Demand in kVA
67	Women's Gym	304kVA	121KVA
7	Men's Gym	362KVA	145KVA
?	Pool	157KVA	157KVA
76	Allied Health Building	808KVA	323KVA
8	Life Science Building	192kVA	77kVA
<b>Total</b>		<b>1837kVA</b>	<b>829kVA</b>
		<b>255Amps</b>	<b>115Amps</b>

Feeder C

No.	LA Valley College Building Name	Installed Capacity in kVA	Demand in kVA
52	Behavioral Science Building	137kVA	55kVA
53	Humanities Building	194kVA	78KVA
56	Campus Center Building	836kVA	334KVA
<b>Total</b>		<b>1167kVA</b>	<b>467kVA</b>
		<b>162Amps</b>	<b>65Amps</b>

Feeder D

No.	LA Valley College Building Name	Installed Capacity in kVA	Demand in kVA
6	Engineering Building	241kVA	97kVA
50	Math Science Building	196KVA	78KVA
19	Business Journalism Building	226KVA	90KVA
51	Planetarium	93KVA	37KVA
<b>Total</b>		<b>756kVA</b>	<b>302kVA</b>
		<b>105Amps</b>	<b>42Amps</b>

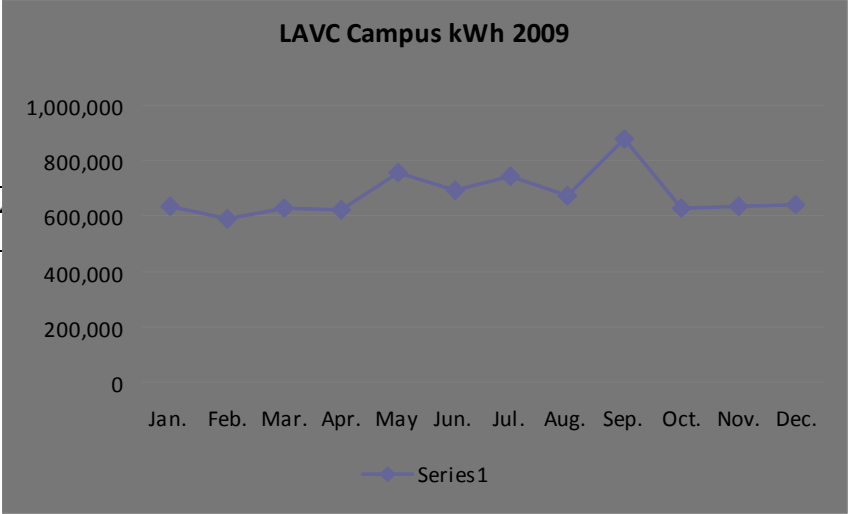
Feeder E

No.	LA Valley College Building Name	Installed Capacity in kVA	Demand in kVA
77	Central Plant	1600kVA	1600kVA
<b>Total</b>		<b>1933kVA</b>	<b>1933kVA</b>
		<b>268Amps</b>	<b>268Amps</b>

Feeder F

No.	LA Valley College Building Name	Installed Capacity in kVA	Demand in kVA
48	Art Building	190KVA	76KVA
75	M & O Building and Sheriff Office	265KVA	106KVA
V-70	Child Development Center	389KVA	155KVA
9	Cafeteria	294KVA	118KVA
<b>Total</b>		<b>1138kVA</b>	<b>455kVA</b>
		<b>158Amps</b>	<b>63Amps</b>

Graphs showing energy consumption and costs by each month for last year are also included below. LADWP calls "PEAK DEMAND" in there billing report "BILLING KW". The billing kW is the highest peak demand in a 15 minute period and LADWP will keep charging the highest peak demand for 12 full months before taking a new reading. Currently the billing kW is 2,207kW.

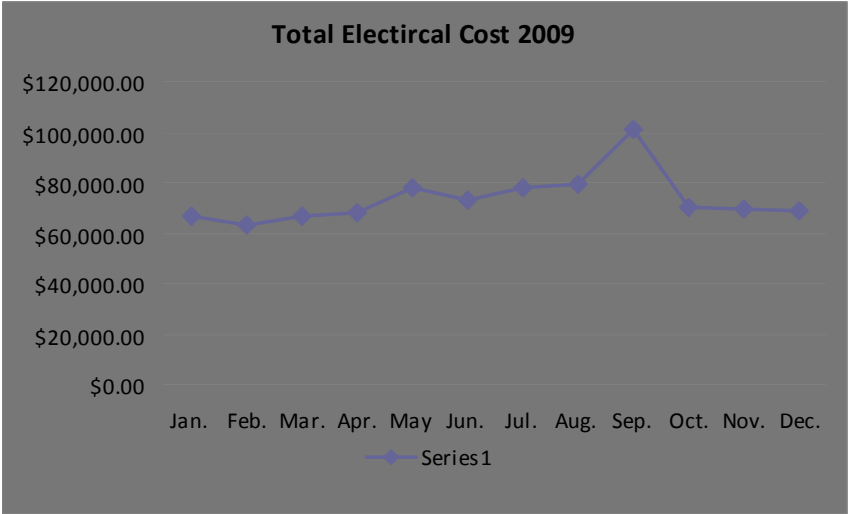


RENEWABLE POWER

The campus also has embarked on a number of renewable power projects aimed at reducing the greenhouse gas emissions at the campus. The renewable solar power is located at the Men's Gymnasium and the Allied Health Building and is proposed for the new Parking Structure. A **goal of 30% of all new construction** is planned at these facilities. This renewable power will help the campus offset the campus greenhouse gas emissions and help the campus shield itself from the variation in the energy prices. The system would also help the campus offset its peak campus demands in the summer and help towards achieving a carbon neutral status in the future.

Feeder G

No.	LA Valley College Building Name	Installed Capacity in kVA	Demand in kVA
102	Student Services	402kVA	161kVA
68	LLRC Library Building	929KVA	372KVA
10	Theater Art Building	217KVA	87KVA
54	Motion Picture Building	47KVA	19KVA
<b>Total</b>		<b>1708kVA</b>	<b>660kVA</b>
		<b>237Amps</b>	<b>92Amps</b>



Totals

<b>Grand Total</b>	<b>9114kVA</b>	<b>4926kva</b>
<b>4160V Load</b>	<b>1265Amps</b>	<b>684Amps</b>

5.4 ANALYSIS OF FUTURE NEEDS

An analysis of the current 4160V distribution system was conducted to evaluate a) existing spare capacities available at the main substation/feeders b) the impact of the proposed facilities on the existing electrical distribution system c) modifications required to support the future build out of the campus. The current electrical distribution was also analyzed for electrical duct-banks/manholes that will be in conflict with the proposed facilities and will require relocation. A campus site plan identifying electrical duct-banks/manholes that require demolition/relocation and extension of feeders to new facilities to serve the planned facilities is provided in our proposed electrical site plan.

An evaluation of the facilities of the master plan revealed that an additional 526,361 square feet of new buildings/spaces will be added with a net additional 322,604 square feet being added allowing for 203,757 square feet of building space to be demolished. A review of these proposed facilities and their usage revealed that the campus would add an additional installed capacity of 4,626KVA to their existing installed capacity. The watts per square foot for each building has been lowered from 16 to 10 watts to compensate for the fact that the AC load has been accounted for at the Central Plant. The Central Plant has enough capacity for all additional building through 2014 and will not require additional load. See Central Plant Section 10. Based on a demand factor of 40% (which the current campus currently sees with their existing facilities), the campus will see an additional demand of 2284kVA making the total demand of the campus at 6,027kVA.

A review of the demand of these future installed facilities and current demand of the campus revealed that the main 4160 V switchgear is adequately sized to meet the demands of existing and future facilities. The campus currently has a peak demand of 2.2kW on the Central Plant Meter with an assumed power factor of 0.88 that is expected to grow to approximately 6,027kVA with the addition of these new facilities and additions. This future estimate is projected based on the campus current ratio of installed capacity versus its current demand. The 1200 amp switchgear will be loaded to 837amps.

The following table 5.2 depicts campus installed capacity and demand progression over time due to new facilities that are being added under the proposed facilities master plan funding as part of the passed **bond measure J**.

Table 5.2 Installed Capacities/Demand of Future Facilities-2010

Building Name	Building No.	Projected Construction Completion Year	Gross sqft	No. of Stories	Required Capacity in kVA	Demand In kVA @40% of Installed Capacity
Child Development Center	V70	2010	25,904	1	389	155
Student Services	102	2010	40,186	2	402	161
Library LLRC	68	2010	92,992	3	929	372
<b>Total Capacity Addition</b>			<b>159,082</b>		<b>2408</b>	<b>688</b>

Installed Capacities/Demand of Future Facilities-2012

Building Name	Building No.	Projected Construction Completion Year	Gross Sqft	No. Of Stories	Required Capacity In Kva	Demand In Kva @40% Of Installed Capacity
Athletic Training Center	V13	2012	18,000	2	180	72
Field House	V14	2012	3,000	1	30	12
<b>Total Capacity Addition</b>			<b>21,000</b>		<b>210</b>	<b>84</b>

Installed Capacities/Demand of Future Facilities-2013

Building Name	Building No.	Projected Construction Completion Year	Gross sqft	No. of Stories	Required Capacity in kVA	Demand In kVA @40% of Installed Capacity
Media arts Center	V11	2013	62,000	1	600	248
Administration	V12	2013	79,486	2	795	318
Performance Arts Center	V15	2013	21,693	1	217	87
Multi-purpose	V16	2013	30,000	2	300	120
Student Union	V22	2013	55,538		535	214
<b>Total Capacity Addition</b>			<b>248,717</b>		<b>2447</b>	<b>987</b>

Installed Capacities/Demand of Future Facilities-2014

Building Name	Building No.	Projected Construction Completion Year	Gross sqft	No. of Stories	Required Capacity in kVA	Demand In kVA @40% of Installed Capacity
Parking Structure	V18	2014	96000	4	120	48
<b>Total Capacity Addition</b>			<b>80,000</b>		<b>1000</b>	<b>250</b>

5.5 FINDINGS AND RECOMMENDATIONS

A critical aspect in evaluating the reliability of a system is to study the failure rates from the utility and failure rates internal to the campus in the past. Discussions with the campus maintenance staff revealed that there have been minimum failures in the campus owned 5kV distribution system.

The campus however needs to have a complete redundant system to help isolate each building on campus and also be able to conduct maintenance on a feeder without affecting power service to each building on campus.

In order to provide the campus with redundancy and capability of scheduling maintenance on high voltage equipment without interrupting power to the campus, a closed loop configuration is recommended.

This system would provide the campus with the ease of isolating faults within the campus distribution system and minimize power interruptions to the buildings during maintenance on the medium voltage distribution system.

Below is a brief description of a closed loop system with isolating or selector switches at each building. The recommendations have been categorized into three priority levels. Descriptions of each priority level are provided in the executive summary of this report.

Closed Loop System

A primary closed loop system with isolating switches at each building offers improved system reliability and service continuity in comparison to a radial distribution system. In this system, power is supplied continuously from two sources at the ends of the loop. A properly designed loop quickly recovers from a single cable fault with no continuous loss of power to utilization equipment.

A second important feature of the closed loop system is that a section of the cable may be isolated from the loop for repair or maintenance while other parts of the system are still functioning.

Following are thus our recommendations to upgrade the existing electrical infrastructure at the campus to (a) Improve system reliability (b) provide

ease of maintenance and isolation of circuits either during a fault or during a regular maintenance without interrupting power to every building on campus (c) to provide adequate capacity of feeders to accommodate existing loads and planned future loads resulting from new buildings addition as well as additions to existing buildings (d) be well coordinated to eliminate nuisance tripping of upstream protective devices (e) have all equipment listed for the short circuit availability at the point of installation.

Priority 1

- The new athletic buildings were chosen for a **closed loop system on new circuit H and the return path, circuit B, already exists out to the women’s gym**. Circuit B will be converted from a radial feeder to a closed loop system. Selector switches will provide ease of isolation of loop faults as well as provide a means of isolating building substations. These switches will be served from the nearest existing pullbox located close to the proposed facility as shown in our proposed site plan. Radial feeders originating from these selector switches will serve substations in each of the facilities. Other circuits were not selected for a closed loop system due to the fact that only three or four buildings were on a radial feeder and did not warrant a new system.
- We recommend that conductors in **feeder loop B/H be upsized** from 3#3/0 to 3# 500kcmil. MV-105 133% EPR copper shielded cables.
- We recommend a **coordination study** of the proposed system to effectively coordinate all protective devices in the campus.
- Conduct a **Short Circuit / Arc Flash study** should be conducted to coordinate the existing system. See sample below.
- We recommend the campus take advantage of the Los Angeles Department of Water and Power (LADWP) incentives and **rebate programs** previously offered at LAUSD and community colleges. They offer \$750 per kilowatt shifted from **PEAK** demand time to **OFF PEAK** demand time. For a 900 TON thermal energy storage system (TES) the rebate could be as large as \$300 thousand dollars.

- We recommend that **LADWP** be notified of any new construction. They are not always notified of new buildings or loads being installed that could effect the size of there transformer.

Priority 2

- We recommend that the Campus Center building that contains the Alpha Data Center be placed on an electrical loop instead of a radial feeder. Switchboard MSA’s **Feeder C and Feeder D should be combined to form a loop system** to avoid power outages for the Alpha Data Center.
- We recommend that the utility tunnels be **water proofed and sealed**. We also recommend that the local leak detectors be tied into a **central alarm system** rather than local alarms.

Priority 3

- We recommend the use of a **wireless multi-metering system**. The system should have an energy software package for energy analysis, 3 phase wireless meter transceivers for wireless metering and be capable of metering at 480 volts as well as 208 volts.
- We recommend that the **walkway lights and sump pumps** in the utility tunnels be fed from one local panel from a transformer that is in use in each tunnel. We also recommend the spare transformers in the tunnels be removed. Currently the Physics Building and Chemistry Building transformers are being energized just to light up the tunnels.
- We recommend that the campus walkway lights be connected to the **TRIDIUM lighting system** in the west utility tunnel near the Administration Building.
- We recommend the use of **energy efficient light fixtures** throughout the campus for all existing buildings.
- We recommend that **above ground electrical equipment** be use for buildings at the lower south end of the utility tunnels to avoid power outages due to flooding. The buildings that we recommend having their

electrical equipment located above ground are the Life/Science building in the east tunnel, the Business/Journalism Building and the Math Science Buildings in the west tunnel.

Our proposed single line diagram and electrical site plan is included in the figures at the end of the section.

The following are our recommendations for serving the proposed facilities as they are being added on in various phases to the existing campus electrical distribution system.

Sample Arc Flash Warning



Table 5.3 below provides installed capacities by substations and feeders for all existing and proposed buildings through 2014. Approximate demands of the buildings are calculated at 40% of the installed capacities in absence of a metered data available. The capacities are calculated based on the industry standard watts per square foot and shows the load for the main switchboard.

Table 5-3: Installed Capacities by Substation/Feeders

Feeder A

No.	LA Valley College Building Name	Installed Capacity in kVA	Demand in kVA
3	Foreign Language Building	161kVA	65kVA
54	Motion Picture Building	47kVA	19kVA
11	Music Building & Site Lighting	164kVA	126kVA
V12	Administration	795kVA	318kVA
V11 V15	Media Arts/Performance Arts	837kVA	335kVA
<b>Totals</b>		<b>2004kVA</b>	<b>863kVA</b>
		<b>287Amps</b>	<b>120Amps</b>

Feeder loop B/H

No.	LA Valley College Building Name	Installed Capacity in kVA	Demand in kVA
67	Women's Gym	304kVA	121KVA
7	Men's Gym	362KVA	145KVA
	Pool	157KVA	157KVA
76	Allied Health Building	808KVA	323KVA
V18	Parking Structure & Future 600 Ton Chiller Plant	436kVA	436kVA
V16	Multi-purpose Center	300kVA	120kVA
V13	Athletic Training Center	400kVA	160kVA
V14	Baseball Field House	250kVA	100kVA
	Tennis Courts	50kVA	50kVA
<b>Totals</b>		<b>3067kVA</b>	<b>1612kVA</b>
		<b>426Amps</b>	<b>224Amps</b>

Feeder C

No.	LA Valley College Building Name	Installed Capacity in kVA	Demand in kVA
52	Behavioral Science Building	137kVA	55kVA
53	Humanities Building	194kVA	78KVA
56	Campus Center Building	836kVA	334KVA
<b>Totals</b>		<b>1167kVA</b>	<b>467kVA</b>
		<b>162Amps</b>	<b>65Amps</b>

Feeder D

No.	LA Valley College Building Name	Installed Capacity in kVA	Demand in kVA
6	Engineering Building	241kVA	97kVA
50	Math Science Building	196KVA	78KVA
19	Business Journalism Building	226KVA	90KVA
51V5 1	Planetarium	93KVA	37KVA
<b>Totals</b>		<b>756kVA</b>	<b>302kVA</b>
		<b>105Amps</b>	<b>42Amps</b>

Feeder E

No.	LA Valley College Building Name	Installed Capacity in kVA	Demand in kVA
77	Central Plant	1933kVA	1933kVA
<b>Totals</b>		<b>1933kVA</b>	<b>1933kVA</b>
		<b>268Amps</b>	<b>268Amps</b>

Feeder F

No.	LA Valley College Building Name	Installed Capacity in kVA	Demand in kVA
48	Art Building	190KVA	76KVA
75	M & O Building and Sheriff Office	265KVA	106KVA
V22	Student Union	535KVA	214KVA
V-70	Child Development Center	389KVA	155KVA
V71	Family Resource Center	133KVA	53KVA
<b>Totals</b>		<b>1644kVA</b>	<b>657kVA</b>
		<b>228Amps</b>	<b>91Amps</b>

Feeder G

No.	LA Valley College Building Name	Installed Capacity in kVA	Demand in kVA
102	Student Services	402kVA	161kVA
68	LRC Library Building	929KVA	372KVA
54	Motion Picture Building	47KVA	19KVA
<b>Totals</b>		<b>1378kVA</b>	<b>552kVA</b>
		<b>191Amps</b>	<b>77Amps</b>



<b>Grand Total</b>		<b>11949kVA</b>	<b>6,386kVA</b>
<b>4160V Load</b>		<b>1,658 Amps</b>	<b>886Amps</b>

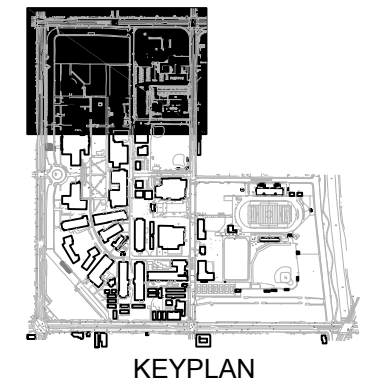
**LOS ANGELES VALLEY COLLEGE – MEASURE J UTILITY MASTER PLAN  
APRIL 26, 2010**

The following Table 5-4 depicts all the existing Department of Water and Power meters currently on the campus and there locations. All but 2 of these meters will be removed when Measure J is implemented. The Central Plant and the Stadium meters will remain.

Address	Location	Meter #	Switchboard Rating	Voltage	Peak KW Demand	Amps
5800 Fulton Av	Central Plant	ANPMVL03525-0060	1200A	4160V	2207	319
5720 Ethel Av.	Gymnastics Bldg	M00019-00002988	400 A	120/240V-1PH-3W	45	218
13161 Burbank Ave	Bungalow 48	1APM3D00022 - 00200242	800A	120/240V 1PH-3W	138	686
13161 Burbank Ave	Bungalow 48	PM00219 - 00005819	200A	240V 3PH-3W	8	19
5800 Ethel Ave	Stadium	APMD00422 - 00002711	600A	480V 3PH	155	219
5929 Ethel Ave	Child Care Center	AM00019 - 00065560	400A	120/240V-1PH-3W	41	170
5750 Ethel Ave	Field House	AM00015 - 00010169	400 A	120/240V-1PH-3W	23	113

**LEGEND:**

-  EXISTING BUILDING
-  EXISTING ELEC. LINE



**NOTE:**

1. REFER TO TABLES ES-1 AND ES-2 FOR BUILDING NAMES.
2. THE INFORMATION SHOWN HEREON IS A GRAPHICAL DEPICTION OF THE EXISTING CAMPUS UTILITY SYSTEMS. THE SITE SURVEY AND INFRASTRUCTURE STUDIES EXISTING UTILITY PLANS PREPARED UNDER SEPARATE COVER SHALL BE REFERENCED FOR DETAILED INFORMATION

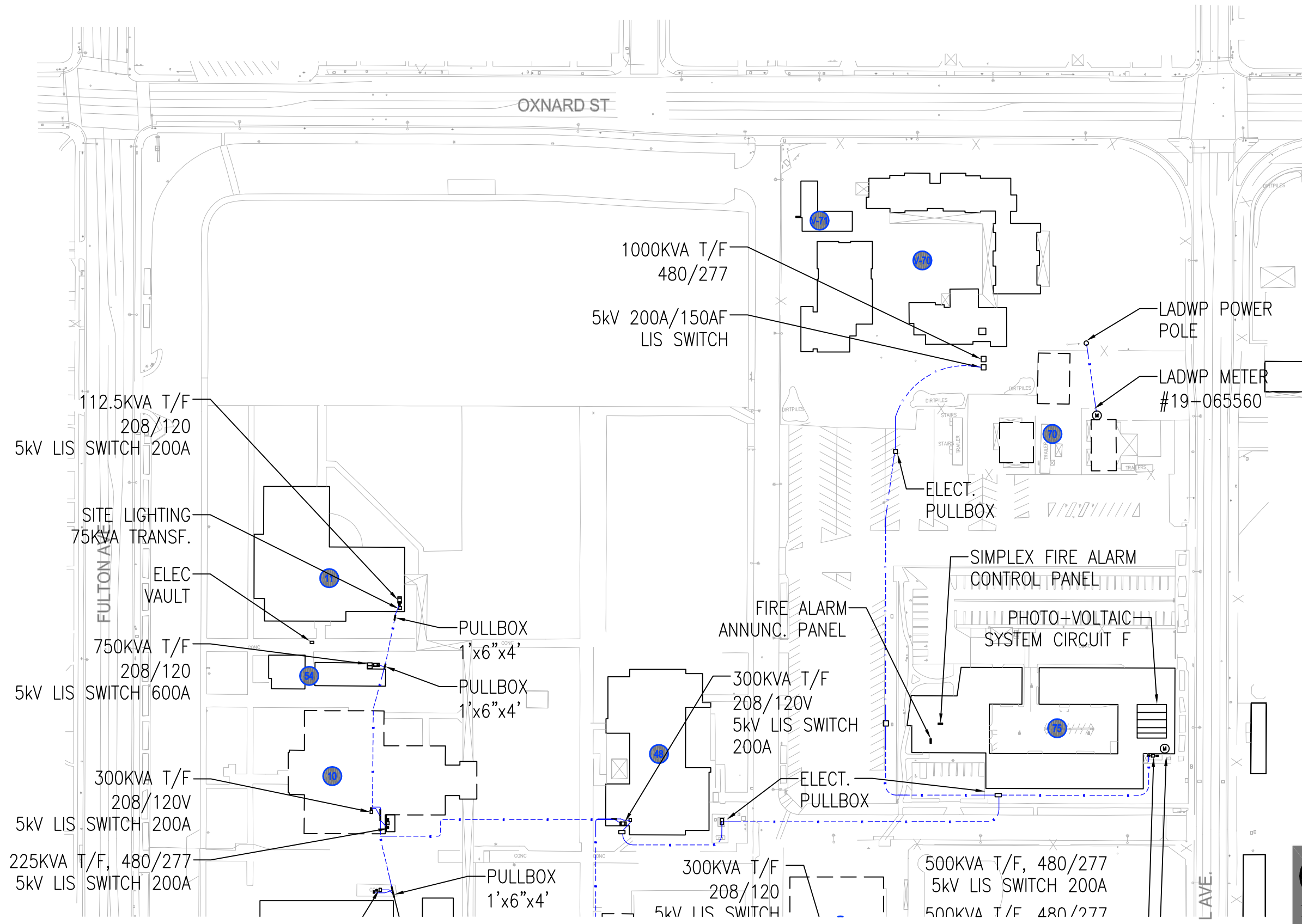
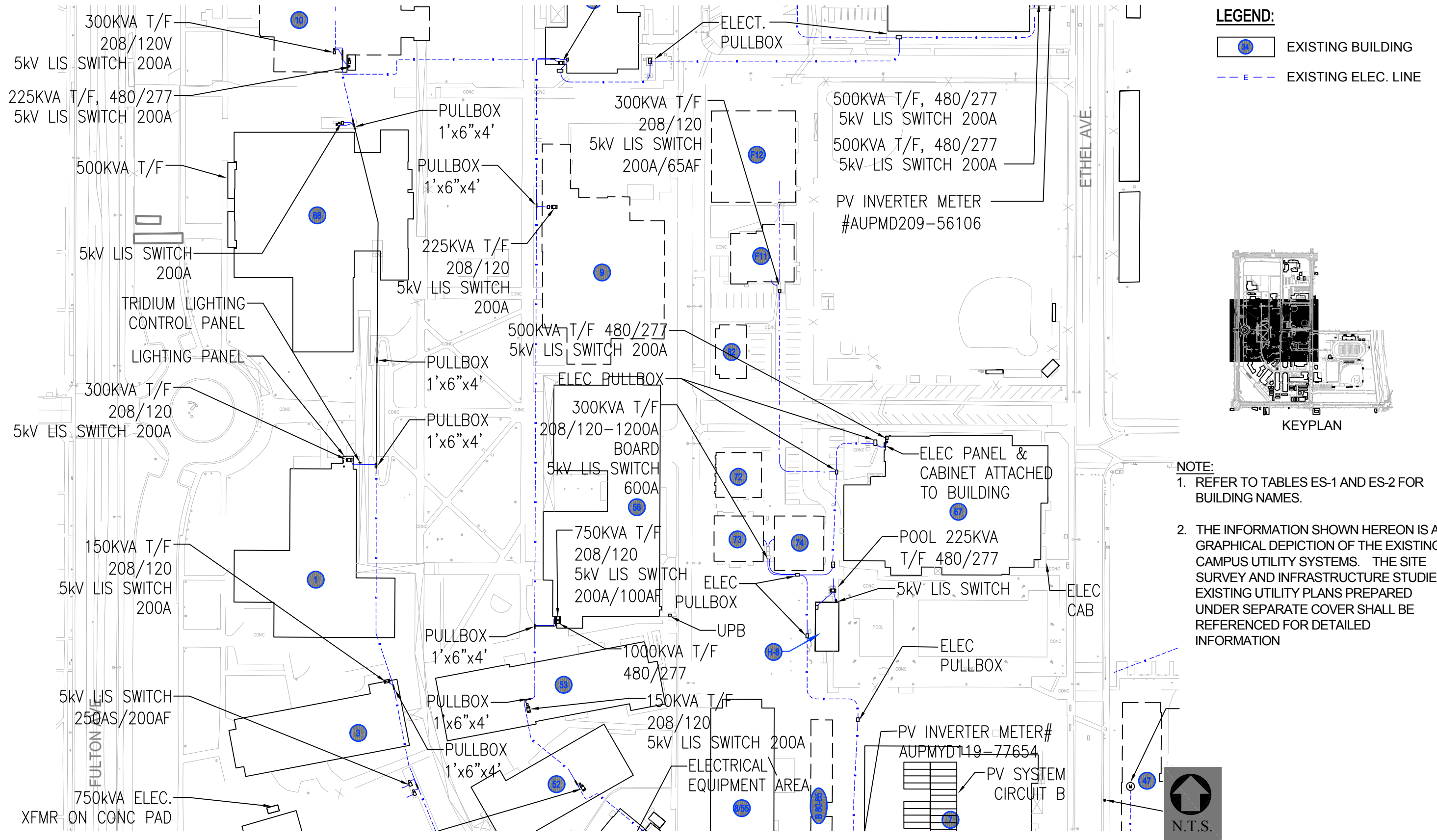
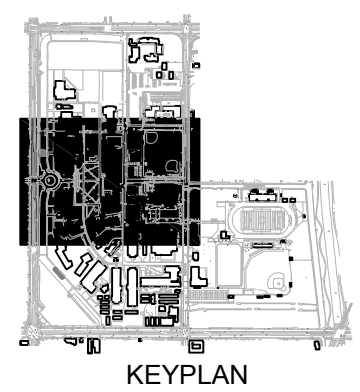


FIGURE 5a  
 EXISTING CONDITIONS UTILITY MAP - ELECTRICAL

*(Page Intentionally Left Blank)*



**LEGEND:**  
 EXISTING BUILDING  
 EXISTING ELEC. LINE



**NOTE:**  
 1. REFER TO TABLES ES-1 AND ES-2 FOR BUILDING NAMES.  
 2. THE INFORMATION SHOWN HEREON IS A GRAPHICAL DEPICTION OF THE EXISTING CAMPUS UTILITY SYSTEMS. THE SITE SURVEY AND INFRASTRUCTURE STUDIES EXISTING UTILITY PLANS PREPARED UNDER SEPARATE COVER SHALL BE REFERENCED FOR DETAILED INFORMATION

FIGURE 5b  
 EXISTING CONDITIONS UTILITY MAP - ELECTRICAL

*(Page Intentionally Left Blank)*

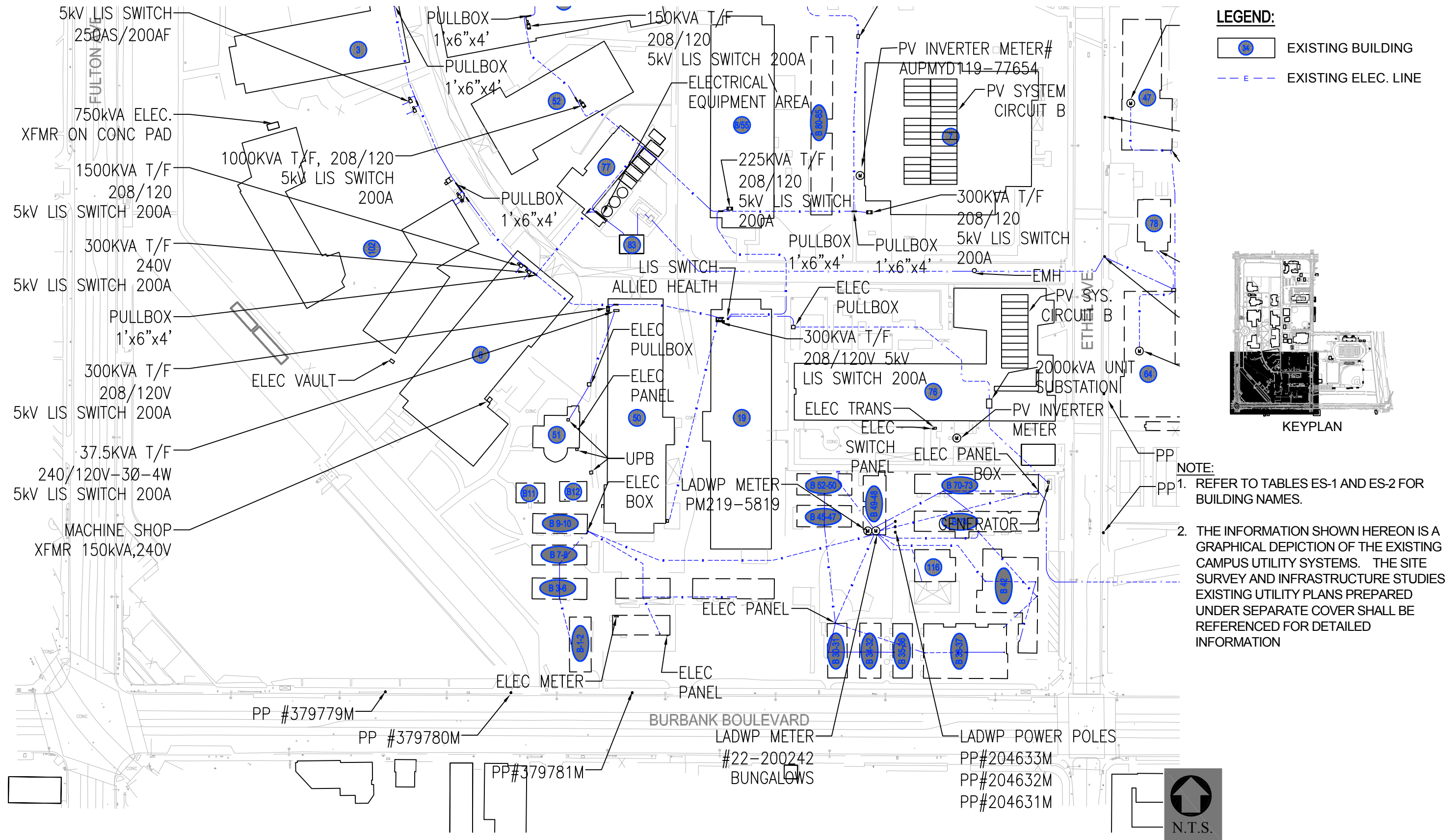
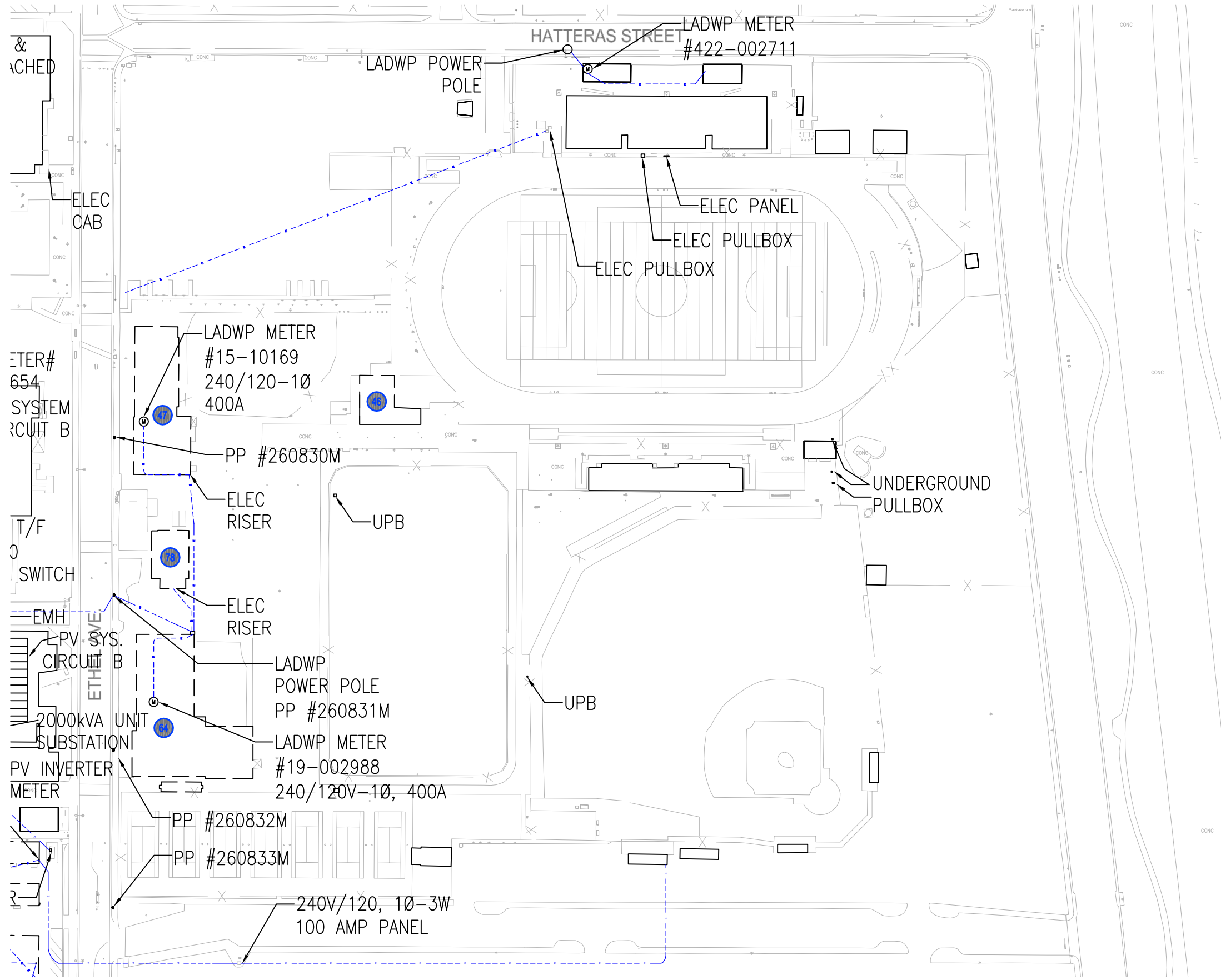


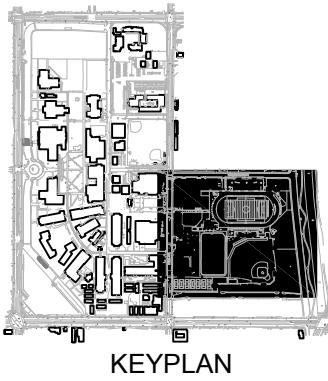


FIGURE 5c  
 EXISTING CONDITIONS UTILITY MAP - ELECTRICAL

*(Page Intentionally Left Blank)*



**LEGEND:**  
 EXISTING BUILDING  
 EXISTING ELEC. LINE



**NOTE:**  
 1. REFER TO TABLES ES-1 AND ES-2 FOR BUILDING NAMES.  
 2. THE INFORMATION SHOWN HEREON IS A GRAPHICAL DEPICTION OF THE EXISTING CAMPUS UTILITY SYSTEMS. THE SITE SURVEY AND INFRASTRUCTURE STUDIES EXISTING UTILITY PLANS PREPARED UNDER SEPARATE COVER SHALL BE REFERENCED FOR DETAILED INFORMATION



FIGURE 5d  
 EXISTING CONDITIONS UTILITY MAP - ELECTRICAL

*(Page Intentionally Left Blank)*

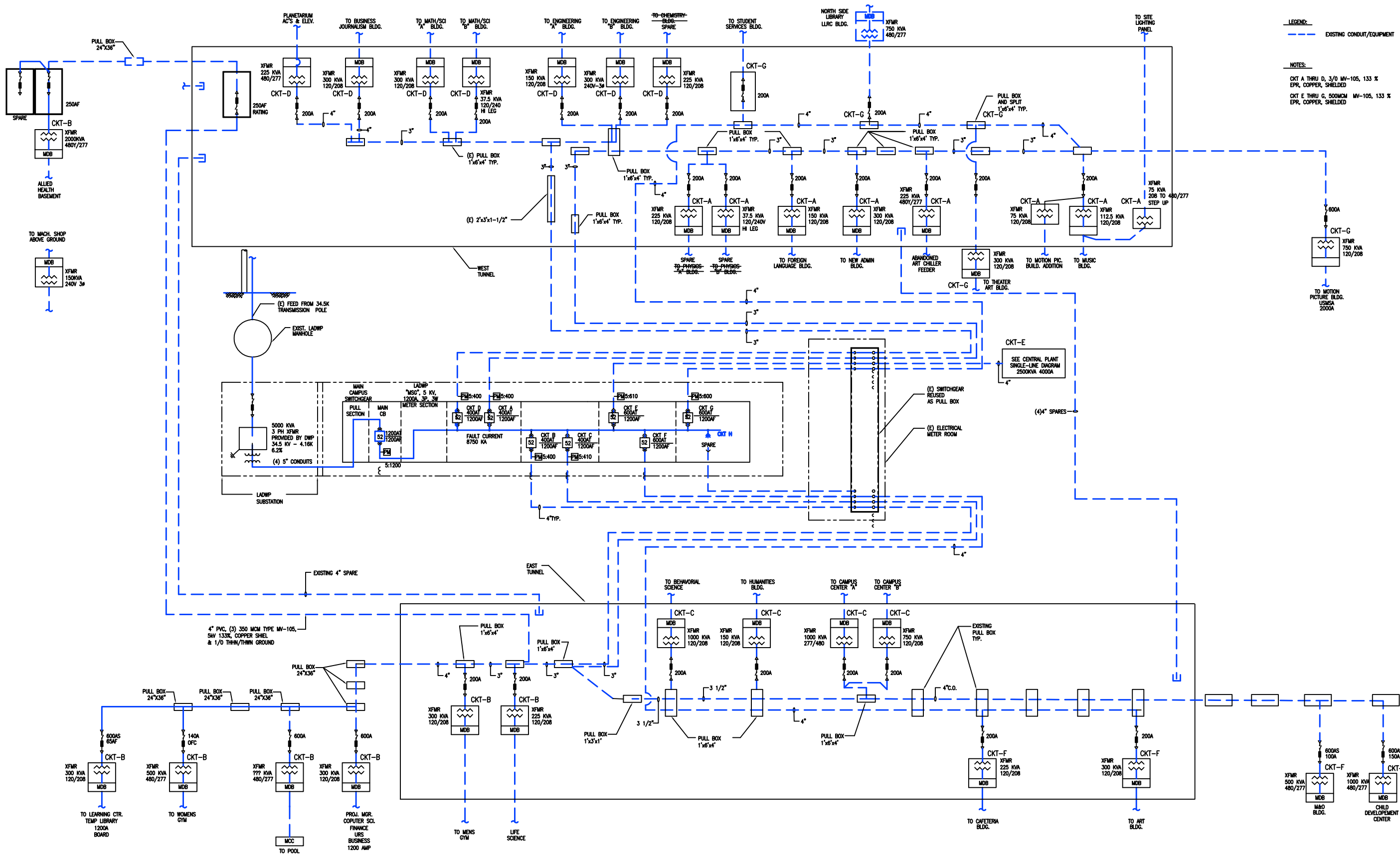




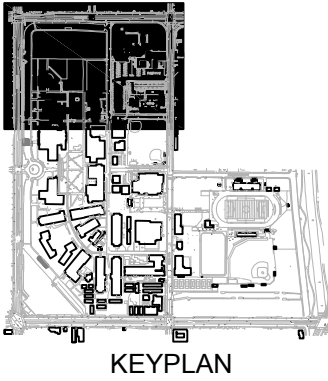


FIGURE 5e  
 EXISTING CONDITIONS ELECTRICAL SYSTEM - SINGLE LINE DAIGRAM

*(Page Intentionally Left Blank)*

**LEGEND:**

-  EXISTING BUILDING
-  PROPOSED MEASURE J BUILDING
-  EXISTING ELEC. LINE
-  PROPOSED ELEC. LINE



**NOTE:**

1. REFER TO TABLES ES-1 AND ES-2 FOR BUILDING NAMES.
2. THE INFORMATION SHOWN HEREON IS A GRAPHICAL DEPICTION OF THE EXISTING CAMPUS UTILITY SYSTEMS. THE SITE SURVEY AND INFRASTRUCTURE STUDIES EXISTING UTILITY PLANS PREPARED UNDER SEPARATE COVER SHALL BE REFERENCED FOR DETAILED INFORMATION
3. FUTURE CONDITIONS UTILITY MAPS SHOW ONLY THE DISPOSITION OF FUTURE BUILDINGS. REFER TO FIGURE 0e-MEASURE J MASTER PLAN SUMMARY FOR COMPLETE LAYOUT OF FUTURE CONDITIONS.

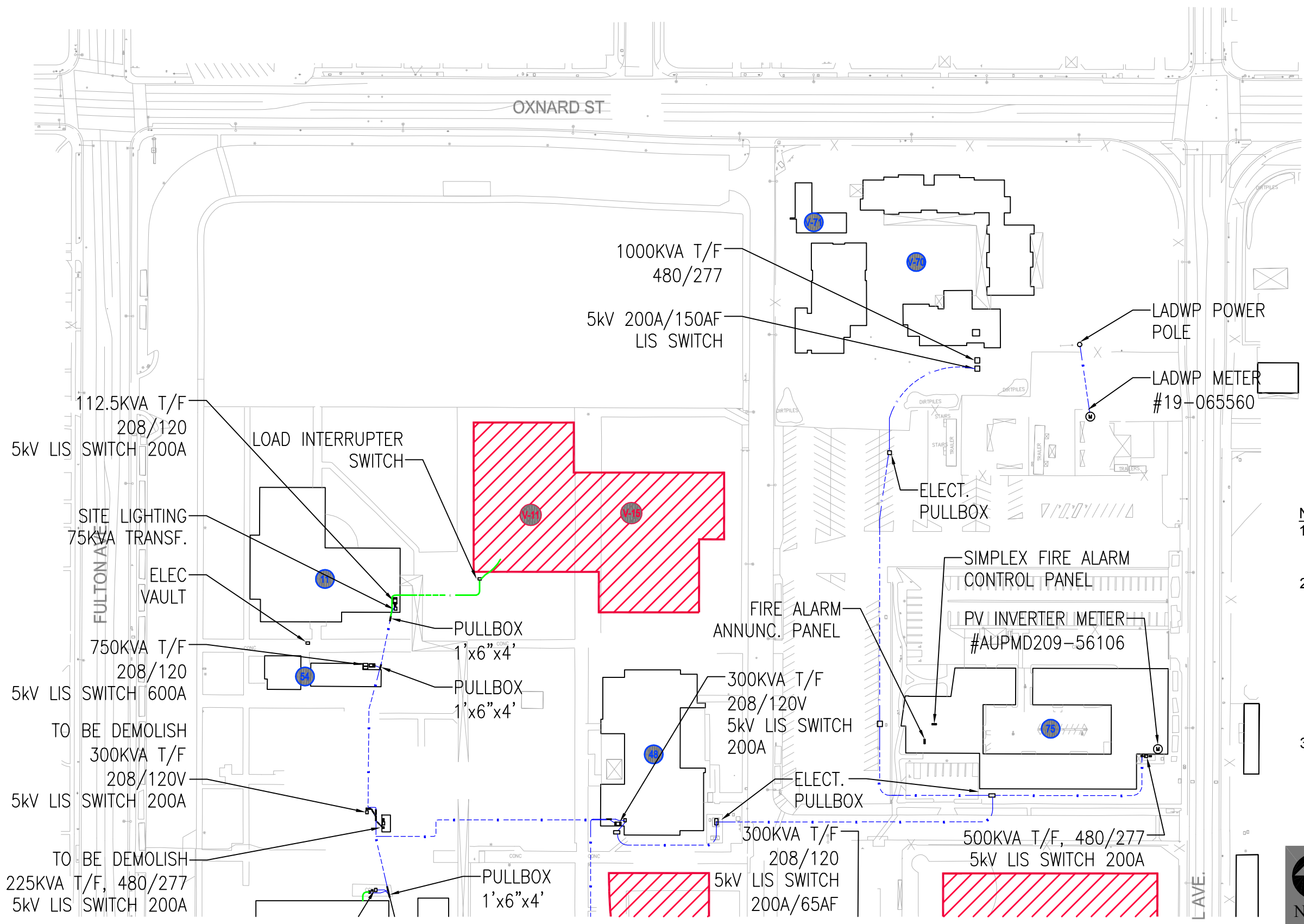
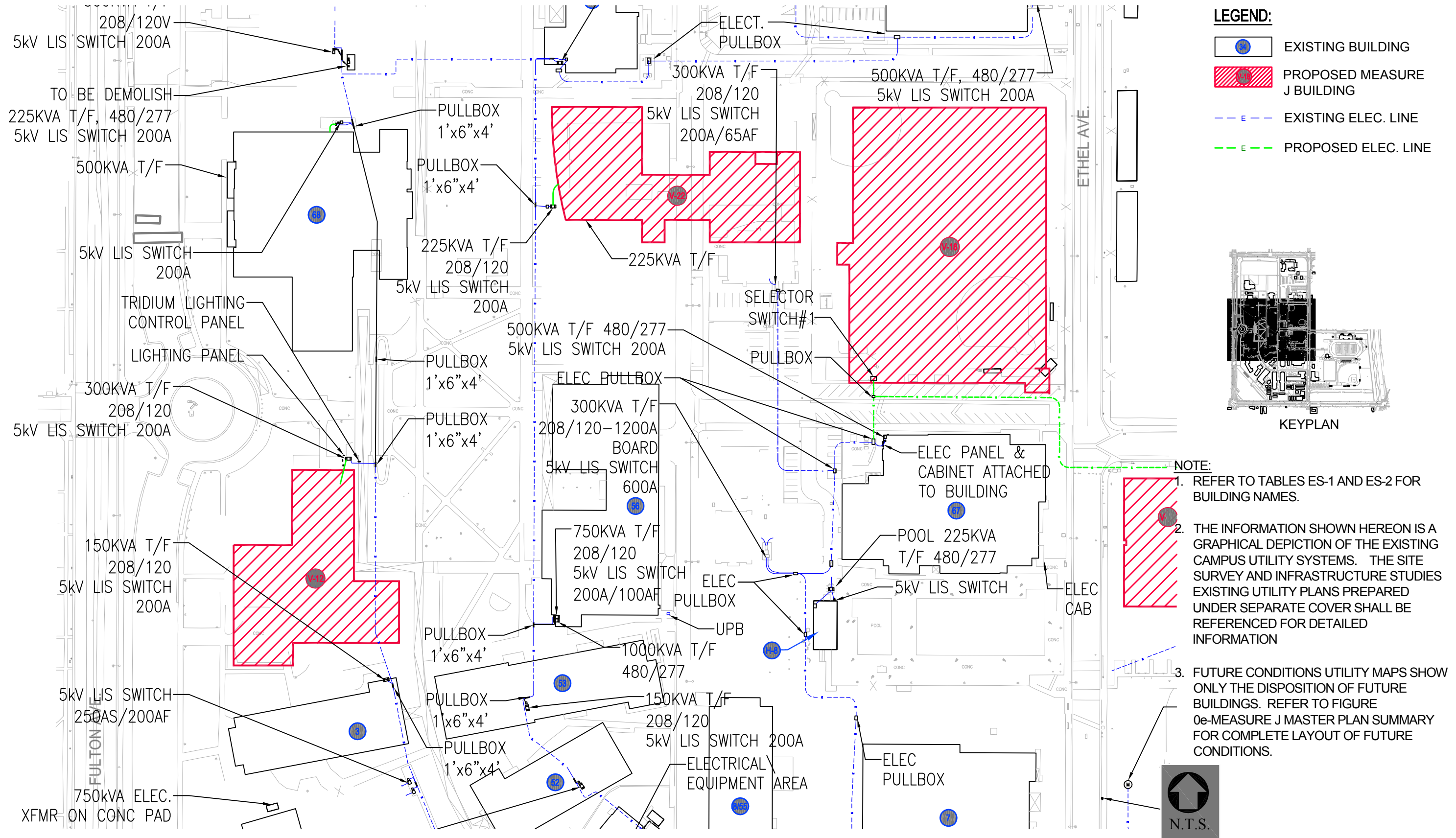


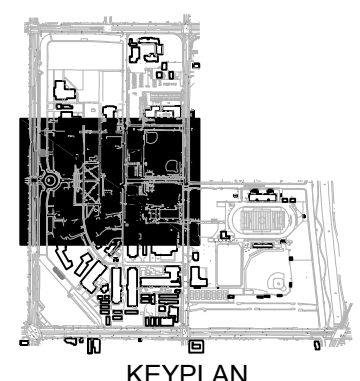
FIGURE 5f  
 FUTURE CONDITIONS UTILITY MAP - ELECTRICAL

*(Page Intentionally Left Blank)*



**LEGEND:**

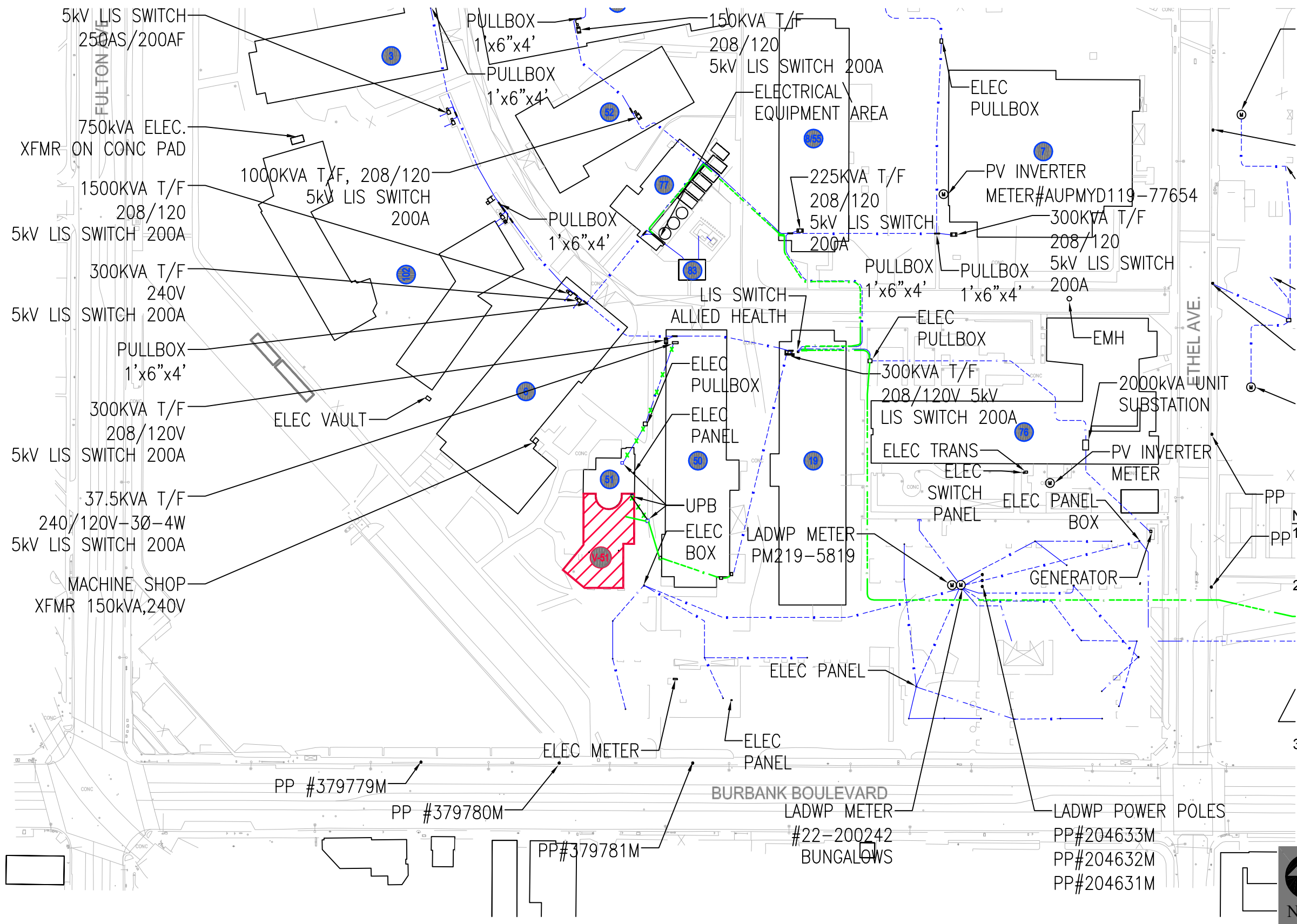
- EXISTING BUILDING
- PROPOSED MEASURE J BUILDING
- EXISTING ELEC. LINE
- PROPOSED ELEC. LINE



- NOTE:**
1. REFER TO TABLES ES-1 AND ES-2 FOR BUILDING NAMES.
  2. THE INFORMATION SHOWN HEREON IS A GRAPHICAL DEPICTION OF THE EXISTING CAMPUS UTILITY SYSTEMS. THE SITE SURVEY AND INFRASTRUCTURE STUDIES EXISTING UTILITY PLANS PREPARED UNDER SEPARATE COVER SHALL BE REFERENCED FOR DETAILED INFORMATION
  3. FUTURE CONDITIONS UTILITY MAPS SHOW ONLY THE DISPOSITION OF FUTURE BUILDINGS. REFER TO FIGURE 0e-MEASURE J MASTER PLAN SUMMARY FOR COMPLETE LAYOUT OF FUTURE CONDITIONS.

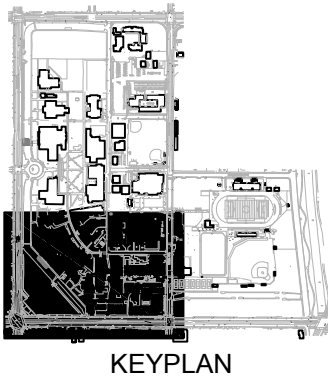
FIGURE 5g  
 FUTURE CONDITIONS UTILITY MAP - ELECTRICAL

*(Page Intentionally Left Blank)*



**LEGEND:**

- EXISTING BUILDING
- PROPOSED MEASURE J BUILDING
- EXISTING ELEC. LINE
- PROPOSED ELEC. LINE

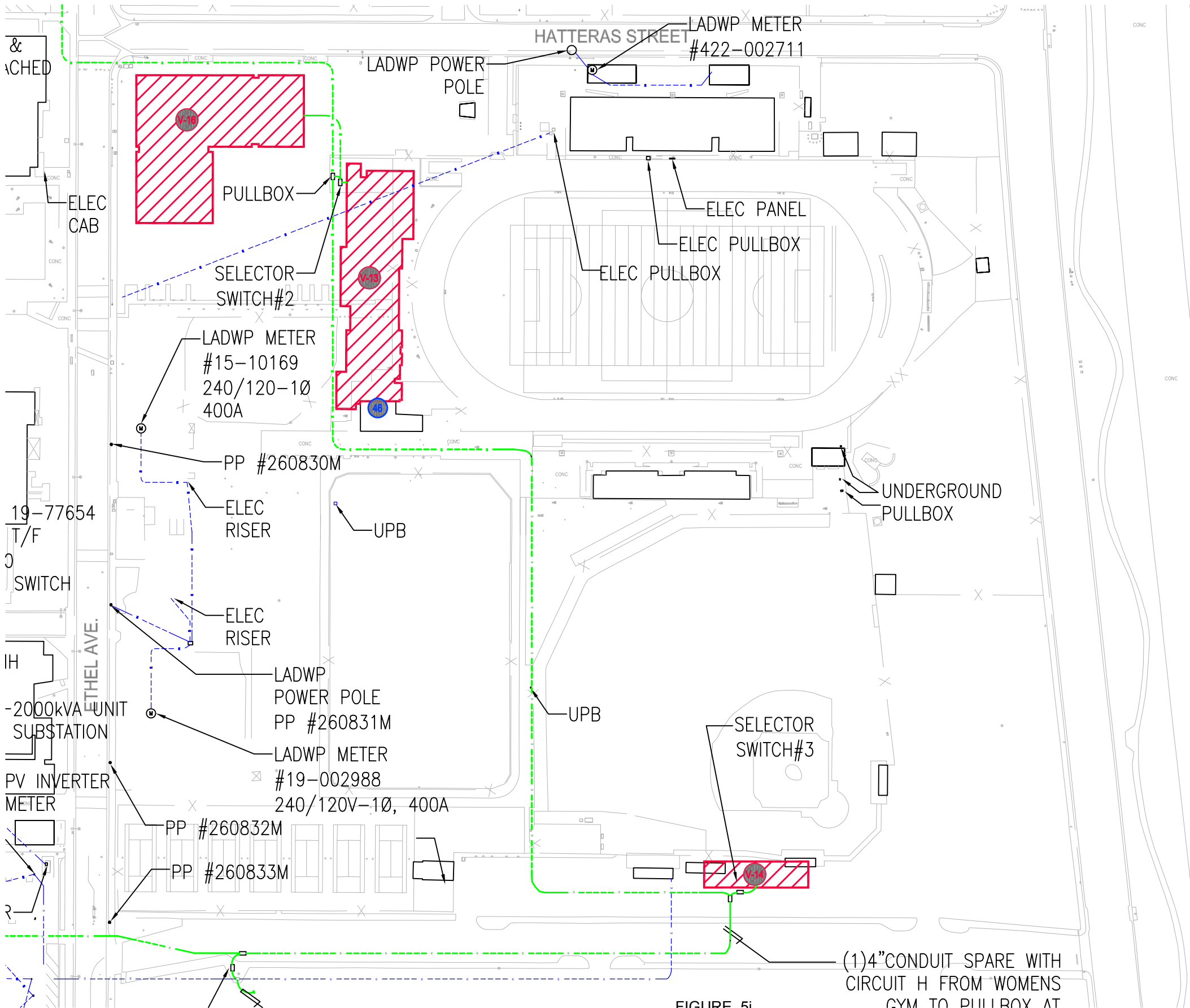






- NOTE:**
1. REFER TO TABLES ES-1 AND ES-2 FOR BUILDING NAMES.
  2. THE INFORMATION SHOWN HEREON IS A GRAPHICAL DEPICTION OF THE EXISTING CAMPUS UTILITY SYSTEMS. THE SITE SURVEY AND INFRASTRUCTURE STUDIES EXISTING UTILITY PLANS PREPARED UNDER SEPARATE COVER SHALL BE REFERENCED FOR DETAILED INFORMATION
  3. FUTURE CONDITIONS UTILITY MAPS SHOW ONLY THE DISPOSITION OF FUTURE BUILDINGS. REFER TO FIGURE 0e-MEASURE J MASTER PLAN SUMMARY FOR COMPLETE LAYOUT OF FUTURE CONDITIONS.

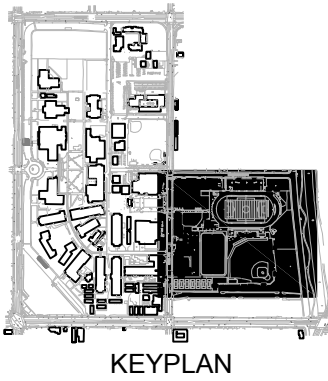


FIGURE 5h  
 FUTURE CONDITIONS UTILITY MAP - ELECTRICAL

*(Page Intentionally Left Blank)*



- LEGEND:**
-  EXISTING BUILDING
  -  PROPOSED MEASURE J BUILDING
  -  EXISTING ELEC. LINE
  -  PROPOSED ELEC. LINE



- NOTE:**
1. REFER TO TABLES ES-1 AND ES-2 FOR BUILDING NAMES.
  2. THE INFORMATION SHOWN HEREON IS A GRAPHICAL DEPICTION OF THE EXISTING CAMPUS UTILITY SYSTEMS. THE SITE SURVEY AND INFRASTRUCTURE STUDIES EXISTING UTILITY PLANS PREPARED UNDER SEPARATE COVER SHALL BE REFERENCED FOR DETAILED INFORMATION
  3. FUTURE CONDITIONS UTILITY MAPS SHOW ONLY THE DISPOSITION OF FUTURE BUILDINGS. REFER TO FIGURE 0e-MEASURE J MASTER PLAN SUMMARY FOR COMPLETE LAYOUT OF FUTURE CONDITIONS.



FIGURE 5i  
 FUTURE CONDITIONS UTILITY MAP - ELECTRICAL

*(Page Intentionally Left Blank)*

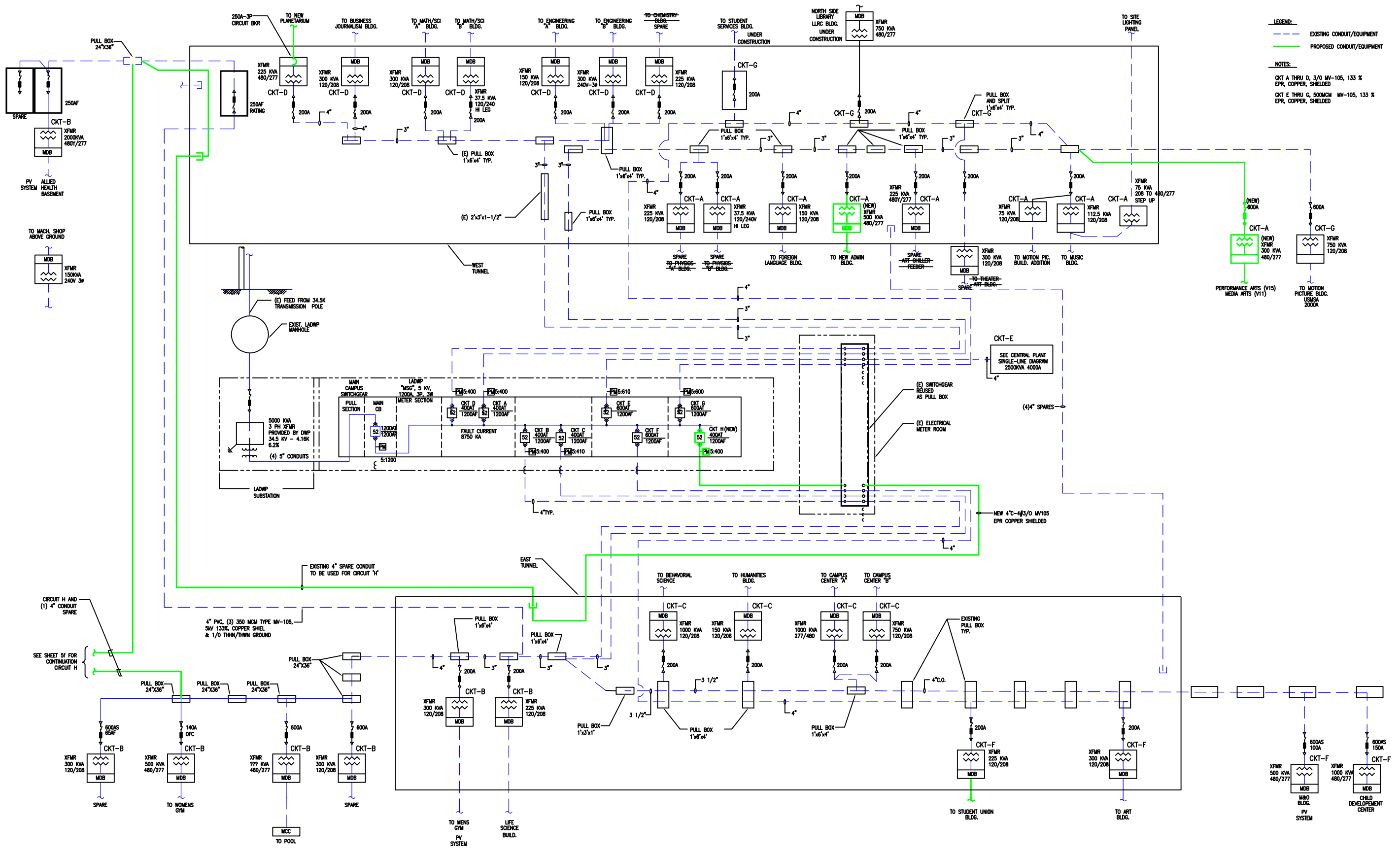


FIGURE 5j  
 FUTURE CONDITIONS ELECTRICAL SYSTEM - SINGLE LINE DAIGRAM

*(Page Intentionally Left Blank)*

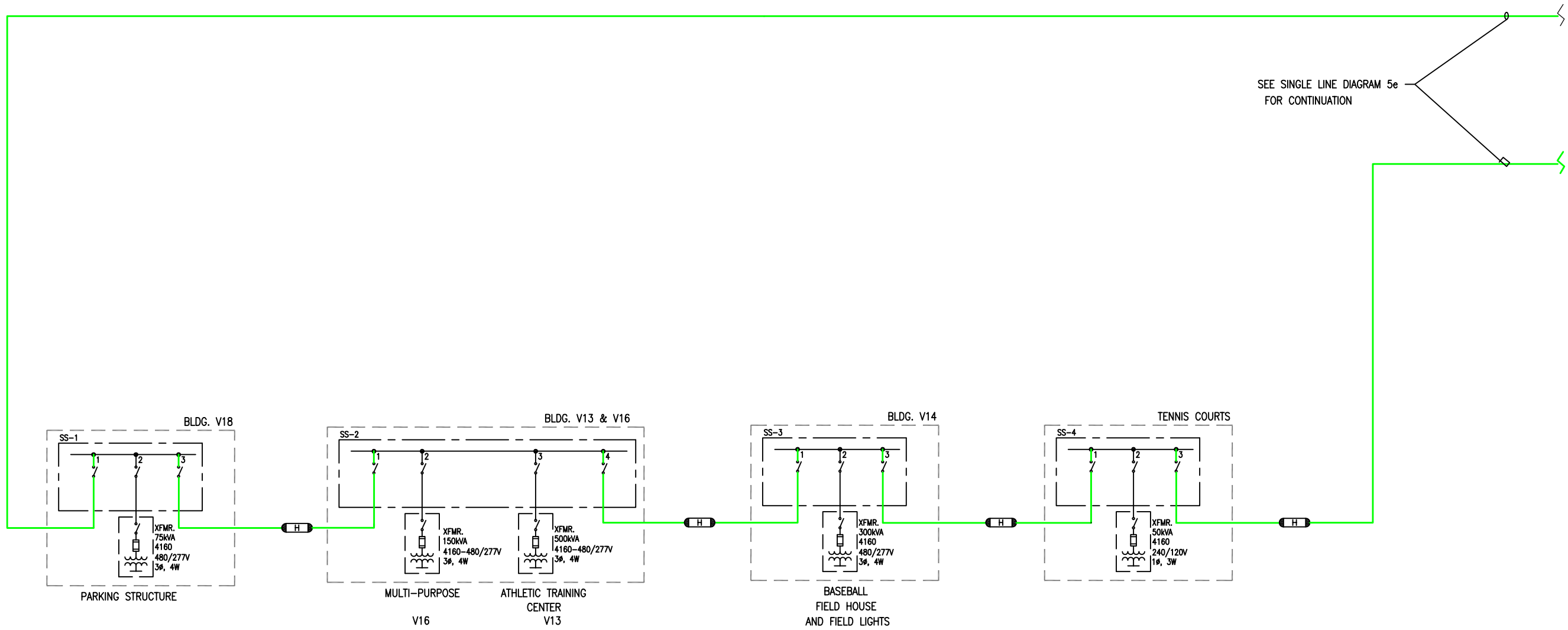
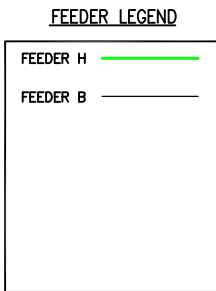


FIGURE 5k  
 FUTURE CONDITIONS ELECTRICAL SYSTEM - SINGLE LINE DIAGRAM FEEDER- H

*(Page Intentionally Left Blank)*

## SECTION 6 – TELECOMMUNICATIONS SYSTEMS

### 6.1 SYSTEM DESCRIPTION

The most recently constructed Utilities Infrastructure project provided a new conduit and pull-box system throughout the existing utility tunnel for fiber and copper to most of the buildings on campus. The buildings east of Ethel Ave (Gym Center, H78, and Community Services/Field house), Bungalows, Motion Picture, Central Plant, and the Planetarium Building were not covered under this project. We will refer to this latest project as the Utilities Infrastructure System (UI).

The UI project provided new conduits to connect the Alpha and Omega Data Centers and both ends of the West and East utility tunnels to provide a continuous loop system. The Alpha Data Center (Primary) is located in the Campus Center Building and the Omega Data Center (Secondary) is located in the Administration Building. The data centers are connected with fiber optic cables. The UI project provided a redundant fiber backbone by providing fiber optic cables to each building with one fiber-optic cable coming from the Alpha Data Center and the other fiber optic cable from the Omega Data center. The Alpha Data Center is where the campus core data switches are located.

The Campus has two Minimum Points of Entry (MPOE) from AT&T. The Primary MPOE is located in the Administration Building adjacent to the Omega Data Center which feeds fiber and copper pairs from an AT&T manhole along Fulton Ave. The primary MPOE is where the UI project fed the buildings with new copper pair cables. There is an NEC PBX switch located in the Administration MPOE for all analog lines. The secondary MPOE is located in the Maintenance & Operations Building BDF which feeds fiber and copper from an AT&T pullbox along Ethel Ave. The secondary MPOE is not currently utilizing any copper pairs for the campus.

CATV is currently not being utilized on campus. The CATV Head-End was originally located in the old Library but has since been demolished to prepare the site for the new Library and Academic Resource Center Building.

### 6.2 METHODOLOGY

Los Angeles Valley College utilizes a utility tunnel system to distribute the fiber and copper cables to the buildings. The Alpha and Omega Data Centers provide a redundant fiber backbone to the buildings on campus with each building receiving (2) 24 single-mode/24 multi-mode fiber optic cables—one cable from each data center. Each building also receives a separate fiber cable of 4 or 6 multimode fibers dedicated to the Campus fire alarm system. The fire alarm multimode fibers form a continuous full duplex loop topology with the main fire alarm panels located in the M&O and Central Plant buildings. The data centers are connected with (2) 72 single-mode/72 multi-mode fiber optic cables.

The non-switched voice network, analog lines, feed from the Administration Building MPOE from an NEC PBX switch. A majority of the buildings receive 50 copper pairs with a few select buildings receiving 100 or 200 copper pairs based on the requirements of the

College Information Systems Department. The copper cables are spliced, tapered, and encased throughout the East and West tunnel system. A majority of the campus is VoIP (voice over internet protocol) ready and the college is currently in the process of a campus conversion.

There are existing hard-line coax cables throughout both the East and West Tunnels connected with a series of repeaters for a CATV Distribution System. There is no CATV Head-End currently on campus due to the demolition of the old Library. No CATV service is in use at this time.

### 6.3 ANALYSIS OF EXISTING SYSTEM

With the UI project complete, the College took major steps in improving the Technology Infrastructure for the campus. The college has created a redundant fiber backbone network to most of the buildings on campus with (2) 24 single-mode/24 multi-mode fiber-optic cables feeding from both data centers and an additional (1) 4/6 fiber optic cable for fire alarm and security. Along with the fiber a minimum of 50 pair copper was also provided to the buildings from the primary MPOE. To be a truly redundant network the College may consider extending the copper from the secondary MPOE and run service to the Campus Center Data Center and feed all buildings with an additional 25 pair copper cables.

There still appears to be some copper terminations that need to be completed in some of the west and east tunnel pull-boxes. The west pullbox#3 (WPB#3) has copper cable coiled, not terminated and labeled for the Theater Arts Building. The east pullbox#11 (EPB#11) has (3) 50 pair cables that are coiled not terminated, and labeled for the Behavioral Sciences, Life Science, and Humanities Buildings.

The Omega Data Center currently does not have the sufficient space planning in order to accommodate the continued future growth of the campus. The Omega Data Center ceiling tiles display signs of water intrusion and proper fire-stopping techniques for wall/floor/ceiling penetrations should be implemented. The ceilings of the primary MPOE are deteriorating at a rapid pace which appears to be due to water intrusion. The primary MPOE also needs to be renovated to remove old non-functional equipment. Both the Omega Data Center and MPOE need to initiate cable management techniques for copper and fiber data cables and vertical wall mounted power distribution units. The Omega Data Center does currently meet the LACCD IT Design Standards September 2009, Districtwide Data Center Design Std 03-0909.

The Campus Center Data Center has sufficient space planning to accommodate future growth. The grounding bus bar for the Campus Center Data Center should be connected to a minimum 3/0 AWG ground wire to the main building ground—this does not seem apparent at this time unless the data center is utilizing a signal reference grid as stated in the LACCD Datacenter Design Standards. Future growth will require additional conduits from the tunnel distribution system.

### 6.4 ANALYSIS OF FUTURE NEEDS

We recommend the steps the College has taken in establishing a redundant network by utilizing both the Alpha and Omega Data Centers

to dual feed the buildings on campus. The College may consider utilizing the copper service from the secondary MPOE into the Campus Center for a redundant copper network to serve the buildings on campus. They will also need to expand fiber and copper cables to the new and existing buildings East of Ethel Ave. to provide redundant services to that portion of campus.

The Measure J Master Plan currently calls for the demolition of the current Administration Building which houses the Omega Data Center and Primary MPOE. Prior to demolition, the College will need to relocate temporarily or permanently the Omega Data Center in order to maintain a redundant network on campus.

### 6.5 FINDINGS AND RECOMMENDATIONS

The recommendations have been categorized into three priority levels. Descriptions of each priority level are provided in the executive summary of this report.

#### Priority 1 - Omega Data Center and MPOE Relocation

The College will need to establish a temporary and/or permanent data center and MPOE prior to the demolition of the Administration Building if they wish to continue to have a redundant network on campus. The following are three possible options the College may consider:

#### Option 1: New Data Center and MPOE

A new Data Center will need to be built out prior to the demolition of the existing Administration Building in order for the College to continue with redundant service on campus. A new primary MPOE must be established prior to the demolition of the Administration Building in order to maintain the analog copper lines currently in service to all buildings.

We recommend that a new Data Center and MPOE be established as its own separate independent building with access to the West Tunnel. The minimum size of this building shall be no smaller than 20'x20' to accommodate all MPOE and Data Center connections. We propose the new location of this building to be located north of the new Library where the existing Theater Arts Building is proposed for demolition. This type of independent MPOE/Data Center Building would be similar to what California State University, Long Beach has implemented on their respective campus.

We propose that a tie cable be established between the Omega Data Center and the New Data Center while services are being transferred to the new location. It is also possible to maintain a majority of the existing 24 single-mode/24multi-mode fiber cables recently installed under the UI project by fusion splicing new fiber cables to the existing Omega Data Center fiber cables and encasing them in the tunnel. Both Data Centers will be connected via fiber and copper cable. Additional conduits will need to be added between the new Data Center and the existing Omega Data Center to manage the increase in fiber cables to be routed between them.

Coordination with AT&T will be required to relocate the copper and fiber MPOE feeds and may take several months to complete depending on AT&T's schedule to move such services.

Any new permanent data center shall comply to the latest LACCD IT Design Standards--Districtwide Data Center Design Standard.

Option 2: Combine Omega Data Center and MPOE temporarily in the Campus Center Data Center

Combining the Omega Data Center copper and fiber feeds within the existing Campus Center Data Center is an option the campus may wish to consider if building a separate new Data Center and MPOE building is prohibitive. The College can also use this option temporarily while a decision can be made to build a new permanent data center in the new Administration building or other location.

This option would concentrate all network equipment and voice equipment into one location. Coordination would still be required with AT&T to extend copper and fiber service into the Campus Center Building. The Campus Center is large enough to accommodate the additional racks needed for network and connectivity equipment and reconfiguration of the wall space would allow 110 wall terminals and protectors to service the copper analog pairs.

This option would require a minimum of 6 4" underground conduits to connect the west and east tunnels in order to deliver service and to maintain active dual fiber feeds to the buildings.

Concentrating all of this equipment in the Campus Center will require an electrical study to determine if appropriate power is available and consideration will need to be given to additional cooling capacity if required.

Option 3: Relocate Data Center and MPOE into LRC Building

The LRC Building is currently under construction and consideration is being given to relocate the new Data Center and MPOE into the new building BDF if space and construction schedule permits.

This area was the original location of the campus MPOE and some existing conduits from an AT&T pullbox to this area may remain in place. The College has provisioned for new conduits from the AT&T pullbox to the new building BDF.

This option would require architect and general contractor coordination in order to enlarge the BDF room if required and plan for additional conduit infrastructure to feed the building from the tunnel vault system. Additional electrical and mechanical coordination would likely be required since this BDF was not likely sized for the power and cooling requirements a data center requires.

The College can also use this option temporarily while a decision can be made to build a new permanent data center in the new Administration building or other location.

Copper Cables

*Priority 1* - We recommend that the copper cables from the secondary MPOE in the Maintenance and Operations Building be extended into the Alpha Data Center to provide a minimum of 25 copper pairs run to each building before the primary MPOE is demolished if a new and/or temporary data center/MPOE has not been established. 25 Additional copper pairs may be run to each building if copper redundancy is needed.

*Priority 1* - The primary MPOE can be re-established at the new data center/MPOE location where a minimum of 50 pair copper cable is run to most buildings on campus. All new buildings could be fed with a minimum (1) 25 pair copper cable from the MPOE VoIP established buildings.

Fiber Cables

*Priority 2* - We continue to recommend the College's direction to dual feed each building with fiber cables to each building from both Data Centers. Larger buildings such as the new Library, Administration/CWCD, Media Art Center, Performance Art Center, and Multi-Purpose PE/Community Services Center should continue to receive 24 single-mode/24 multi-mode fiber. For smaller buildings such as the Athletic Training Facility Buildings, 12 single-mode/12 multimode fiber cables are recommended.

*Priority 1* - We recommend the College continue to run (1) 6 fiber multimode cable to each building to accommodate the dedicated fire alarm loop system. The older 4 fiber multimode cable should be replaced with (1) 6 fiber multimode cable of the same class. It is also recommended that the fire alarm fiber optic cable be run in a dedicated 2" conduit in order to prevent any potential objections from the local Authority Having Jurisdiction (AHJ) on running fire alarm cable and network fiber cable within the same conduit. A separate fiber in a separate conduit should satisfy National Fire Alarm Code (NFPA 72®).

Conduits

*Priority 3* - Under the UI project most buildings received (2) 4" conduits into the BDF from the Tunnel/Pull-box system. We recommend that all future building receive a minimum (3) 4" conduits into each BDF if existing tunnel conditions may support it.

*Priority 1* - In order to serve the buildings East of Ethel Ave. a minimum of (6) 4" conduits shall exit from the South Gym Vault wall and cross Ethel Ave to provide fiber and copper services to the new proposed buildings. A system of pull-boxes/manholes will intercept these conduits in order to prevent no more than two 90 degree bends in each section of conduit.

*Priority 2* - We recommend that the west and east tunnel sections between the Administration Building and the Campus Center Building be connected with a minimum of (6) 4" conduits in order to facilitate and shorten the backbone fiber lengths run to reach building.

*Priority 2* - We recommend that an additional (4) 4" conduits extend out from the Campus Center Building and/or tunnel area to feed the existing manhole located in the center of the North Gym, CSIT, Financial Aid, and Project Manager Buildings. This would provide the North Gym and new proposed Buildings a more direct connection to the Data Centers.

Telecommunication Spaces

*Priority 1* - We recommend the upgrade of all telecom rooms to incorporate proper cabling management techniques, Ground and Bonding to meet ANSI/EIA/TIA 607 Standards, and properly implemented fire-stopping systems.

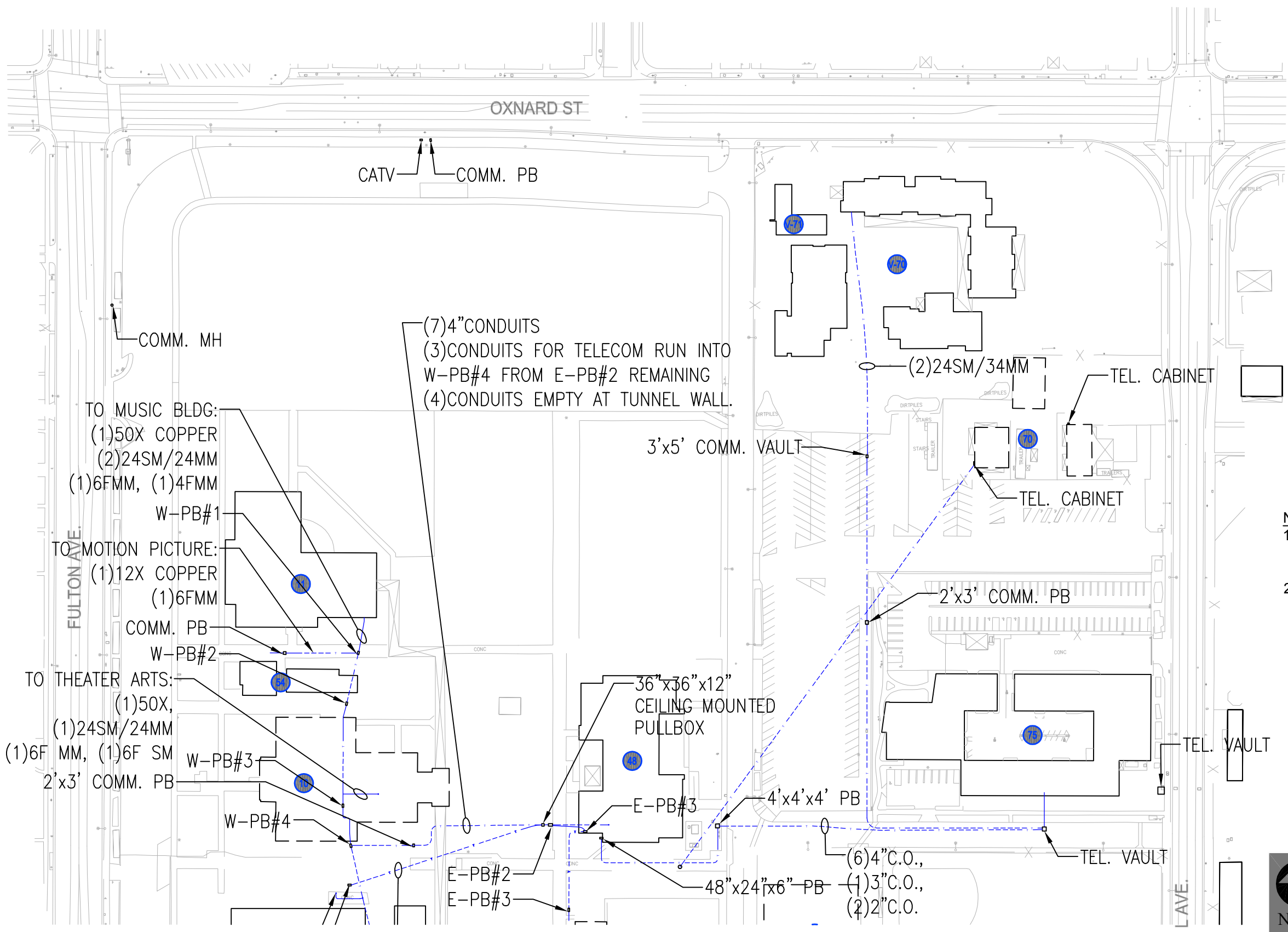
*Priority 2* - We recommend to make the Alpha Data Center the CATV Head-End if the College decides to renew service with Time Warner or implement an IP TV service. It is our recommendation to have video distributed over the single-mode fiber from the new fiber infrastructure.

Abandoned Infrastructure Systems

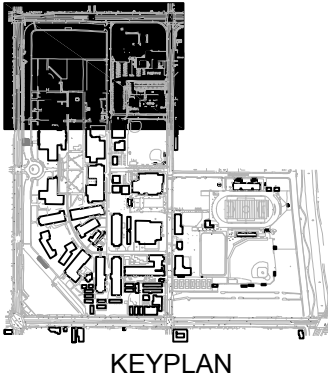
Priority 3 - There are non-functional legacy infrastructure systems that reside in the tunnel that are no longer in use. If additional space is needed to run new conduit systems for MEPT services then the campus may wish to remove some of these older legacy systems.

Site

*Priority 2* - We recommend that the College consider implementing a Wide-Area Emergency Broadcast System (WEBS) of towers and wall phones in strategic areas on campus with the coordination of campus public safety. Implementing a WEBS system would provide notification to the campus community of a confirmed emergency or immediate threat to the health and safety of students and educators on campus. Implementing such a system will also help satisfy the requirements of the US Department of Education requirement for an emergency notification policy for dealing with campus emergencies.



**LEGEND:**  
 EXISTING BUILDING  
 EXISTING TELE. LINE

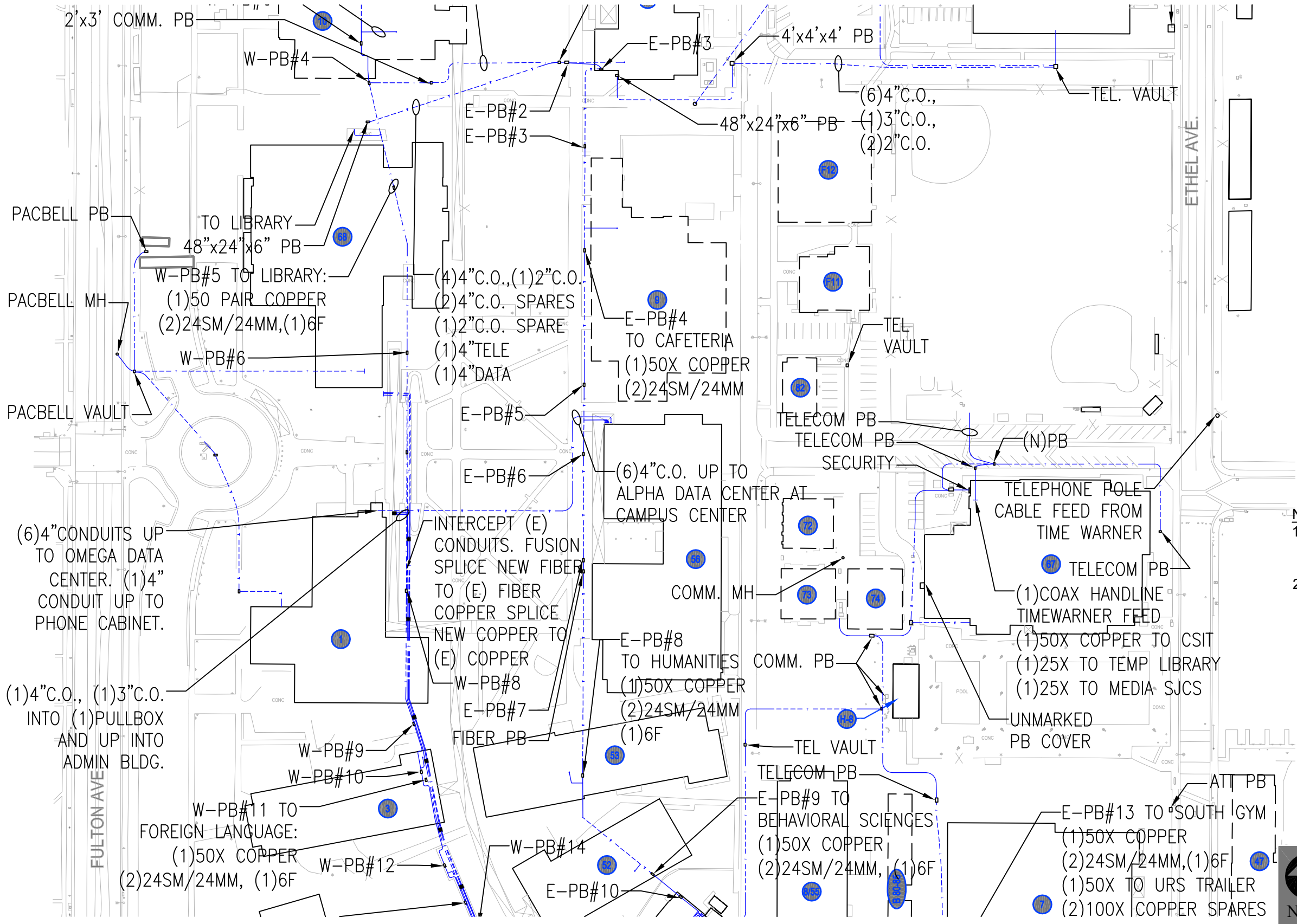




**NOTE:**  
 1. REFER TO TABLES ES-1 AND ES-2 FOR BUILDING NAMES.  
 2. THE INFORMATION SHOWN HEREON IS A GRAPHICAL DEPICTION OF THE EXISTING CAMPUS UTILITY SYSTEMS. THE SITE SURVEY AND INFRASTRUCTURE STUDIES EXISTING UTILITY PLANS PREPARED UNDER SEPARATE COVER SHALL BE REFERENCED FOR DETAILED INFORMATION

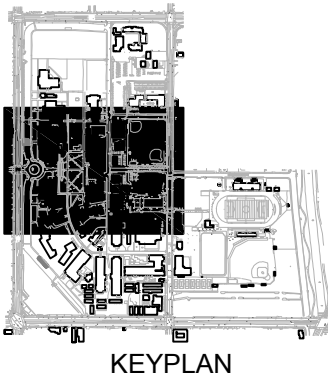


FIGURE 6a  
 EXISTING CONDITIONS UTILITY MAP - TELECOMMUNICATIONS

*(Page Intentionally Left Blank)*



**LEGEND:**  
 EXISTING BUILDING  
 EXISTING TELE. LINE

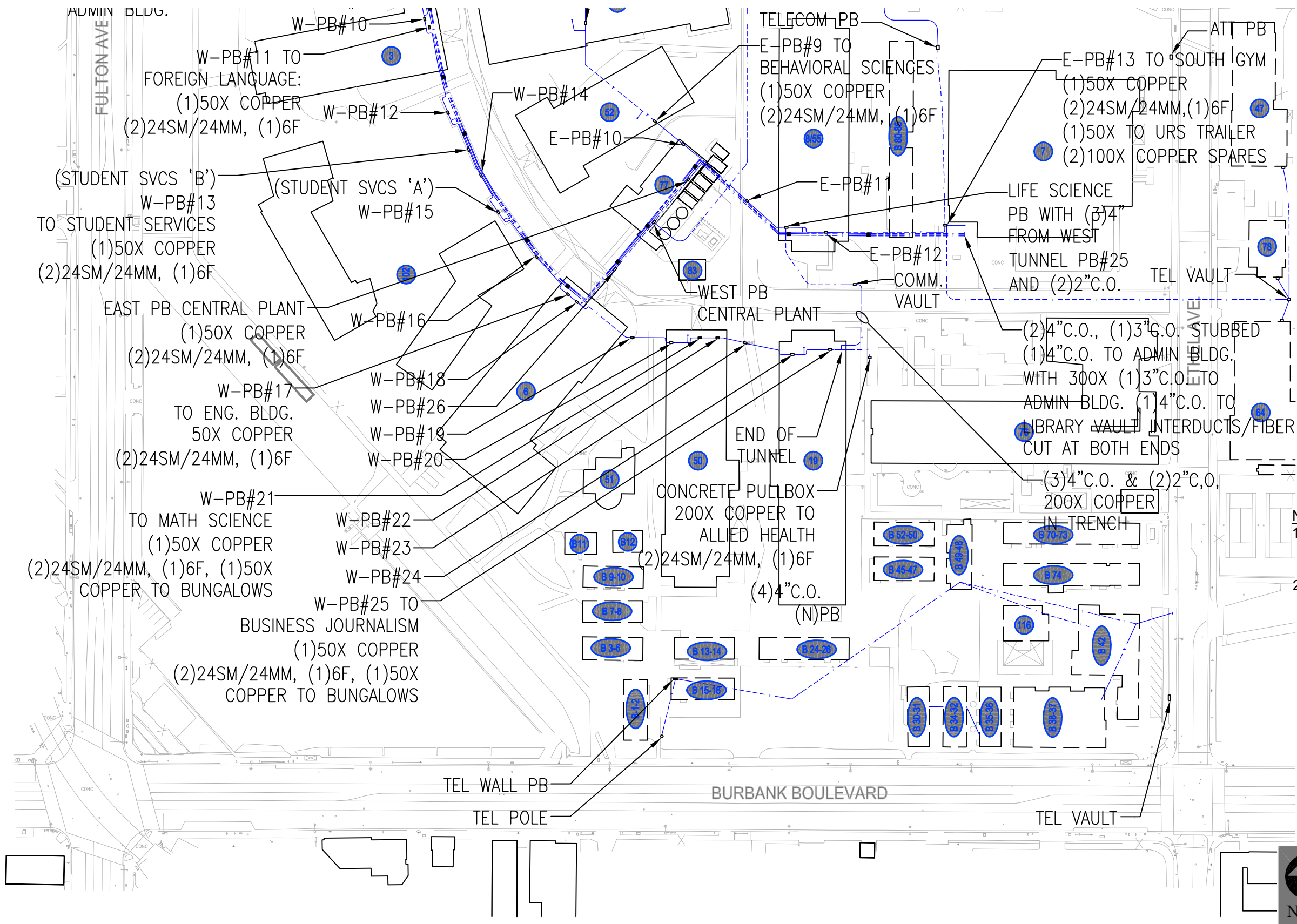


**NOTE:**  
 1. REFER TO TABLES ES-1 AND ES-2 FOR BUILDING NAMES.  
 2. THE INFORMATION SHOWN HEREON IS A GRAPHICAL DEPICTION OF THE EXISTING CAMPUS UTILITY SYSTEMS. THE SITE SURVEY AND INFRASTRUCTURE STUDIES EXISTING UTILITY PLANS PREPARED UNDER SEPARATE COVER SHALL BE REFERENCED FOR DETAILED INFORMATION



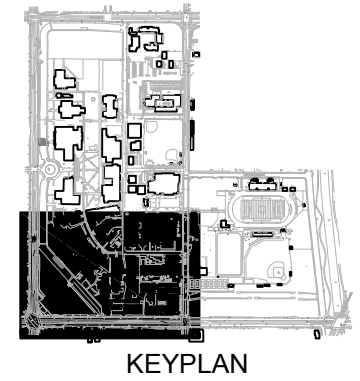
FIGURE 6b  
 EXISTING CONDITIONS UTILITY MAP - TELECOMMUNICATIONS

*(Page Intentionally Left Blank)*



**LEGEND:**

- EXISTING BUILDING
- - - EXISTING TELE. LINE

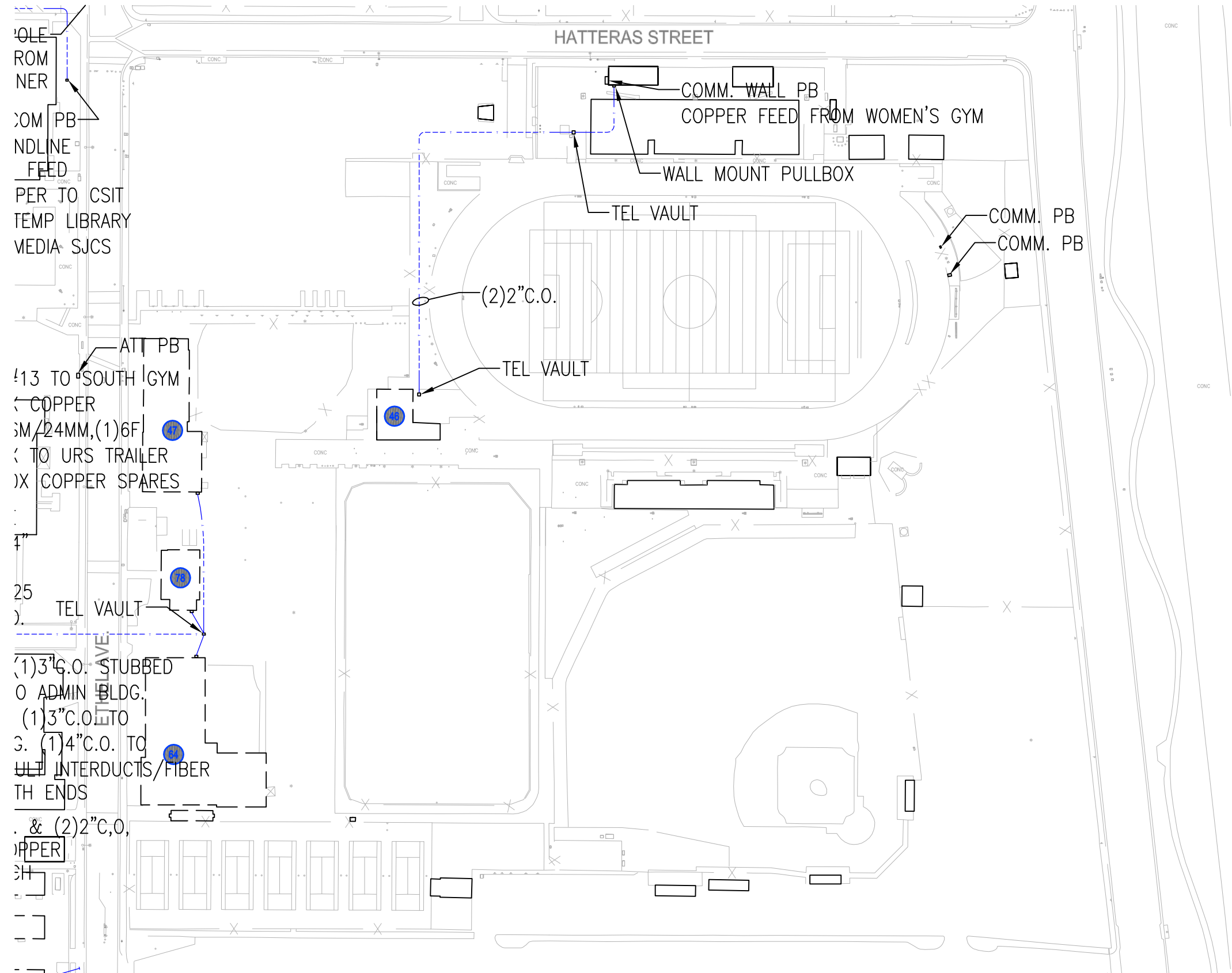




- NOTE:**
1. REFER TO TABLES ES-1 AND ES-2 FOR BUILDING NAMES.
  2. THE INFORMATION SHOWN HEREON IS A GRAPHICAL DEPICTION OF THE EXISTING CAMPUS UTILITY SYSTEMS. THE SITE SURVEY AND INFRASTRUCTURE STUDIES EXISTING UTILITY PLANS PREPARED UNDER SEPARATE COVER SHALL BE REFERENCED FOR DETAILED INFORMATION

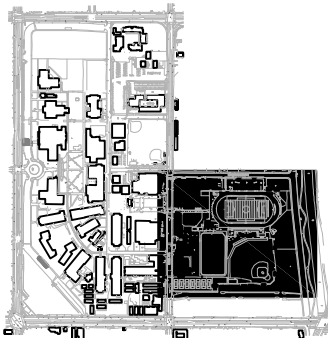


FIGURE 6c  
 EXISTING CONDITIONS UTILITY MAP - TELECOMMUNICATIONS

*(Page Intentionally Left Blank)*



**LEGEND:**  
 EXISTING BUILDING  
 EXISTING TELE. LINE



KEYPLAN





**NOTE:**  
 1. REFER TO TABLES ES-1 AND ES-2 FOR BUILDING NAMES.  
 2. THE INFORMATION SHOWN HEREON IS A GRAPHICAL DEPICTION OF THE EXISTING CAMPUS UTILITY SYSTEMS. THE SITE SURVEY AND INFRASTRUCTURE STUDIES EXISTING UTILITY PLANS PREPARED UNDER SEPARATE COVER SHALL BE REFERENCED FOR DETAILED INFORMATION

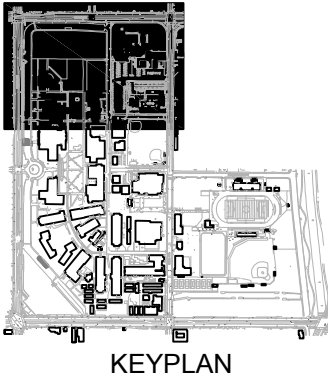


FIGURE 6d  
 EXISTING CONDITIONS UTILITY MAP - TELECOMMUNICATIONS

*(Page Intentionally Left Blank)*

**LEGEND:**

-  EXISTING BUILDING
-  PROPOSED MEASURE J BUILDING
-  EXISTING TELE. LINE
-  PROPOSED TELE. LINE



**NOTE:**

1. REFER TO TABLES ES-1 AND ES-2 FOR BUILDING NAMES.
2. THE INFORMATION SHOWN HEREON IS A GRAPHICAL DEPICTION OF THE EXISTING CAMPUS UTILITY SYSTEMS. THE SITE SURVEY AND INFRASTRUCTURE STUDIES EXISTING UTILITY PLANS PREPARED UNDER SEPARATE COVER SHALL BE REFERENCED FOR DETAILED INFORMATION
3. FUTURE CONDITIONS UTILITY MAPS SHOW ONLY THE DISPOSITION OF FUTURE BUILDINGS. REFER TO FIGURE 0e-MEASURE J MASTER PLAN SUMMARY FOR COMPLETE LAYOUT OF FUTURE CONDITIONS.

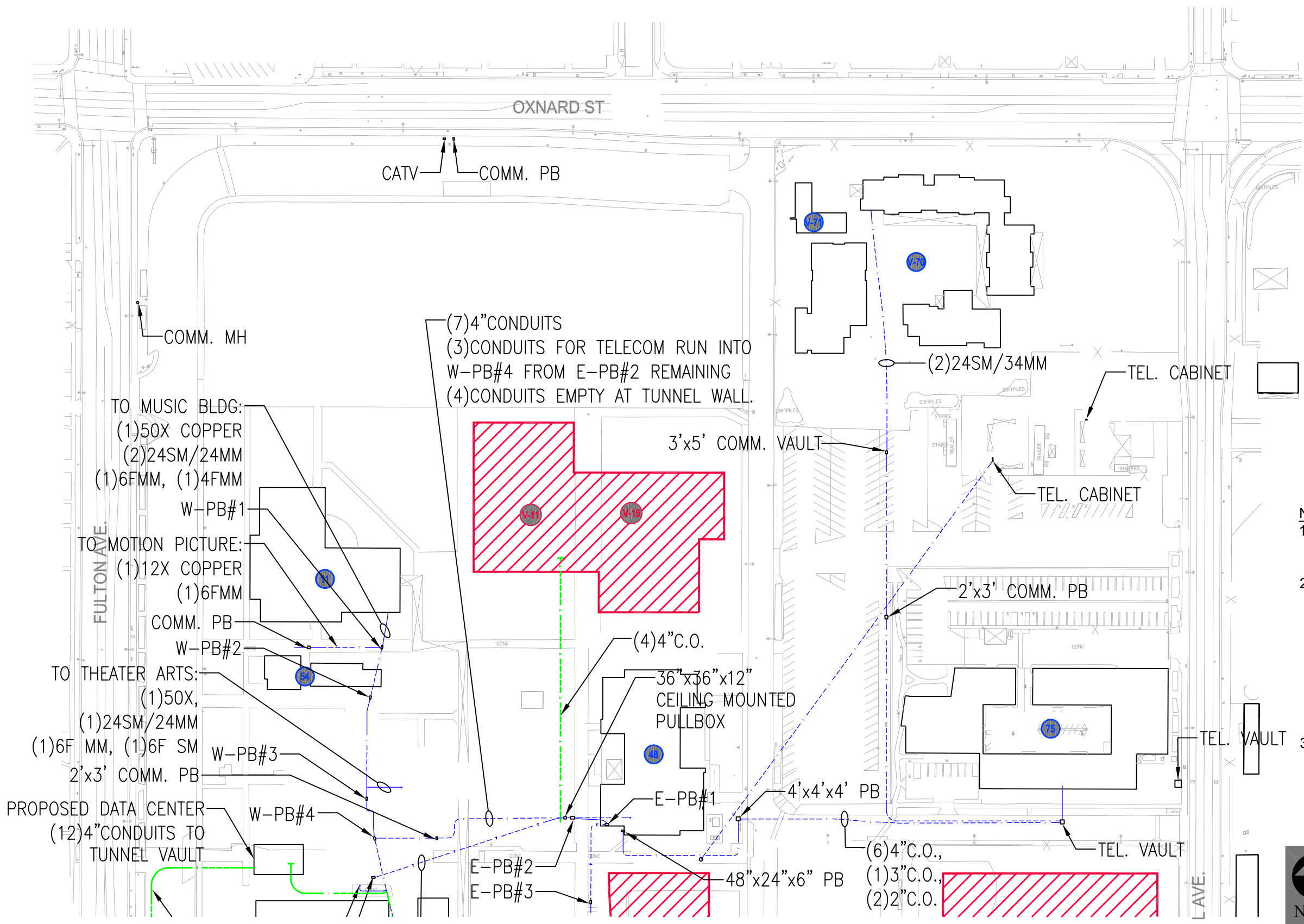
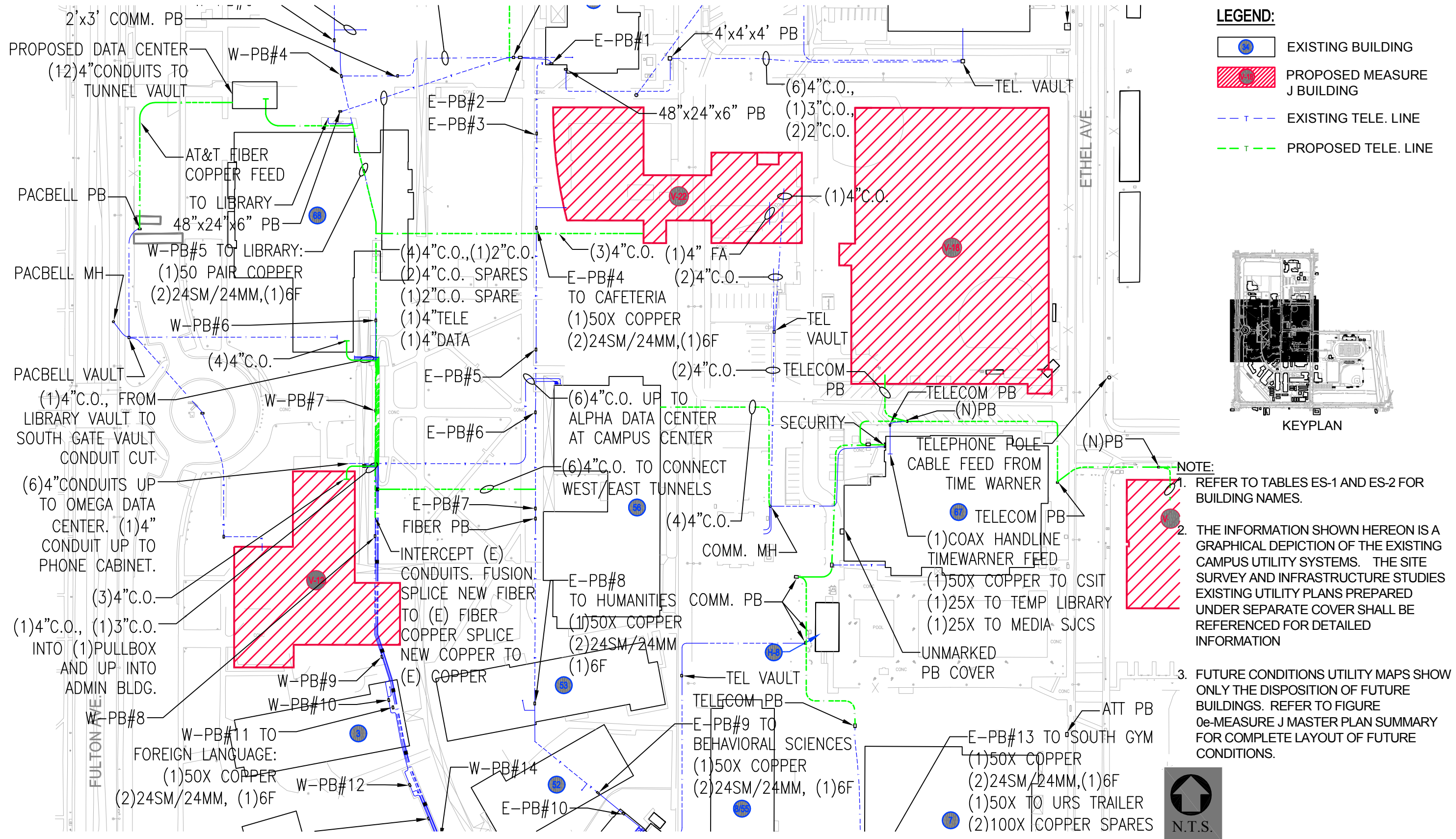


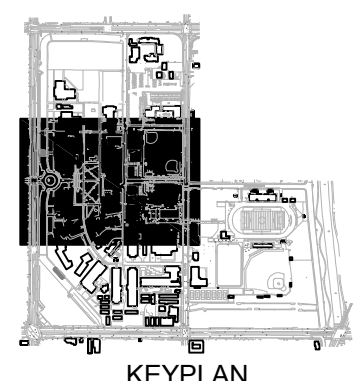
FIGURE 6e  
 FUTURE CONDITIONS UTILITY MAP - TELECOMMUNICATIONS

*(Page Intentionally Left Blank)*



**LEGEND:**

- EXISTING BUILDING
- PROPOSED MEASURE J BUILDING
- EXISTING TELE. LINE
- PROPOSED TELE. LINE

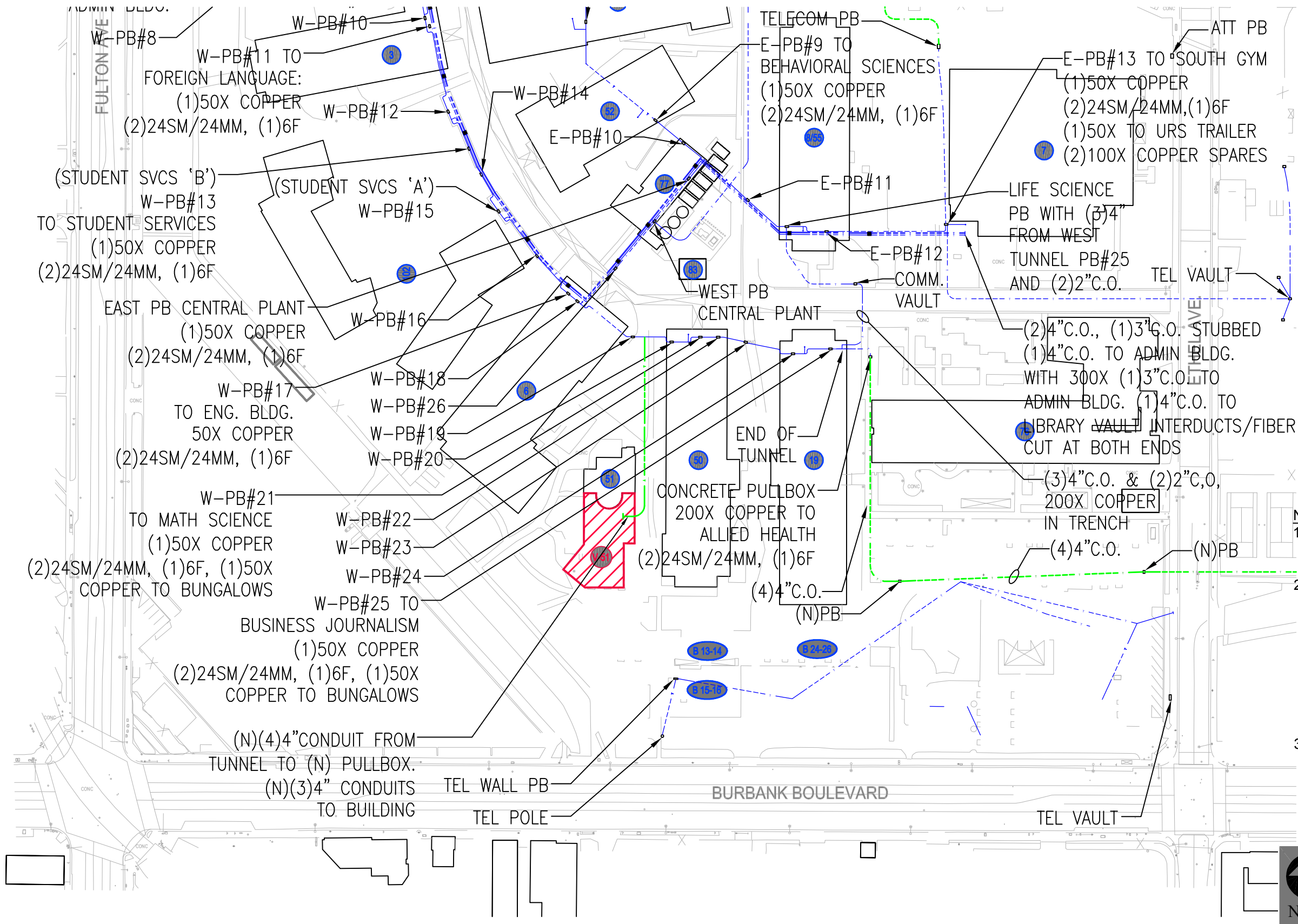


- NOTE:**
1. REFER TO TABLES ES-1 AND ES-2 FOR BUILDING NAMES.
  2. THE INFORMATION SHOWN HEREON IS A GRAPHICAL DEPICTION OF THE EXISTING CAMPUS UTILITY SYSTEMS. THE SITE SURVEY AND INFRASTRUCTURE STUDIES EXISTING UTILITY PLANS PREPARED UNDER SEPARATE COVER SHALL BE REFERENCED FOR DETAILED INFORMATION
  3. FUTURE CONDITIONS UTILITY MAPS SHOW ONLY THE DISPOSITION OF FUTURE BUILDINGS. REFER TO FIGURE 0e-MEASURE J MASTER PLAN SUMMARY FOR COMPLETE LAYOUT OF FUTURE CONDITIONS.



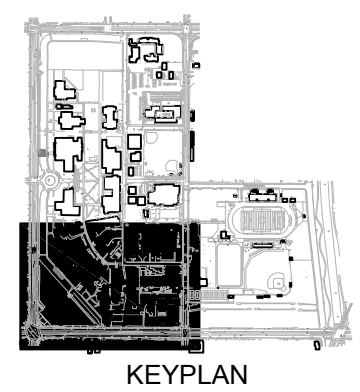
FIGURE 6f  
 FUTURE CONDITIONS UTILITY MAP - TELECOMMUNICATIONS

*(Page Intentionally Left Blank)*



**LEGEND:**

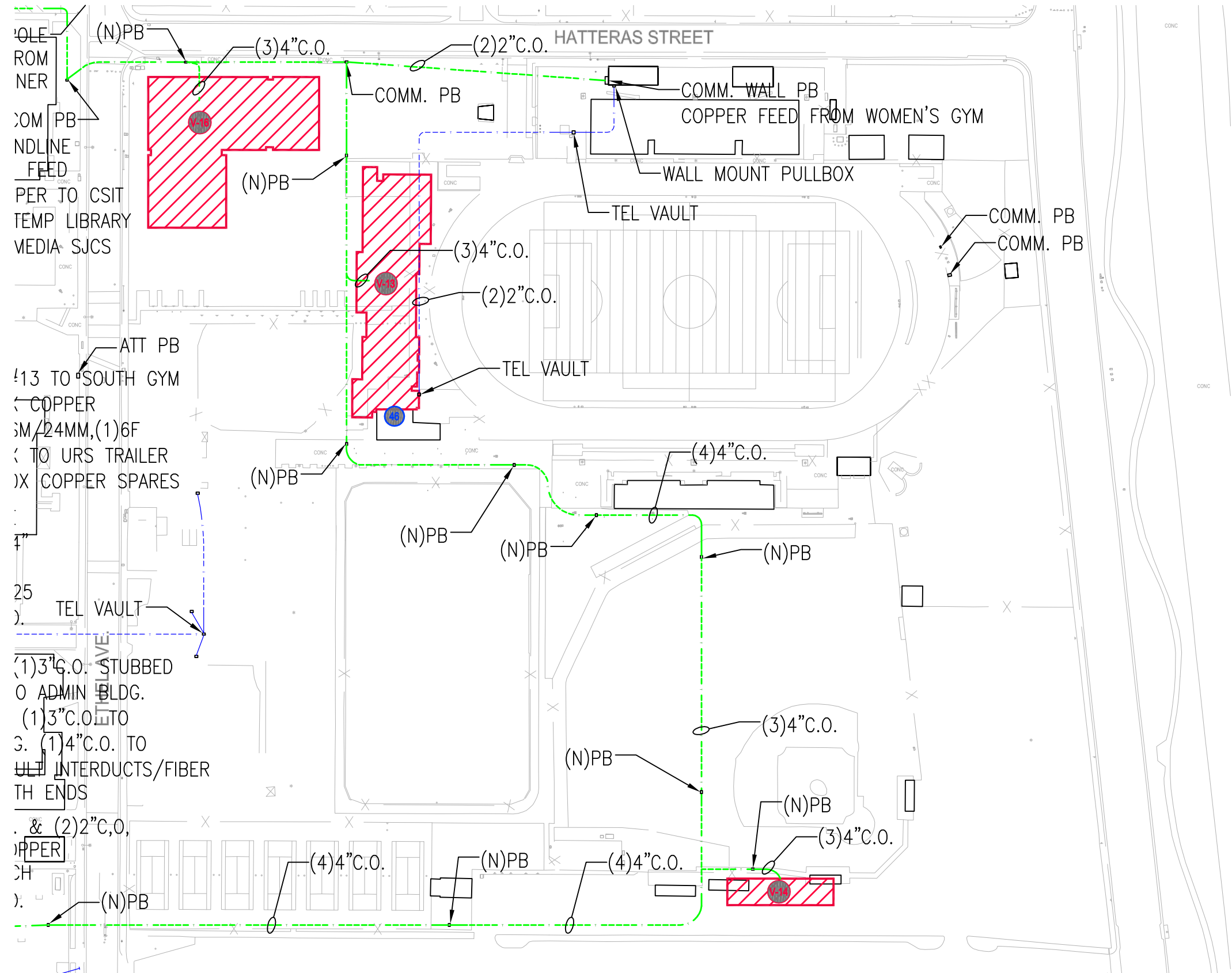
- EXISTING BUILDING
- PROPOSED MEASURE J BUILDING
- EXISTING TELE. LINE
- PROPOSED TELE. LINE







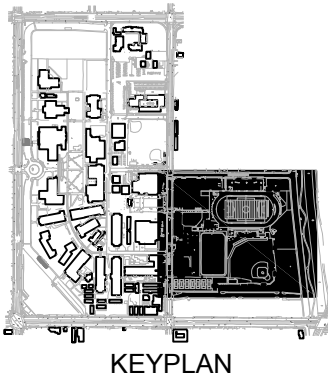
- NOTE:**
1. REFER TO TABLES ES-1 AND ES-2 FOR BUILDING NAMES.
  2. THE INFORMATION SHOWN HEREON IS A GRAPHICAL DEPICTION OF THE EXISTING CAMPUS UTILITY SYSTEMS. THE SITE SURVEY AND INFRASTRUCTURE STUDIES EXISTING UTILITY PLANS PREPARED UNDER SEPARATE COVER SHALL BE REFERENCED FOR DETAILED INFORMATION
  3. FUTURE CONDITIONS UTILITY MAPS SHOW ONLY THE DISPOSITION OF FUTURE BUILDINGS. REFER TO FIGURE 0e-MEASURE J MASTER PLAN SUMMARY FOR COMPLETE LAYOUT OF FUTURE CONDITIONS.

FIGURE 6g  
 FUTURE CONDITIONS UTILITY MAP - TELECOMMUNICATIONS

*(Page Intentionally Left Blank)*



- LEGEND:**
-  EXISTING BUILDING
  -  PROPOSED MEASURE J BUILDING
  -  EXISTING TELE. LINE
  -  PROPOSED TELE. LINE



- NOTE:**
1. REFER TO TABLES ES-1 AND ES-2 FOR BUILDING NAMES.
  2. THE INFORMATION SHOWN HEREON IS A GRAPHICAL DEPICTION OF THE EXISTING CAMPUS UTILITY SYSTEMS. THE SITE SURVEY AND INFRASTRUCTURE STUDIES EXISTING UTILITY PLANS PREPARED UNDER SEPARATE COVER SHALL BE REFERENCED FOR DETAILED INFORMATION
  3. FUTURE CONDITIONS UTILITY MAPS SHOW ONLY THE DISPOSITION OF FUTURE BUILDINGS. REFER TO FIGURE 0e-MEASURE J MASTER PLAN SUMMARY FOR COMPLETE LAYOUT OF FUTURE CONDITIONS.



FIGURE 6h  
 FUTURE CONDITIONS UTILITY MAP - TELECOMMUNICATIONS

*(Page Intentionally Left Blank)*

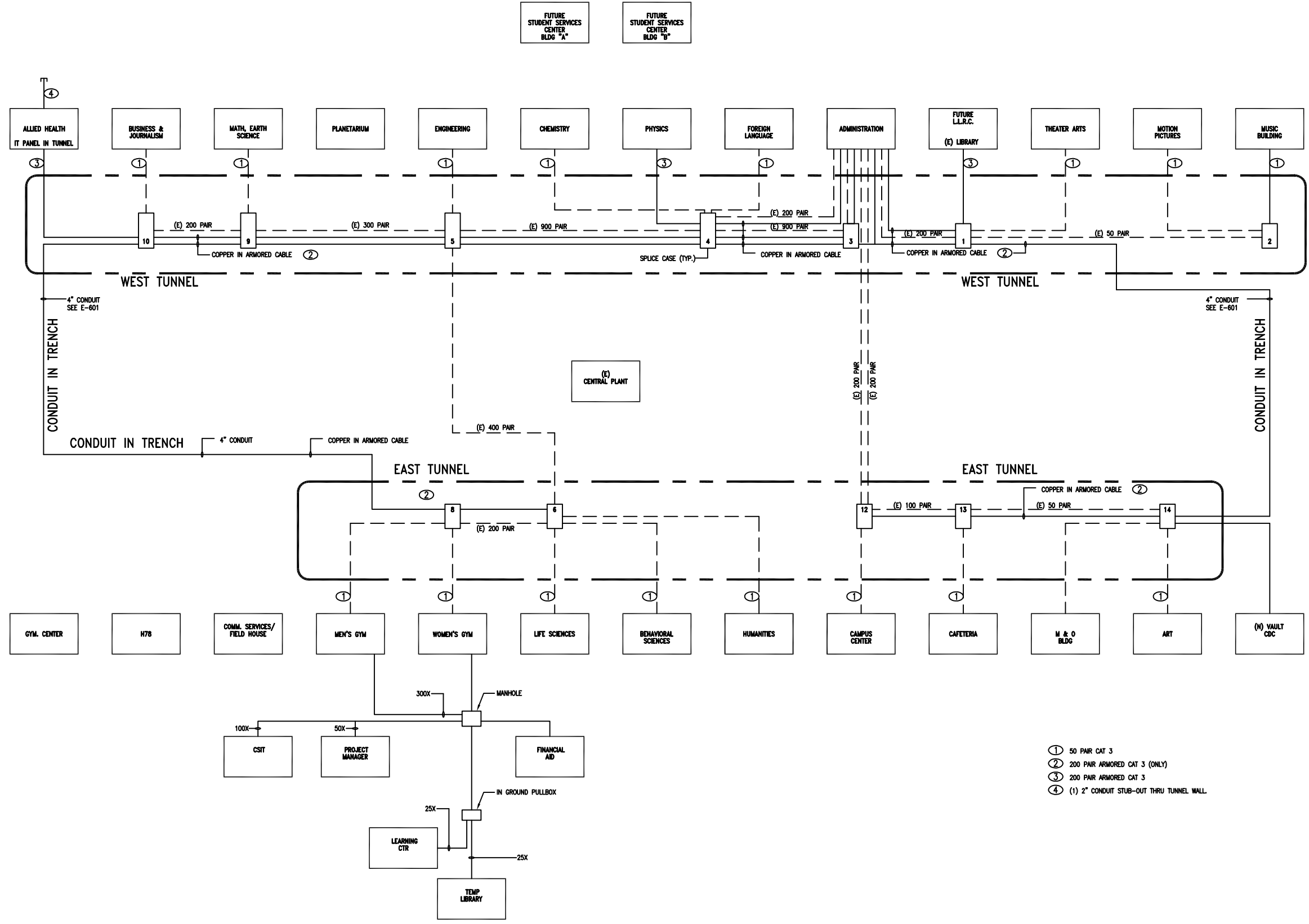
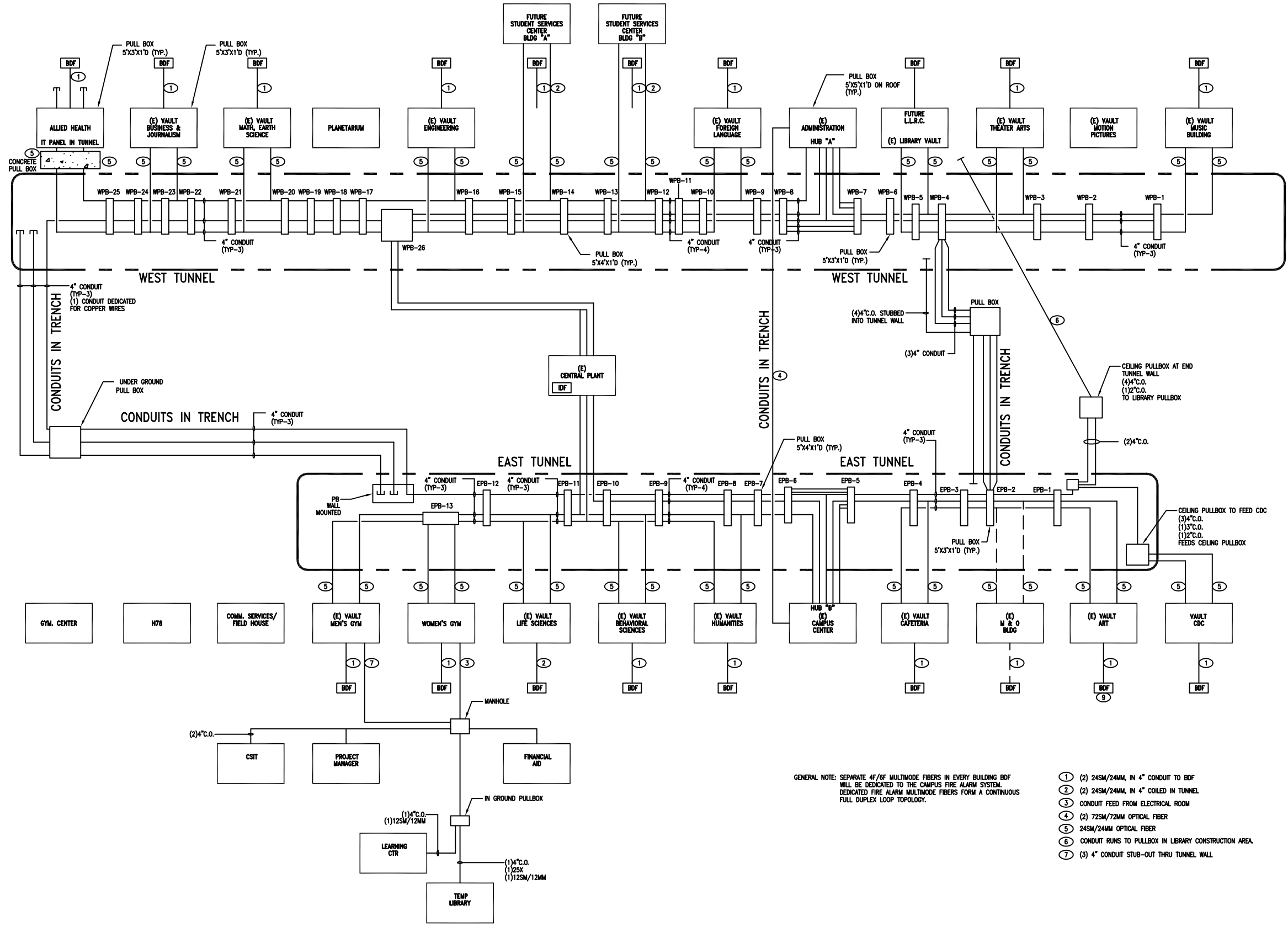


FIGURE 6j  
 FUTURE CONDITIONS UTILITY MAP - COPPER WIRING DIAGRAM

*(Page Intentionally Left Blank)*



GENERAL NOTE: SEPARATE 4F/8F MULTIMODE FIBERS IN EVERY BUILDING BDF WILL BE DEDICATED TO THE CAMPUS FIRE ALARM SYSTEM. DEDICATED FIRE ALARM MULTIMODE FIBERS FORM A CONTINUOUS FULL DUPLEX LOOP TOPOLOGY.

- ① (2) 24SM/24MM, IN 4" CONDUIT TO BDF
- ② (2) 24SM/24MM, IN 4" COILED IN TUNNEL
- ③ CONDUIT FEED FROM ELECTRICAL ROOM
- ④ (2) 72SM/72MM OPTICAL FIBER
- ⑤ 24SM/24MM OPTICAL FIBER
- ⑥ CONDUIT RUNS TO PULLBOX IN LIBRARY CONSTRUCTION AREA
- ⑦ (3) 4" CONDUIT STUB-OUT THRU TUNNEL WALL

FIGURE 6k  
 FUTURE CONDITIONS UTILITY MAP - INFRASTRUCTURE FIBER/CONDUIT DIAGRAM

*(Page Intentionally Left Blank)*

## SECTION 7 – NATURAL GAS SYSTEM

### 7.1 SYSTEM DESCRIPTION

The Los Angeles Valley College (LAVC) Measure J Natural Gas System Utility Master Plan section consists of evaluating the existing flow capacity available at the meters, the impact of the proposed facilities on the capacity of existing gas distribution system, identifying the required modifications/upgrades to the existing gas distribution system to support the future build out of the campus and to analyze the existing supply distribution for buried gas lines that will be in conflict with the proposed facilities that will require relocation.

### 7.2 METHODOLOGY

The following methodology was adopted in formulating our Natural Gas utility infrastructure master plan. The methodology presented below outlines the critical tasks that were performed in development of this master plan report.

- A critical aspect in the evaluation of the existing Natural Gas system serving a facility is a detailed and accurate field investigation of the current system. Meetings and discussions with the campus helped gather existing information and any potential problems faced with the system. A detailed survey of the existing Gas system that currently serve the facilities at Los Angeles Valley College campus was undertaken, and existing conditions, together with potential problems, were identified. The surveyed information was verified through available record drawings and meetings with the campus facilities staff.
- A load flow study of the existing and future loads was developed and existing and proposed capacity requirements were developed. A BTUH/sqft of proposed and existing facilities was assumed in our load studies. For some existing buildings where this information was available, existing installed capacities of the gas fired equipment were taken to estimate the total loads.

- The Natural Gas system was then evaluated for capacity, functionality, reliability, ease of maintenance, age, and its ability to serve the present and future needs of the campus
- Alterations/upgrade/modifications necessary to support new buildings, major renovations, and building retrofits that form part of the proposed campus facilities master plan were identified.
- Recommendations were developed to support new buildings, major renovations, and building retrofits that form part of the proposed campus facilities master plan were identified.
- Costs associated with each of the required utility upgrades were developed and the most cost effective solution was recommended.

### 7.3 ANALYSIS OF EXISTING SYSTEM

The Los Angeles Valley College campus is currently served from seven gas meters located in various locations. The first meter is located inside a chain linked fence enclosure outside of the Power/Central Plant which serves majority of the buildings on the campus along with a second meter that only supplies gas to the Power/Central plant, both deriving gas service from the cities 4" main line running along Campus Drive. The third gas meter is located on the South side of the campus serving the bungalows off Burbank Boulevard and deriving gas service from the cities 4" main line running along Burbank Boulevard. The fourth gas meter is located off Ethel Avenue, on the south side of the Gymnastic Center building serving the Field House, Drawing/Music bldg. and Gymnastic Center and derives gas service from the cities 3" main line running along Ethel Avenue. A fifth gas meter is located off Ethel Avenue, on the east side of the North Gym (Women's Gym) serving the Pool House and North Gym and derives gas service from the cities 3" main line running along Ethel Avenue. The sixth gas meter is located off Ethel Avenue, on the East side of the Sheriff and Maintenance Operations building serving only those buildings and also derives gas service from the cities 3" Main line running along Ethel Avenue. Lastly, the seventh gas meter is believed to be located on the north side of the campus, off Oxnard Street serving the Child Development and Family Resource Center. The exact location has not yet been confirmed.

Partial Site Plans 'Existing Utility Map - Natural Gas 7a - 7d' shows the existing natural gas distribution piping system throughout the campus.

Majority of the Campus gas infrastructure was installed in the 1950's and is in good standing condition. Natural Gas service is derived from Southern California Gas Company's medium pressure system. The distribution system throughout the campus has undergone extensions over the years to accommodate campus expansions and additions. A recent modification to the main gas distribution campus piping was undertaken leaving a lengthy portion abandoned in place and providing a single upsized main line to replace such lines. Discussions with the campus maintenance facilities staff revealed that Gas mains downstream of the gas meters are either P.E. plastic piping or black steel pipe ranging from 3/4 inch to 6-inches in diameter.

Natural Gas downstream of the meters are distributed at medium pressure at approximately 5 psig throughout the campus in most locations with the exception of the third meter located on the South side of the campus serving the bungalows off Burbank Boulevard and fourth meter located on the south side of the Gymnastic Center building. The medium-pressure gas is reduced to low-pressure gas at building connections via gas pressure regulators installed either above grade or in underground vaults. The low-pressure gas is then piped to serve hot water boilers that serve for Space Heating and water heaters that serve for domestic hot water needs to plumbing fixtures. Natural gas is used for domestic water heating and industrial hot water.

The total estimated combined gas load demand for the existing system served through all meters is approximately 68,500 MBH (thousand BTU's per hour). At 1,000 BTU per cubic-foot-per-hour (CFH) natural gas conversion factor, the required gas flow demand is 68,500 CFH.

The following Tables provide approximate Heating and Domestic connected load demands based on building square footage in absence of metered data in each building.

Table 7-1: Existing Gas Demand Loads

Meter 1

Bldg. No.	Building Name	Occupancy Type	Gross Area (Sq. Ft.)	Heating Load Factor (BTUH/sq.ft.)	Estimated Heating Load (CFH)	Estimated Domestic Load (CFH)	Total Gas Load (CFH)
01	Administration	Office	26,955	30	850	340	1,190
03	Foreign Language	Academic	16,130	35	595	300	895
06	Engineering	Academic	24,145	35	890	445	1,335
07	South Gym	Gymnasium	45,200	45	2,140	1,500	3,640
08	Life Science	Academic	20,660	35	760	380	1,140
09	Cafeteria	Retail	29,345	20	620	200	820
10	Theater Arts	Academic	21,963	35	810	405	1,215
11	Music	Academic	16,441	35	605	300	905
19	Business & Journalism	Academic	22,590	35	835	420	1,255
46	Ticket Off./Concessions	Retail	2,936	20	No gas service to this bldg.		-
48	Art	Academic	18,965	35	700	350	1,050
50	Math Science	Academic	19,611	35	725	360	1,085
51	Planetarium	Academic	2,616	35	No gas service to this bldg.		-
52	Behavioral Science	Academic	13,700	35	505	255	760
53	Humanities	Academic	19,400	35	715	360	1,075
54	Motion Pictures /TV Studio	Academic	4,700	35	175	90	265
55	Life Science Bldg. Storage	Warehouse	198	20	No gas service to this bldg.		-
56	Campus Center	Academic	83,553	35	3,080	1,540	4,620
68	Library/Academic Res. Ctr.(LARC)	Academic	92,922	35	3,425	1,710	5,135
72	Project Manager	Office	3,592	30	No gas service to this bldg.		-
73	Computer Science (CSIT)	Academic	3,600	35	No gas service to this bldg.		-
74	Financial Aid	Office	4,320	30	No gas service to this bldg.		-
76	Allied Health Science (AHS)	Academic	80,767	35	-	*1,050	1,050

82	Business Office	Office	2,709	30	No gas service to this bldg.		
83	Sidewalk Cafe	Retail	151	20	No gas service to this bldg.		-
102-1	Student Services Center	Academic	20,093	35	740	370	1,110
102-2	Student Services Center	Academic	20,093	35	740	370	1,110
B 80-85	Bungalows	Academic	6,464	35	240	120	360
<b>TOTALS</b>							<b>30,015</b>

Meter 2

Bldg. No.	Building Name	Occupancy Type	Gross Area (Sq. Ft.)	Heating Load Factor (BTUH/sq.ft.)	Estimated Heating Load (CFH)	Estimated Domestic Load (CFH)	Total Gas Load (CFH)
77	Central Power Plan	Industrial	5,694	N/A	*20,000	-	20,000
<b>TOTALS</b>							<b>20,000</b>

Meter 3

Bldg. No.	Building Name	Occupancy Type	Gross Area (Sq. Ft.)	Heating Load Factor (BTUH/sq.ft.)	Estimated Heating Load (CFH)		Estimated Domestic Load (CFH)
116	Coffee House	Retail	787	20	No gas service to this bldg.		-
F-11	Learning Center	Academic	13,532	35	No gas service to this bldg.		-
F-12	Temp. Library	Academic	6,001	35	No gas service to this bldg.		-
B 1-2	Bungalows	Academic	2,087	35	75	40	115
B 3-6	Bungalows	Office	2,014	30	65	30	95
B 7-8	Bungalows	Academic	1,906	35	70	35	105
B 9-10	Bungalows	Academic	1,873	35	70	35	105
B 11	Bungalow	Academic	999	35	35	30	65
B 12	Bungalow	Office	937	30	30	25	55
B 13-14	Bungalows	Academic	1,900	35	65	30	95
B 15	Bungalow	Academic	1,979	35	65	30	95
B 16	Historical Museum Bungalow	Academic	1,979	35	65	30	95

LOS ANGELES VALLEY COLLEGE – MEASURE J UTILITY MASTER PLAN  
 APRIL 26, 2010

B 24-26	Bungalows	Academic	2,866	35	105	50	155	
B 31-30	Bungalows	Academic	1,888	35	65	30	95	
B 32-34	Bungalows	Academic	2,047	35	65	30	95	
B 36-35	Bungalows	Academic	1,866	35	65	30	95	
B 37-38	Bungalows	Academic	7,855	35	290	145	435	
B 45-47	Reading Center Bungalows	Academic	2,055	35	65	30	95	
B 49-48	Bungalows	Academic	2,347	35	90	45	135	
B 50-52	Bungalows	Academic	2,072	35	65	30	95	
B 70	Family Resource Center bungalow	Academic	4,199	35	155	80	235	
B 71	Bungalow	Academic	4,199	35	155	80	235	
B 72-73	Bungalows	Academic	4,199	35	155	80	235	
B 74	Cooperative Ed. Bungalow	Academic	4,334	35	160	80	240	
B xx-xx	Bungalows	Academic	7,124	35	260	130	390	
<b>TOTALS</b>								<b>3,360</b>

Meter 4

Bldg. No.	Building Name	Occupancy Type	Gross Area (Sq. Ft.)	Heating Load Factor (BTUH/sq.ft.)	Estimated Heating Load (CFH)	Estimated Domestic Load (CFH)	Total Gas Load (CFH)	
47	Field House	Gymnasium	9,764	45	460	320	780	
64	Gymnastic Center	Gymnasium	18,700	45	885	620	1,505	
78	Drawing/Music	Academic	2,807	35	105	55	160	
<b>TOTALS</b>								<b>2,445</b>

Meter 5

Bldg. No.	Building Name	Occupancy Type	Gross Area (Sq. Ft.)	Heating Load Factor (BTUH/sq.ft.)	Estimated Heating Load (CFH)	Estimated Domestic Load (CFH)	Total Gas Load (CFH)
67	North Gym	Gymnasium	37,963	45	1,800	1,260	3,060
	Pool House	Pool	-	N/A	-	*5,660	5,660
<b>TOTALS</b>							<b>8,720</b>

Meter 6

Bldg. No.	Building Name	Occupancy Type	Gross Area (Sq. Ft.)	Heating Load Factor (BTUH/sq.ft.)	Estimated Heating Load (CFH)	Estimated Domestic Load (CFH)	Total Gas Load (CFH)
75	Maintenance Ops./Sheriffs	Office/Warehouse	26,452	30	835	335	1,170
<b>TOTALS</b>							<b>1,170</b>

Meter 7

Bldg. No.	Building Name	Occupancy Type	Gross Area (Sq. Ft.)	Heating Load Factor (BTUH/sq.ft.)	Estimated Heating Load (CFH)	Estimated Domestic Load (CFH)	Total Gas Load (CFH)
70	Child Development Center	Nursery/Day Care	5,830	30	185	75	260
V-70	Child Development & Family Complex	Nursery/Day Care	19,771	30	*1,020	*910	1,930
V-71	Family Resource Center	Community-Public Gathering	8,869	40	375	225	600
<b>TOTALS</b>							<b>2,790</b>

\* Indicates actual load demand based on installed gas fired equipment.

\*\* Indicates anticipated load demand based on anticipated gas fired equipment.

7.4 ANALYSIS OF FUTURE NEEDS

An analysis of the current Natural Gas system was conducted to evaluate a) existing flow capacity available at the meters b) the impact of the proposed facilities on the capacity of existing gas distribution system and c) modifications/upgrades required to the existing gas distribution system to support the future build out of the campus. The current gas distribution was also analyzed for buried gas lines that will be in conflict with the proposed facilities and will require relocation. A campus site plan identifying piping that require demolition/relocation and extension of service lines to new facilities to serve the planned facilities is provided in our proposed gas site plan.

An evaluation of the facilities planned as part of the Measure 'J' master plan revealed that a net additional 370,949 square feet of buildings/spaces are planned at the campus. A review of these proposed facilities and their usage revealed that the campus would add an additional combined load of 14,950 CFH to the existing metered systems.

Partial Site Plans 'Future Utility Map - Natural Gas 7a - 7d' shows the proposed natural gas distribution piping system throughout the campus.

The following Table provides approximate Heating and Domestic load demands of the proposed facilities that are being added to the campus and are depicted by Meter numbers. Meter number designations can be found on the Utility Plans. The demands below are calculated based on building square footage.

7-2: Future Gas Demand Loads

Meter 1 - additional loads to existing system

Bldg. No.	Building Name	Occupancy Type	Projected Construction Completion Year	Gross Area (Sq. Ft.)	Heating Load Factor (BTUH/sq.ft.)	Estimated Heating Load (CFH)	Estimated Domestic Load (CFH)	Total Gas Load (CFH)
V-11	Media Art Center	Academic	2013	62,000	35	2,285	1,145	3,430
V-12	Admin./CWCD	Office	2013	79,486	30	2,510	1,005	3,515
V-15	Performance Arts Center	Academic	2013	21,693	35	800	400	1,200
V-18	Parking Structure	Parking	2014	95,948	N/A	No Gas service to this facility		-
V-22	Student Union	Academic	2013	53,538	35	1,975	990	2,965
V-51	Planetarium Expansion	Academic	2014	6,684	35	245	125	370
<b>TOTALS</b>								<b>11,480</b>

Meter 2, 3, 4,, 6, 7 - No additional loads to existing system

Bldg. No.	Building Name	Occupancy Type	Projected Construction Completion Year	Gross Area (Sq. Ft.)	Heating Load Factor (BTUH/sq.ft.)	Estimated Heating Load (CFH)	Estimated Domestic Load (CFH)	Total Gas Load (CFH)
<b>TOTALS</b>								<b>-</b>

Meter 5 - additional loads to existing system

Bldg. No.	Building Name	Occupancy Type	Projected Construction Completion Year	Gross Area (Sq. Ft.)	Heating Load Factor (BTUH/sq.ft.)	Estimated Heating Load (CFH)	Estimated Domestic Load (CFH)	Total Gas Load (CFH)
V-13	Athletic Training Facility	Gym	2012	18,000	45	850	595	1,445
V-14	Baseball Field House	Gym	2012	10,000	N/A	No Gas service to this facility		-
V-16	Multi-Purpose PE/Community Serv. Ctr.	Community-Public Gathering	2013	30,000	40	1,265	760	2,025
<b>TOTALS</b>								<b>3,470</b>

7.5 FINDINGS AND RECCOMENDATIONS

An evaluation of the existing Natural Gas system was undertaken to study the modifications/upgrades required to support the future facilities planned at the campus. The study also evaluated the reliability and redundancy of the existing system.

A review of the load demands of the future facilities and current load demands with loads of the demolished buildings subtracted from the totals of the campus revealed that the existing main medium pressure distribution lines are adequately sized to meet the demands of existing and future facilities on the campus however meter upgrades with a higher capacity output will be required in some locations.

The recommendations have been categorized into three priority levels. Descriptions of each priority level are provided in the executive summary of this report. The following are our recommendations to upgrade the existing Natural Gas infrastructure at the campus to (a) Improve system reliability (b) provide ease of maintenance and isolation of lines either during a failure or during a regular maintenance without interrupting gas supply to other buildings on campus and (c) to provide adequate capacity service lines to accommodate existing loads and planned future loads resulting from new buildings addition as well as additions to existing buildings:

Bldg. No.	Building Name	Gross Area (Sq. Ft.)	Description of Impact
V-11	Media Art Center	62,000	The proposed building does not interfere with the existing underground gas service lines. The proposed building will be served from a new service line extended from the existing system fed from meter 1.
V-12	Admin./CWCD	79,486	The proposed building does not interfere with the existing underground gas service lines. The proposed building will be served from a new service line extended from the existing system fed from meter 1. Existing lateral previously serving Administration is not of adequate size to handle new load.
V-13	Athletic Training Facility	18,000	The proposed building does not interfere with the existing underground gas service lines. The proposed building will be served from a new service line extended from the existing system fed from meter #5.
V-15	Performing Arts Center	21,693	The proposed building does not interfere with the existing underground gas service lines. The proposed building will be served from a new service line extended from the existing system fed from meter 1.
V-16	Multi-Purpose PE/Community Service Center	30,000	The proposed building does not interfere with the existing underground gas service lines. The proposed building will be served from a new service line extended from the existing system fed from meter #5.
V-22	Student Union	53,538	The proposed building interferes with an existing underground city owned gas service line serving the main campus meter. This line shall be relocated. A proposed line is re-routed around the proposed bldg. V-22. A supply line shall extend to serve this building. This service will be extended from the existing system fed from Meter #1.
V-51	Planetarium Expansion	6,684	The proposed building interferes with an existing underground campus gas service line which currently serves a few bungalows. This line can be abandoned or capped and removed. A supply line shall extend to serve this building. This service will be extended from the existing system fed from Meter #1.

The following is a summary of additional recommendations for improvements to the existing natural gas system:

Priority 1

- In order to accommodate future loads, the piping at the end of the loop by the existing music building will have to be field verified to ensure that a loop does occur and that it can provide adequate capacity to the proposed 2" line serving the future Media Arts (V-11) and Performing Arts Center (V-15).
- An alternative to the recommendation above, replace the dual steel distributions main lines beginning in monarch square area and extend north with a 4" - 6" P.E. line.
- Earthquake valves for emergency gas supply shut-off should be provided at each meter location on the downstream side of the regulator.

Priority 3

- We also recommend that all buildings be sub-metered to monitor gas consumption and get a clear understanding of the total gas energy being spent at each of the buildings. This will help the campus better manage their energy budget and thus the operating costs at the campus. Priority 1 - Table 7-3 below provides connected load demands of the existing, future facilities and facilities that are being demolished. This information reveals the following;

Meter 1: Replace existing meter with a higher capacity meter having a max CFH output of no less than 40,000 CFH. Southern California Gas Company shall provide this service.

Meter 2: Replace existing meter with a higher capacity meter having a max CFH output of no less than 20,000 CFH. Southern California Gas Company shall provide this service.

Meter 3: The use of this meter can be discontinued. City owned distribution supply line should be capped. Southern California Gas Company shall provide this service. The meter and associated components shall also be removed.

Meter 4: The use of this meter can be discontinued. City owned distribution supply line should be capped. Southern California Gas Company shall provide this service. The meter and associated components shall also be removed.

Meter 5: Replace existing meter with a higher capacity meter having a max CFH output of no less than 15,000 CFH. Southern California Gas Company shall provide this service.

Meter 6: This system shall remain as is.

Meter 7: Specifics of this meter are unknown however this meter shall have a max CFH output of no less than 5,000 CFH.

Table 7-3: Existing/Future Gas Demand Loads

<u>Meter 1</u>			<u>Meter 2</u>		
Bldg. No.	Building Name	Combined Gas Load –Heating / Domestic (CFH)	Bldg. No.	Building Name	Combined Gas Load –Heating / Domestic (CFH)
<b>Existing</b>					
01	Administration	0	77	Central Power Plan	20,000
03	Foreign Language	895	<b>TOTALS</b>		
06	Engineering	1,335	<b>20,000</b>		
07	South Gym	3,640			
08	Life Science	1,140			
09	Cafeteria	0			
10	Theater Arts	0			
11	Music	905			
19	Business & Journalism	1,255			
48	Art	1,050			
50	Math Science	1,085			
52	Behavioral Science	760			
53	Humanities	1,075			
54	Motion Pictures /TV Studio	265			
56	Campus Center	4,620			
68	Library/Academic Res. Ctr.(LARC)	5,135			
76	Allied Health Science (AHS)	1,050			
102-1	Student Services Center	1,110			
102-2	Student Services Center	1,110			
B 80-85	Bungalows	0			
<b>Future</b>					
V-11	Media Arts Center	3,430			
V-12	Administration/CWCD	3,515			
V-15	Performance Arts Center	1,200			
V-22	Student Union	2,965			
V-51	Planetarium Expansion	370			
<b>TOTALS</b>		<b>37,910</b>			

Meter 3

Bldg. No.	Building Name	Combined Gas Load –Heating / Domestic (CFH)
B 1-2	Bungalows	0
B 3-6	Bungalows	0
B 7-8	Bungalows	0
B 9-10	Bungalows	0
B 11	Bungalow	0
B 12	Bungalow	0
B 13-14	Bungalows	0
B 15	Bungalow	0
B 16	Historical Museum Bungalow	0
B 24-26	Bungalows	0
B 31-30	Bungalows	0
B 32-34	Bungalows	0
B 36-35	Bungalows	0
B 37-38	Bungalows	0
B 45-47	Reading Center Bungalows	0
B 49-48	Bungalows	0
B 50-52	Bungalows	0
B 70	Family Resource Center bungalow	0
B 71	Bungalow	0
B 72-73	Bungalows	0
B 74	Cooperative Ed. Bungalow	0
B xx-xx	Bungalows	0
<b>TOTALS</b>		<b>0</b>

Meter 4

Bldg. No.	Building Name	Combined Gas Load –Heating / Domestic (CFH)
47	Field House	0
64	Gymnastic Center	0
78	Drawing/Music	0
<b>TOTALS</b>		<b>0</b>

Meter 5

Bldg. No.	Building Name	Combined Gas Load –Heating / Domestic (CFH)
67	North Gym	3,060
	Pool House	5,660
V-13	Athletic Training Facility	1,445
V-16	Multi-Purpose PE/Community Service Center	2,025
<b>TOTALS</b>		<b>12,190</b>

Meter 6

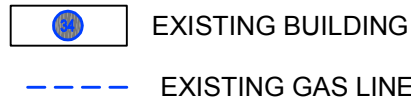
Bldg. No.	Building Name	Combined Gas Load –Heating / Domestic (CFH)
75	Maintenance Ops./Sheriffs	1,170
<b>TOTALS</b>		<b>1,170</b>

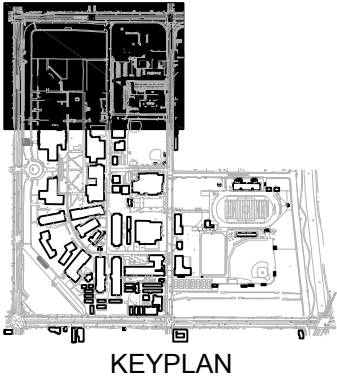
Meter 7 - TBD

Bldg. No.	Building Name	Combined Gas Load –Heating / Domestic (CFH)
70	Child Development Center	0
V-70	Child Development & Family Complex	875
V-71	Family Resource Center	600
<b>TOTALS</b>		<b>1,475</b>

*RED* Indicates buildings to be Demolished in the future, therefore building loads were not included in the total

*(Page Intentionally Left Blank)*

**LEGEND:**  




**NOTE:**  
 1. REFER TO TABLES ES-1 AND ES-2 FOR BUILDING NAMES.  
 2. THE INFORMATION SHOWN HEREON IS A GRAPHICAL DEPICTION OF THE EXISTING CAMPUS UTILITY SYSTEMS. THE SITE SURVEY AND INFRASTRUCTURE STUDIES EXISTING UTILITY PLANS PREPARED UNDER SEPARATE COVER SHALL BE REFERENCED FOR DETAILED INFORMATION

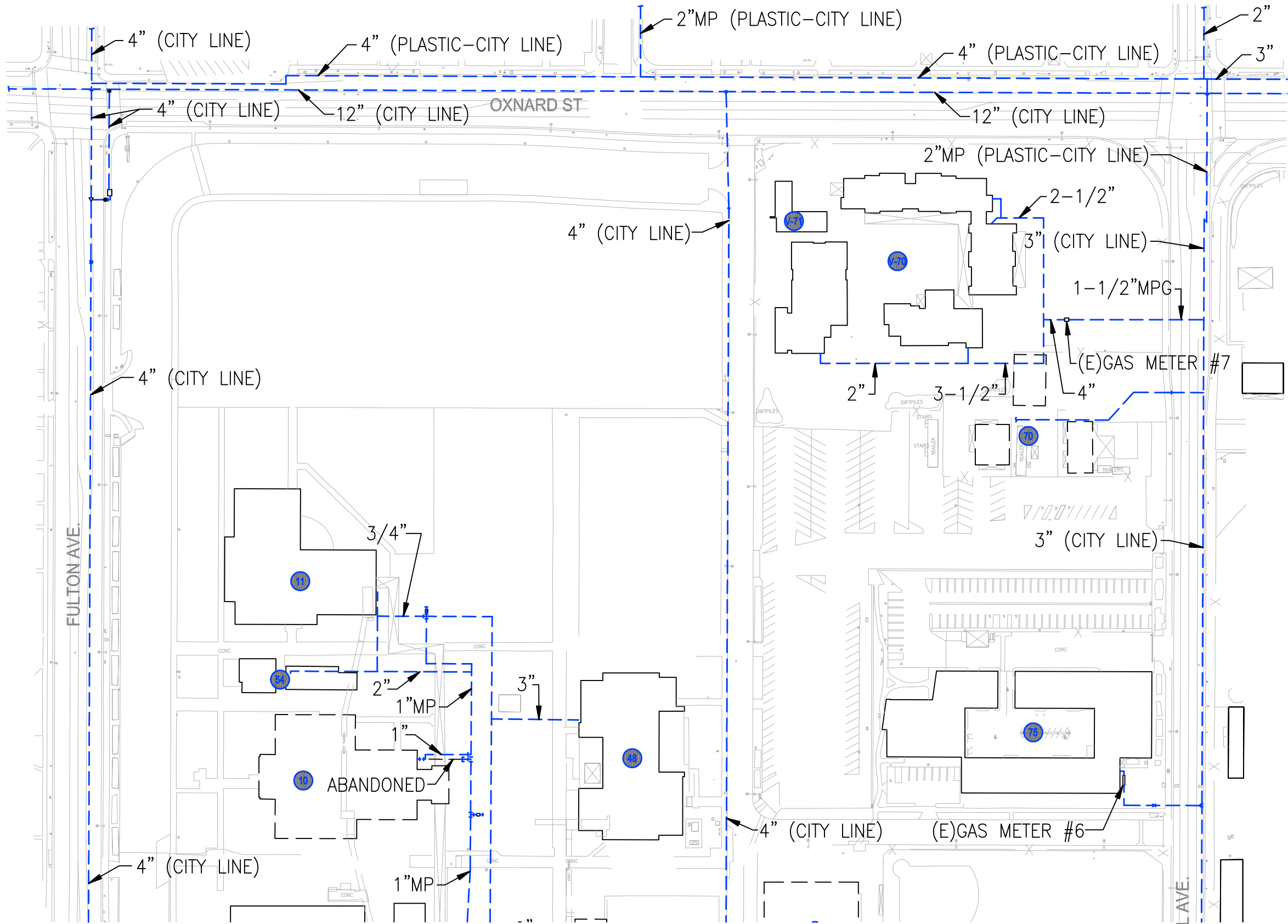
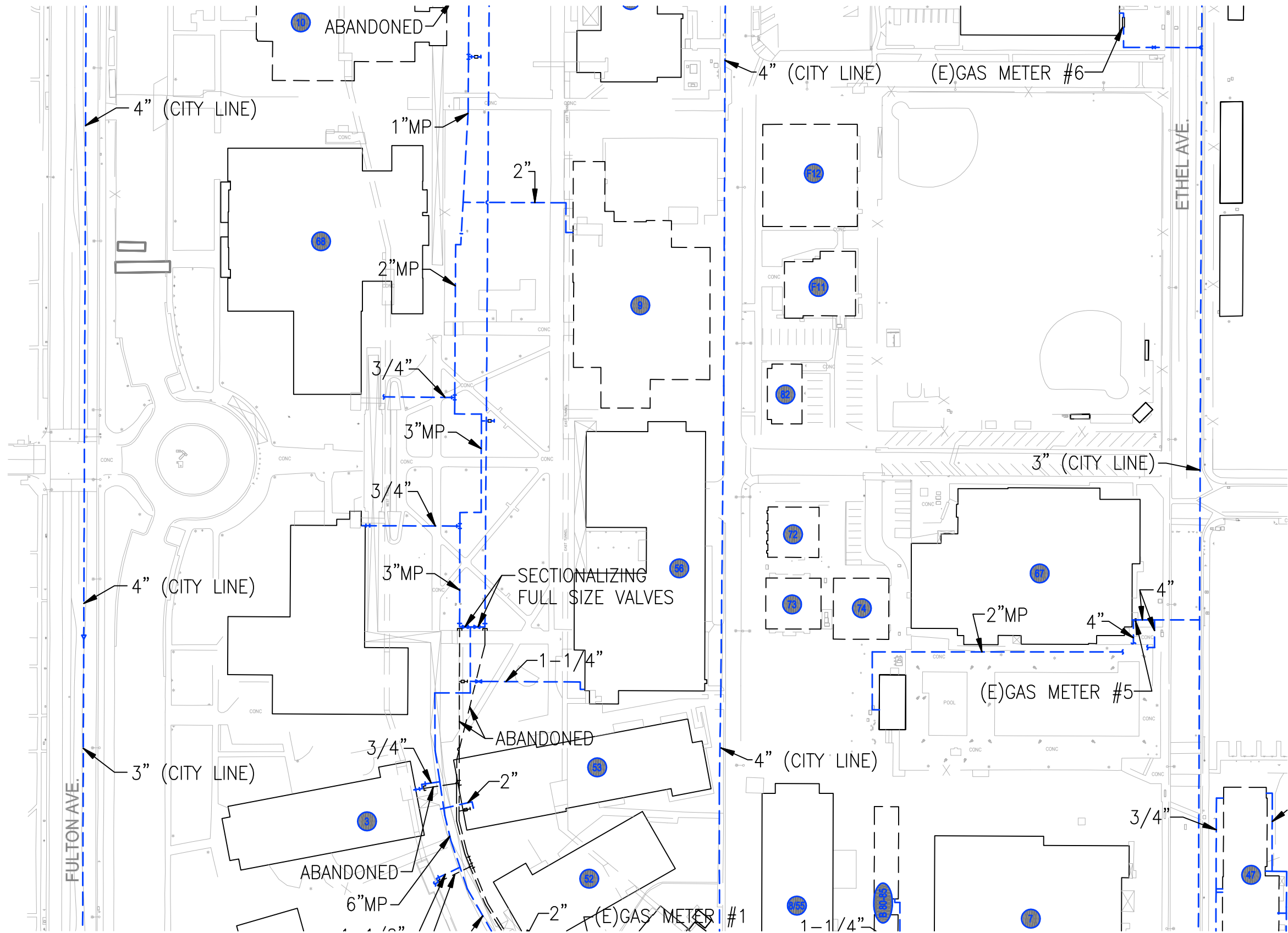




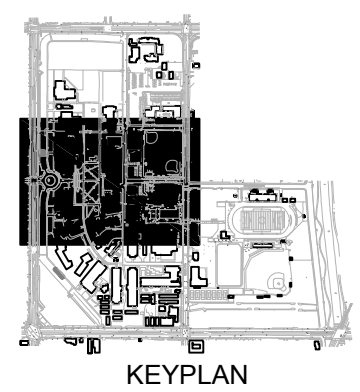
FIGURE 7a  
 EXISTING CONDITIONS UTILITY MAP - NATURAL GAS

*(Page Intentionally Left Blank)*



**LEGEND:**

-  EXISTING BUILDING
-  EXISTING GAS LINE

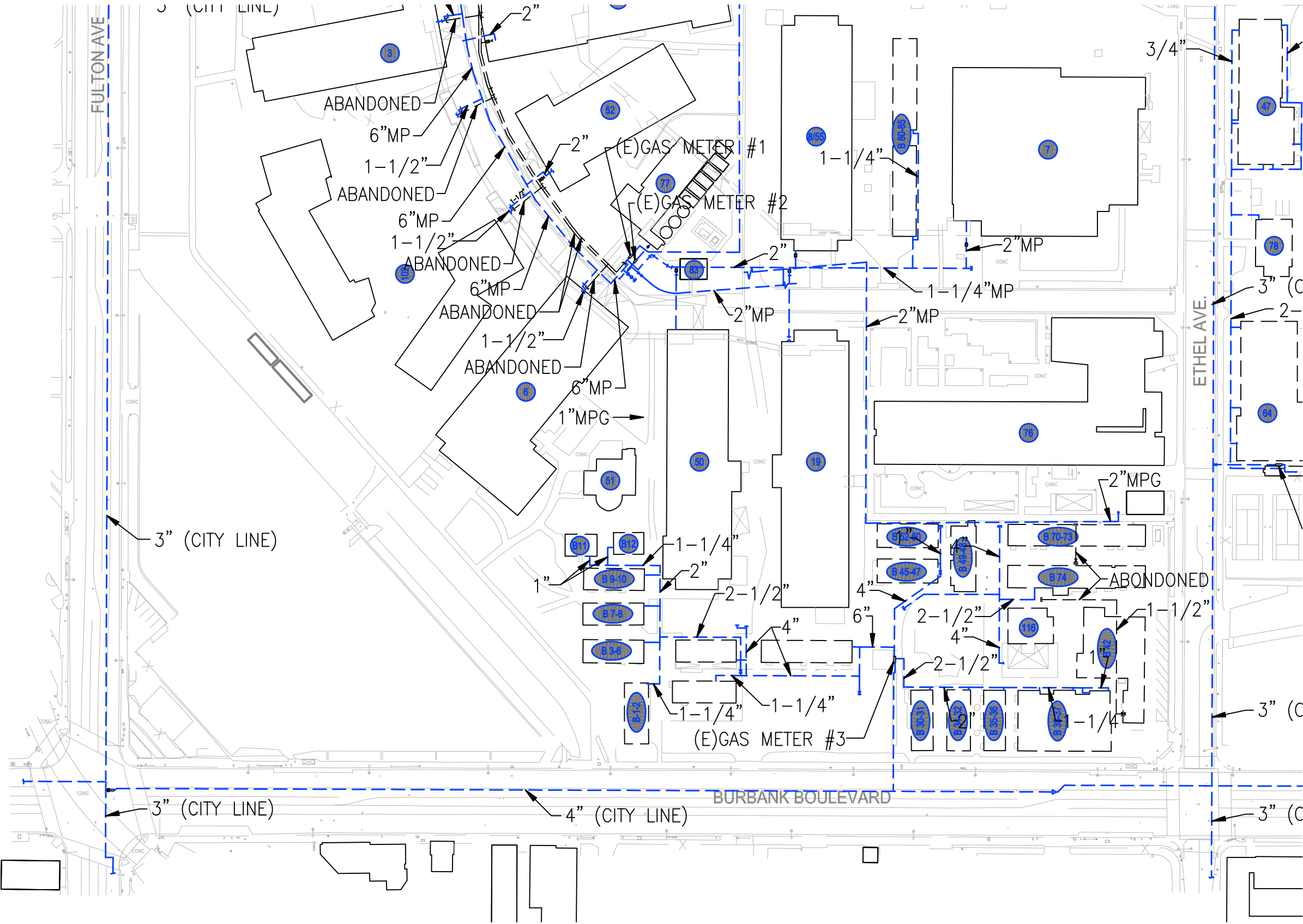




- NOTE:**
1. REFER TO TABLES ES-1 AND ES-2 FOR BUILDING NAMES.
  2. THE INFORMATION SHOWN HEREON IS A GRAPHICAL DEPICTION OF THE EXISTING CAMPUS UTILITY SYSTEMS. THE SITE SURVEY AND INFRASTRUCTURE STUDIES EXISTING UTILITY PLANS PREPARED UNDER SEPARATE COVER SHALL BE REFERENCED FOR DETAILED INFORMATION

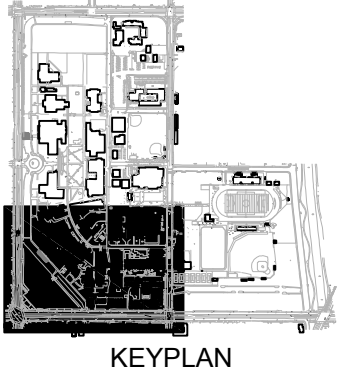


FIGURE 7b  
 EXISTING CONDITIONS UTILITY MAP - NATURAL GAS

*(Page Intentionally Left Blank)*



**LEGEND:**  
 EXISTING BUILDING  
 EXISTING GAS LINE

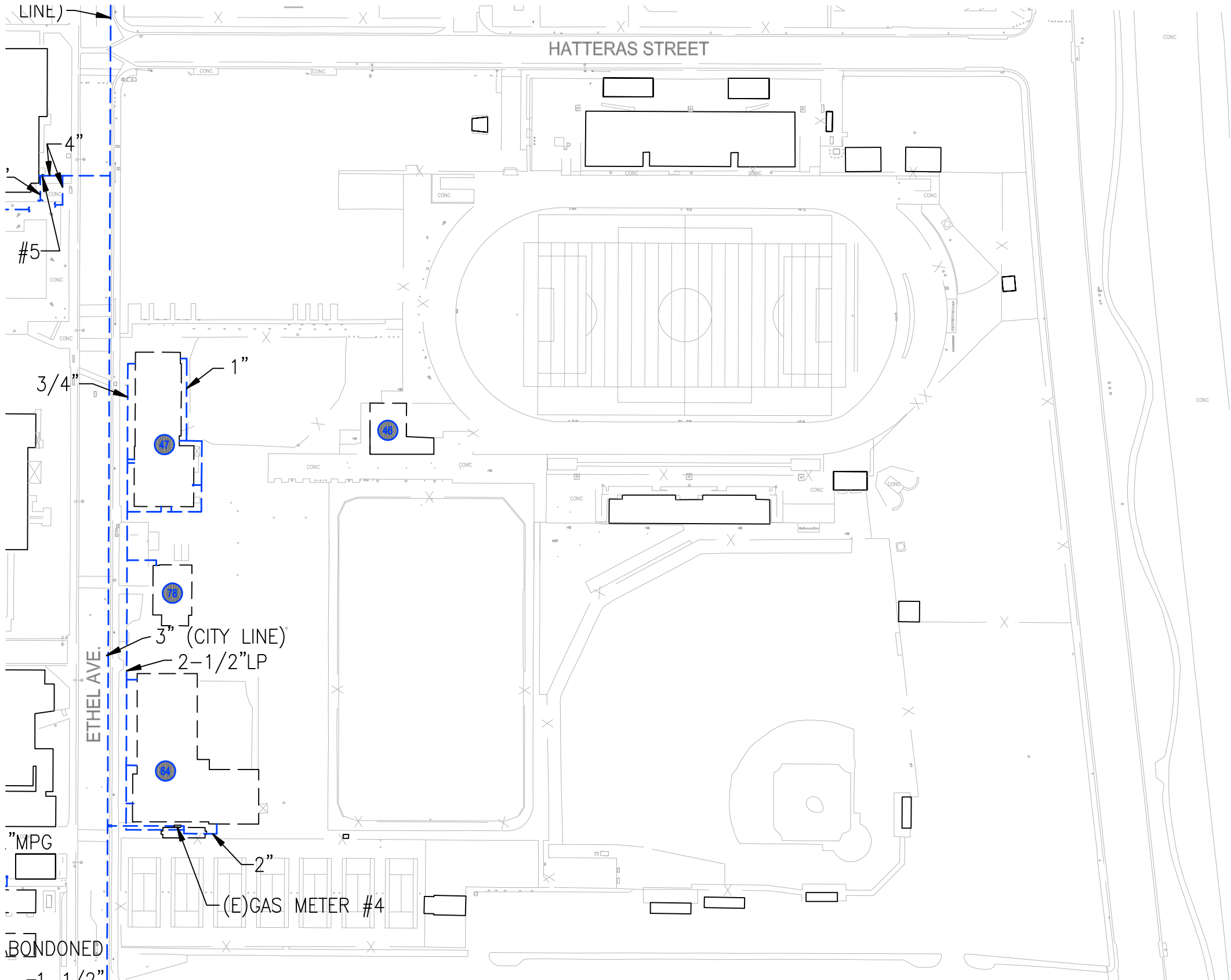


**NOTE:**  
 1. REFER TO TABLES ES-1 AND ES-2 FOR BUILDING NAMES.  
 2. THE INFORMATION SHOWN HEREON IS A GRAPHICAL DEPICTION OF THE EXISTING CAMPUS UTILITY SYSTEMS. THE SITE SURVEY AND INFRASTRUCTURE STUDIES EXISTING UTILITY PLANS PREPARED UNDER SEPARATE COVER SHALL BE REFERENCED FOR DETAILED INFORMATION





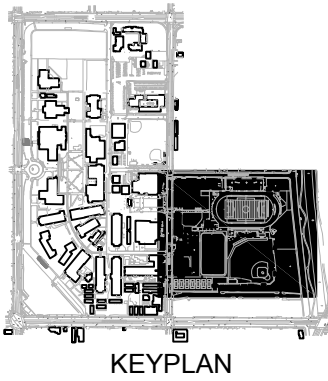
FIGURE 7c  
 EXISTING CONDITIONS UTILITY MAP - NATURAL GAS

*(Page Intentionally Left Blank)*



**LEGEND:**

-  EXISTING BUILDING
-  EXISTING GAS LINE

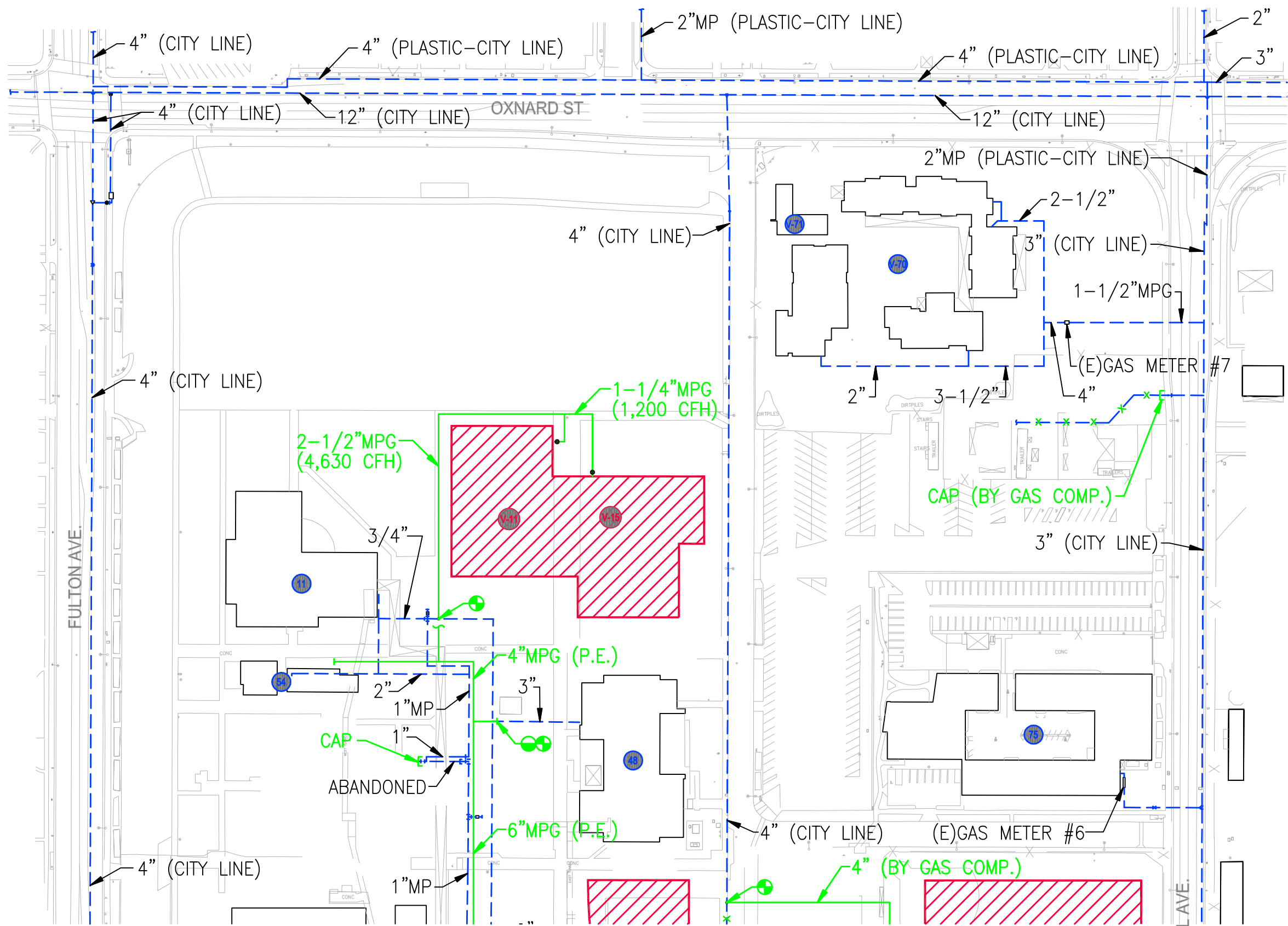


- NOTE:**
1. REFER TO TABLES ES-1 AND ES-2 FOR BUILDING NAMES.
  2. THE INFORMATION SHOWN HEREON IS A GRAPHICAL DEPICTION OF THE EXISTING CAMPUS UTILITY SYSTEMS. THE SITE SURVEY AND INFRASTRUCTURE STUDIES EXISTING UTILITY PLANS PREPARED UNDER SEPARATE COVER SHALL BE REFERENCED FOR DETAILED INFORMATION



FIGURE 7d  
 EXISTING CONDITIONS UTILITY MAP - NATURAL GAS

*(Page Intentionally Left Blank)*



- LEGEND:**
- EXISTING BUILDING
  - PROPOSED MEASURE J BUILDING
  - EXISTING GAS LINE
  - PROPOSED GAS LINE
  - PROPOSED P.O.C. (POINT OF CONNECTION)
  - PROPOSED P.O.D. (POINT OF DISCONNECTION)
  - GAS LINE TO BE REMOVED
  - EXIST. GAS METER TO BE REMOVED
  - PRESS. REGULATOR & S.O.V. AT BLDG. POINT OF ENTRY

- NOTE:**
1. REFER TO TABLES ES-1 AND ES-2 FOR BUILDING NAMES.
  2. THE INFORMATION SHOWN HEREON IS A GRAPHICAL DEPICTION OF THE EXISTING CAMPUS UTILITY SYSTEMS. THE SITE SURVEY AND INFRASTRUCTURE STUDIES EXISTING UTILITY PLANS PREPARED UNDER SEPARATE COVER SHALL BE REFERENCED FOR DETAILED INFORMATION
  3. FUTURE CONDITIONS UTILITY MAPS SHOW ONLY THE DISPOSITION OF FUTURE BUILDINGS. REFER TO FIGURE 0e-MEASURE J MASTER PLAN SUMMARY FOR COMPLETE LAYOUT OF FUTURE CONDITIONS.

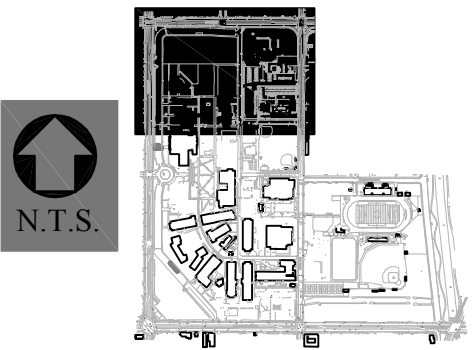


FIGURE 7e  
 FUTURE CONDITIONS UTILITY MAP - NATURAL GAS

*(Page Intentionally Left Blank)*

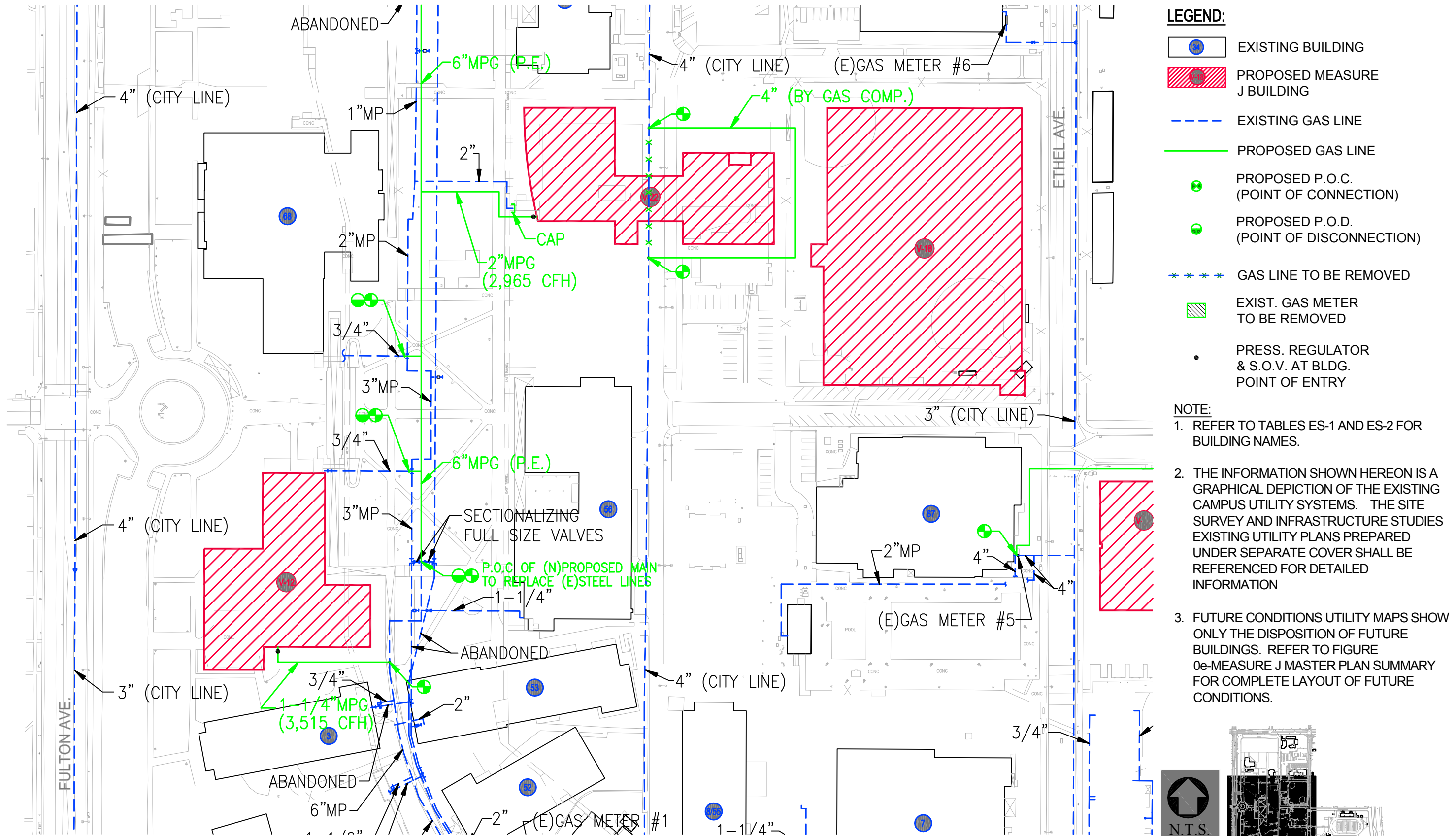
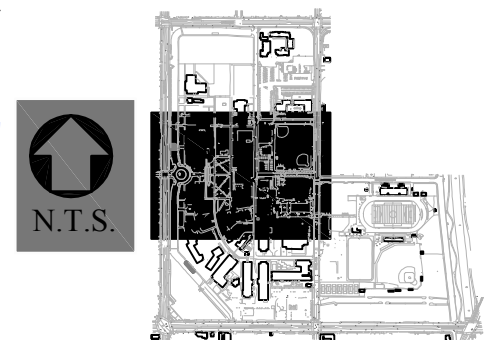


FIGURE 7f  
 FUTURE CONDITIONS UTILITY MAP - NATURAL GAS



*(Page Intentionally Left Blank)*

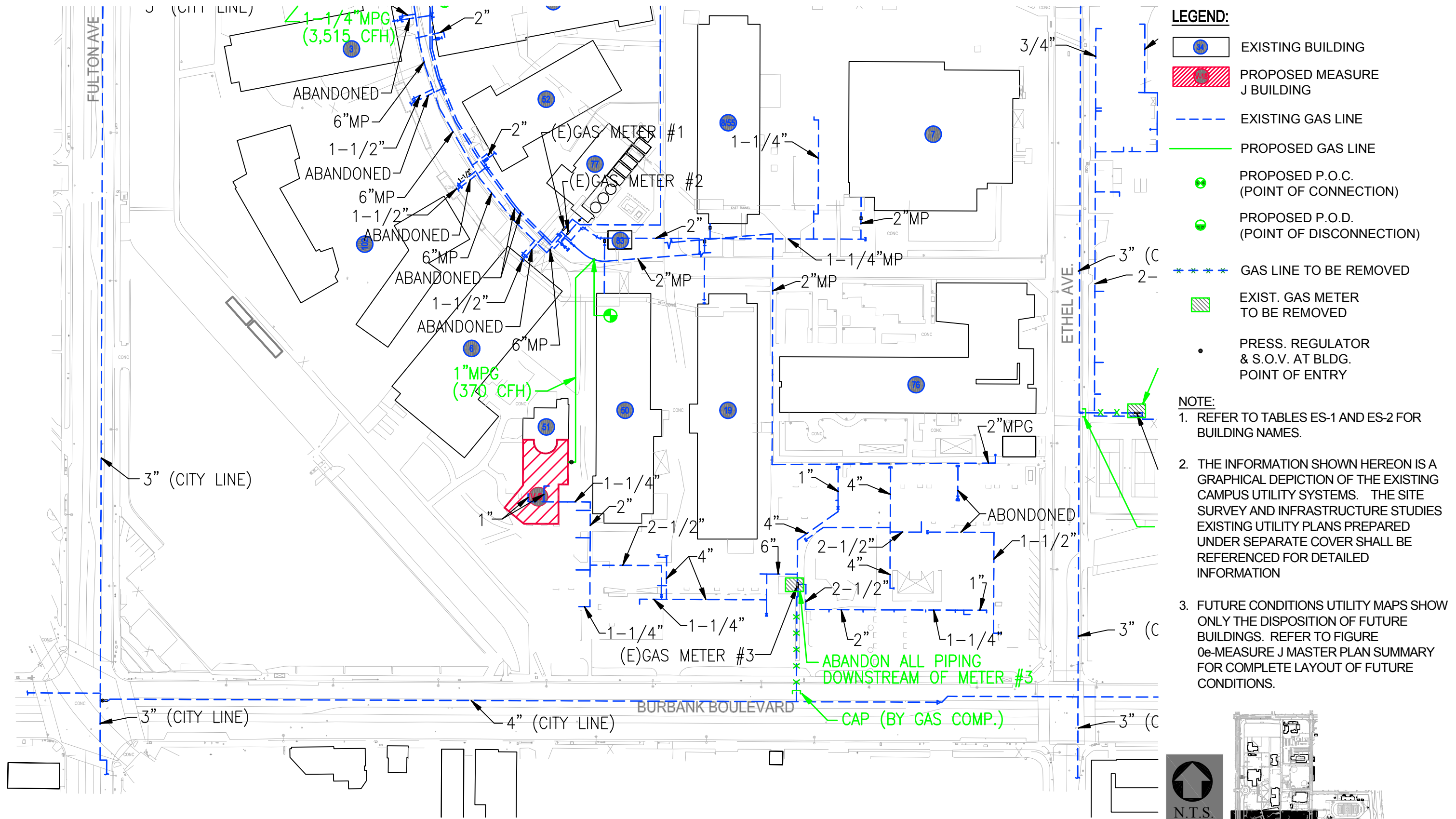
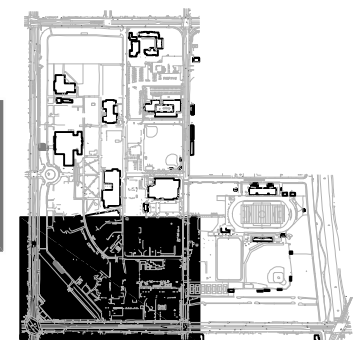
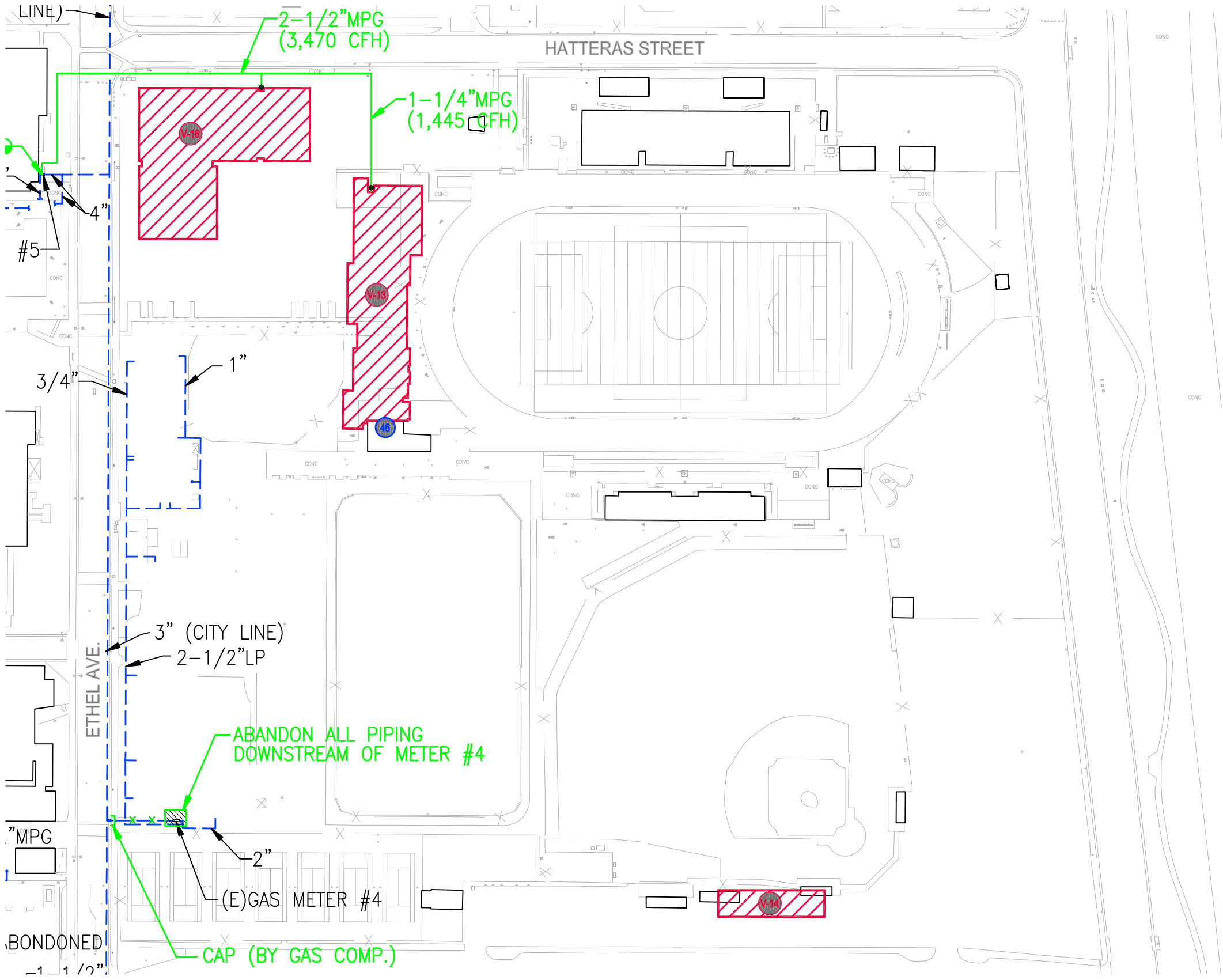


FIGURE 7g  
 FUTURE CONDITIONS UTILITY MAP - NATURAL GAS



*(Page Intentionally Left Blank)*



- LEGEND:**
- EXISTING BUILDING
  - PROPOSED MEASURE J BUILDING
  - EXISTING GAS LINE
  - PROPOSED GAS LINE
  - PROPOSED P.O.C. (POINT OF CONNECTION)
  - PROPOSED P.O.D. (POINT OF DISCONNECTION)
  - GAS LINE TO BE REMOVED
  - EXIST. GAS METER TO BE REMOVED
  - PRESS. REGULATOR & S.O.V. AT BLDG. POINT OF ENTRY

- NOTE:**
1. REFER TO TABLES ES-1 AND ES-2 FOR BUILDING NAMES.
  2. THE INFORMATION SHOWN HEREON IS A GRAPHICAL DEPICTION OF THE EXISTING CAMPUS UTILITY SYSTEMS. THE SITE SURVEY AND INFRASTRUCTURE STUDIES EXISTING UTILITY PLANS PREPARED UNDER SEPARATE COVER SHALL BE REFERENCED FOR DETAILED INFORMATION
  3. FUTURE CONDITIONS UTILITY MAPS SHOW ONLY THE DISPOSITION OF FUTURE BUILDINGS. REFER TO FIGURE 0e-MEASURE J MASTER PLAN SUMMARY FOR COMPLETE LAYOUT OF FUTURE CONDITIONS.

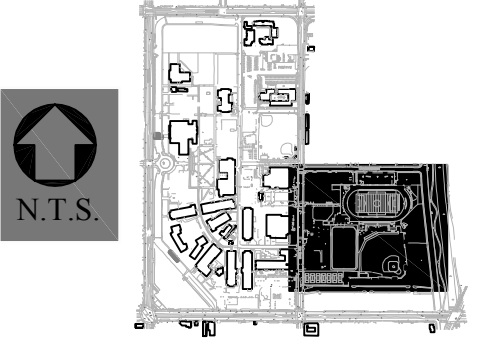


FIGURE 7h  
 FUTURE CONDITIONS UTILITY MAP - NATURAL GAS

*(Page Intentionally Left Blank)*

**SECTION 8 – CHILLED WATER SYSTEM**

**8.1 SYSTEM DESCRIPTION**

Campus chilled water is supplied by the central plant located near south end of Campus Drive adjacent to the Life Science Building. There are two pairs of underground chilled water supply and return branches serving the campus from the 12” chilled water supply and return mains in the central plant building: west tunnel loop and east tunnel loop. The west tunnel loop is served by 8” CHW S & R header pipes. And the east tunnel loop is served by 10” CHW S & R header pipes.

**WEST TUNNEL - North West / South West Tunnel Loop**

The 8” CHW S & R pipes serving the west tunnel loop run out to south west end of Campus Drive and follow through student walkway to the northwest. There are two pairs of 6” and 4” CHWS&R buried stub-outs with isolation valves that branch west towards the new upcoming Library/Academic Resource Center (LARC) and Student Services Center Buildings respectively for their hook-up services. From the northwest corner of the west tunnel, the existing 3” CHW S & R pipes through wall to Music Building. Additionally, 3” CHW S & R pipes through tunnel wall and connected to the new Music Building Annex and the existing Motion Picture Building. For headed further south direction, the existing 3” CHW S & R pipes through wall to Theater Arts Building. The existing 3” CHW S & R pipes through tunnel wall to Administration Building. The existing 3” CHW S & R pipes through tunnel wall to Foreign Language Building. The 4” CHW S & R pipes through tunnel wall and in trench to Engineering Building. The existing 4” CHW S & R pipes through tunnel wall to Business & Journalism Building. The existing 3” CHW S & R pipes tee off from Business & Journalism Building crawl space and continue to the west direction below grade to the southeast end of Math, Earth Science Building. At this point there are 8” CHWS&R buried stub-outs with isolation valves towards the East between the south end bypass tie-in loop and then routed south east and then south direction in trench toward the Allied Health Science Building.

**EAST TUNNEL - North East / South East Tunnel Loop**

The 10” CHWS&R pipes serving the east tunnel loop run out to south east end of Campus Drive and follow through student walkway to the northeast. From the northeast corner of the east tunnel, the existing 3” CHW S & R pipes through tunnel wall to Art and Cafeteria Buildings respectively. After those buildings, the existing 4” and 3” CHW S & R pipes through tunnel wall to Campus Center and Humanities Buildings respectively. Prior to central plant, the existing 3” CHW S & R pipes through tunnel wall to Behavioral Sciences Building. After central plant, the existing 4” and 3” CHW S & R pipes through tunnel wall to Life Sciences and South Gym Buildings respectively.

**8.2 METHODOLOGY**

The size of the distribution piping mains and branches for the Los Angeles Valley College – Measure J Utility Master Plan were studied using the following methodologies:

Information regarding the size, usage and chilled water demands of each building or complex which will utilize the campus chilled water system to meet their cooling needs was compiled through various sources. Much of the information regarding older campus buildings was provided by the campus in the form of historical documentation, as built drawings. Some information was obtained using documentation from a previous energy retrofit project. Several buildings were based on current proposed or actual construction documents. The balance was determined by applying accepted engineering practice rule of thumb factors based on individual building occupancy and usage type.

When known actual installed tonnage was used for the cooling design peak load (tons). Where this information was not known, the building area was multiplied by an accepted square foot/ton factor. This factor was determined based on a combination of experience, good engineering design practice and referenced material from the 2009 ASHRAE Fundamentals.

An average diversity of 0.60 was used as a basis for determining the required equipment capacities and distribution piping sizes. This is consistent with the diversity used for the central plant expansion project which is currently completed. This assumption also includes a maximum of 75% for the total connected load will require chilled water at any one time in Allied Health Science Building. Based on extensive experience in the design of campus central plant systems, an average diversity of 60% is still a slightly conservative basis of design for the Los Angeles Valley College campus.

Having determined the diversified tonnage for each building or complex of buildings to be served by the central plant a diversified GPM was calculated. Diversified GPM is calculated using the formula;

$$Q = \text{Load} / (500 * \Delta T)$$

Where

Load = diversified tonnage x 12,000, Btu/h  
 Q=flow rate, GPM  
 ΔT=temperature increase or decrease, °F

**8.3 ANALYSIS OF EXISTING SYSTEM**

The current average chilled water temperature difference, ΔT (°F), for this campus is 14°F. The calculated GPM shown on the Utility Master Plan Chilled Water System table assumes all existing buildings and all buildings scheduled to be operational by the end of 2010 will use the current average chilled water temperature difference of 14°F ΔT in sizing the cooling coils for those buildings. Buildings proposed to be operational in 2012 and 2013 shall utilize a 20°F ΔT in sizing the building cooling coils.

Based on the current load estimate in the cooling load calculation, there will be no issue for campus cooling demand.

**8.4 ANALYSIS OF FUTURE NEEDS**

The total estimated chilled water load and flow requirements to serve the future campus were broken into three (3) phases. The first phase includes buildings currently on the campus chilled water system and buildings currently under construction and assumed to be operational by the end of 2012. The second phase adds proposed buildings assumed to be in operation by the end of 2013. The third phase adds the proposed buildings assumed to be operational by the end of 2014. In addition, buildings to be demolished were removed from the system as indicated in the table. Completed construction for proposed buildings is based on the LAVC proposed campus buildings list provided by the Campus.

Having determined the required chilled water system GPM through the year 2014, a hydraulic flow spreadsheet calculation was constructed to analyze the existing underground chilled water distribution piping and pumping systems. The spreadsheet calculation was constructed using known parameters with regards to location of the central plant in relationship to each building. The routing and material of the distribution piping to each building was based on information obtained using historical documentation and a site survey performed by P2S Engineering personnel. Each building was then set at its diversified GPM to determine the hydraulically most remote building. At completion of the 2013 buildings the Media Art/Performance Arts Center Buildings are the hydraulically most remote building on the campus chilled water system. In the final spreadsheet calculation of the Media Art/Performance Arts Center Buildings coil is set to fully open to simulate the building peak condition. This allows the spreadsheet calculation to determine the pressure losses and velocities through the piping system when there is maximum flow to the hydraulically most remote buildings like the Media Art/Performance Arts Center. This data was used to determine where piping and distribution pumping modifications would be warranted and as required.

**8.5 FINDINGS AND RECOMMENDATIONS**

The recommendations have been categorized into three priority levels. Descriptions of each priority level are provided in the executive summary of this report.

The hydraulic flow spreadsheet calculation was used to evaluate the chilled water piping system based on the following criteria: maximum velocity of 6 ft/sec in piping 6” and below, maximum velocity of 10 ft/sec in piping above 6” and a maximum variable primary pump head of 140 feet. Based on these criteria we have the following piping recommendations:

Priority 1

- Provide the 6” main in North East Tunnel to serve the proposed Media Art and Performance Arts Centers.

The existing north east tunnel branch is currently serving the Art Building with the 6” branch main. The extension of this 6” line size will be sufficient to serve the 251 GPM of peak load flow requirement

for the Media Art/Performance Arts Center. The resulting fluid velocity would approach 3.0 ft/sec. By extending the existing 6" north east tunnel end branch from the Art Building to the Media Art/Performance Arts Center is recommended. This would allow for additional flow capacity in the future at this side of the campus.

- Replace the existing 3" loop at the north-west tunnel end branch with the new 6" piping to improve the current operational issue per LAVC Facility Department.

Priority 2

- Completing the 6" piping bridge connection loop between north-west tunnel end branches to north east tunnel end branch is recommended to enhance the system flexibility in the event additional development or building renovation in this part of the campus occurs in the future.

- Replace the existing 2-pipe system at the Life Science Building with the new 4-pipe system to improve the current operational issue per LAVC Facility Department.
- Provide the new 3" CHW S&R connections to the existing North Gym Building from Central Plant per LAVC Facility Department.
- Replace the existing 6" CHW S&R loops at the south-east tunnel header branch with the new 8" piping if when the decision has made to connect the Athletic Center Buildings from Central Plant.

Priority 3

- Due to the remoteness and its associated cost for piping installation from central plant, Athletic Training Facility and Multi-Purpose PE/Community Services Center will have a satellite central plant to serve their needs for chilled water or standalone packaged rooftop

DX units for cooling. It is recommended that the feasibility study is conducted to investigate the option of Micro-turbine technology for the buildings' cooling requirements.

- Due to the remoteness and its associated cost for piping installation from central plant, Child Development & Family Complex and Family Resource Center, and M&O-Sheriff Office will have a satellite central plant to serve their needs for chilled water after current standalone packaged rooftop DX units' useful lifecycle ended (approximately next 5 years). It is recommended that the feasibility study is conducted to investigate the option of Micro-turbine technology for the buildings' cooling requirements.

Los Angeles Valley College							Existing Conditions Estimations 2010			Estimated Expansion Thru 2011			Estimated Expansion Thru 2012			Estimated Expansion Thru 2013/2014			2011			2012/2013/2014			2014		
Building Name	Gross Square Footage	How Presently Served	Calculated Peak chilled water GPM Shown *	Calculated Cooling Design Peak Load based on GPM shown (tons) *	Cooling Design Peak Load (tons)	Peak Design Square Foot / Ton	Observed Diversity	Cooling Load w/ Observed Diversity (tons)	Square Foot / Ton	Observed Diversity	Cooling Load w/ Observed Diversity (tons)	Square Foot / Ton	Observed Diversity	Cooling Load w/ Observed Diversity (tons)	Square Foot / Ton	Observed Diversity	Cooling Load w/ Observed Diversity (tons)	Square Foot / Ton	GPM based on deg dT & diversified tons	Cooling Load w/ Observed Diversity (tons)	GPM based on deg dT & peak tons	* GPM based on deg dT & diversified tons	Cooling Load w/ Observed Diversity (tons)	* GPM based on deg dT & peak tons	* GPM based on deg dT at N-E Leg w/North Loop	Observed Diversity GPM based on deg dT at N-E Leg w/North Loop	
FOREIGN LANGUAGE	16,130	West Tunnel	114	67	67	243	0.50	33	485	0.50	-	-	0.50	-	-	0.50	-	-	57	33	114						
ENGINEERING	24,145	West Tunnel	147	74	74	329	0.50	37	657	0.50	-	-	0.50	-	-	0.50	-	-	74	37	147						
SOUTH GYM	45,200	East Tunnel	144	96	96	471	0.50	48	942	0.50	-	-	0.50	-	-	0.50	-	-	82	48	165						
LIFE SCIENCE	20,660	West Tunnel	160	93	93	222	0.50	47	444	0.50	-	-	0.50	-	-	0.50	-	-	80	47	159						
MUSIC BUILDING & RECITAL HALL	16,441	West Tunnel	95	55	55	297	0.50	28	593	0.50	-	-	0.50	-	-	0.50	-	-	48	28	95						
ART BUILDING & ART GALLERY	18,965	East Tunnel	118	69	69	276	0.60	41	459	0.60	-	-	0.60	-	-	0.60	-	-	71	41	118				118	71	
BUSINESS & JOURNALISM	22,590	West Tunnel	182	106	106	213	0.50	53	426	0.60	-	-	0.60	-	-	0.60	-	-	91	53	182						
MATH & SCIENCES	19,611	West Tunnel	155	90	90	217	0.50	45	434	0.50	-	-	0.50	-	-	0.50	-	-	78	45	155						
PLANETARIUM	2,616				15	174	0.50			0.50	-	-	0.50	-	-	0.50	-	-	0	0	26						
BEHAVIORAL SCIENCE	13,700	East Tunnel	117	68	68	201	0.50	34	401	0.50	-	-	0.50	-	-	0.50	-	-	59	34	117				117	59	
HUMANITIES	19,400	East Tunnel	142	83	83	234	0.50	41	468	0.50	-	-	0.50	-	-	0.50	-	-	71	41	142				142	71	
MOTION PICTURE/ TV STUDIO	4,700	West Tunnel	47	27	27	171	0.50	14	343	0.50	-	-	0.50	-	-	0.50	-	-	24	14	47						
CAMPUS CENTER	83,553	East Tunnel	358	224	224	373	0.60	134	622	0.60	-	-	0.60	-	-	0.60	-	-	215	134	358				358	215	
M&O SHERIFF OFFICE	26,452				75	353	0.60			0.60	-	-	0.60	-	-	0.60	-	-	0	0	129						
ALLIED HEALTH SCIENCE	80,767	West Tunnel	892	595	595	136	0.75	446	181										669	446	892						
CENTRAL POWER PLANT	5,694				3		0.66	2	2,847										3	2	5						
NORTH GYM & DSPS GYM	37,963				65	581	0.50			0.50	-	-	0.50	-	-	0.50	-	-	0	0	112						
STUDENT SERVICES CENTER	40,186	West Tunnel	230	153	153	263	0.60	92	437	0.60	-	-	0.60	-	-	0.60	-	-	138	92	230						
CHILD DEVELOPMENT & FAMILY COMPLEX	25,904				77		0.60			0.60	-	-	0.60	-	-	0.60	-	-	0	0	132						
LIBRARY & ACADEMIC RESOURCE CENTER	92,922	West Tunnel	450	300	300	310	0.60			0.60	180	516	0.60			0.60			270	180	450						
SWIMMING POOLS					10																						
MEDIA ARTS CENTER	62,000	East Tunnel	311	207	207	300	0.60			0.60			0.60			0.60	124	499				0	0	15	311	186	
PARKING STRUCTURE	95,948																										
ATHLETIC TRAINING FACILITY	18,000		60	40	40	450	0.50			0.50			0.50			0.50						0	0	60			
PERFORMANCE ARTS CENTER	21,693	East Tunnel	108	72	72	301	0.60			0.60			0.60			0.60	43	502				65	43	108	108	65	
MULTI-PURPOSE PE / COMMUNITY SERVICES CENTER	30,000		113	75	75	400	0.50			0.50			0.50			0.50						0	0	113			
ADMINISTRATION/CWCD	79,486	West Tunnel	399	266	266	299	0.60	65	1,223	0.60			0.60			0.60	140	568	98	65	399	210	140	399			
STUDENT UNION	53,538	East Tunnel	201	134	134	400	0.60			0.60			0.60			0.60	80	666				121	80	201	201	121	
PLANETARIUM EXPANSION	6,684	West Tunnel	33	22	22	304										0.60	13					20	13	33			
<b>TOTAL</b>	<b>458,587</b>		<b>4,575</b>	<b>2,820</b>	<b>3,161</b>	<b>301</b>		<b>1,160</b>	<b>849</b>		<b>1,340</b>	<b>342</b>		<b>1,340</b>	<b>0</b>		<b>1,741</b>	<b>373</b>	<b>2125</b>	<b>1340</b>	<b>4173</b>	<b>582</b>	<b>388</b>	<b>1206</b>	<b>1355</b>	<b>787</b>	
				<b>341</b>									<b>TOTALS</b>				<b>1945,7115</b>						<b>2707</b>	<b>1728</b>	<b>5379</b>		

NOTE:  
\* GPM shown from Infrastructure Chilled & Hot Water Diagram, M400.1

\* GPM VALUES SHOWN BOLD/RED ARE BASED ON 16 deg dT

COLOR COORDINATION LEGEND			
BUILDINGS			
Green	EXISTING TO REMAIN		
Yellow	FUTURE TO BE DEMOLISHED		
Blue	UNDER CONSTRUCTION		
Pink	GAS PACKAGED UNITS		
Purple	GAS/ELECTRIC PACKAGED UNITS		
Cyan	AIR COOLED CHILLER SERVICE		
CELLS			
White	Data entry cells		
Light Green	Calculated Cell		
Light Orange	Observed Diversity		

North East Leg (Hydraulically longest Run)	Bldg. Branch	Branch Flow	Main Flow (GPM)	Pipe Size (")	Loss ft/100'	Pipe length(')	Loss (ft)	Fitting Loss (Elbows, Tees, Valves)				Total Loss(')		
								(%)	EQ. Ft	Loss Ft(Ft/100)	Total			
	MEDIA ARTS CENTER	186	186											
	PERFORMANCE ARTS CENTER	65	251	6	0.9	200	1.8	15	50	1.1	0.55	2.35		
	ART BUILDING & ART GALLERY	71	322	6	1.25	200	2.5	15	30	1.25	0.375	2.875		
	STUDENT UNION	121	443	6	1.7	560	9.52	15	84	1.7	1.428	10.948		
	CAMPUS CENTER	215	658	8	0.8	120	0.96	15	18	0.8	0.144	1.104		
	HUMANITIES	71	729	8	1	160	1.6	15	24	1	0.24	1.84		
	BEHAVIORAL SCIENCE	59	788	8	1.15	80	0.92	15	12	1.15	0.138	1.058		
	CP to East Leg	0	788	10	1	135	1.35	15	20	1.9	0.19	1.54		
		788					18.65					3.065	21.715	

Conclusions:  
As calculated above, the central plant to Media Arts/Performance Arts Center via North-East Tunnel CHW supply is the furthest hydraulic route at 21.715 feet of head

Maximum Head Loss:	
North East Tunnel Supply	21.72
North East Tunnel Return	21.72
Central Plant (Chiller, Air Separator, etc.)	50
Furthest Building Contingency	30
<b>Total Estimated Head Loss</b>	<b>123.44</b>

This estimated Head Loss is less than CHW Site Pumps Head Available of 140 ft Head. Therefore, it will be OK with the proposed pipe sizing and its operation.

LOS ANGELES VALLEY COLLEGE – MEASURE J UTILITY MASTER PLAN  
APRIL 26, 2010

Los Angeles Valley College							Existing Conditions Estimations 2010			Estimated Expansion Thru 2011			Estimated Expansion Thru 2012			Estimated Expansion Thru 2013/2014			2011			2012/2013/2014			2014				
Building Name	Gross Square Footage	How Presently Served	Calculated Peak chilled water GPM Shown *	Calculated Cooling Design Peak Load based on GPM shown (tons) *	Cooling Design Peak Load (tons)	Peak Design Square Foot / Ton	Observed Diversity	Cooling Load w/ Observed Diversity (tons)	Square Foot / Ton	Observed Diversity	Cooling Load w/ Observed Diversity (tons)	Square Foot / Ton	Observed Diversity	Cooling Load w/ Observed Diversity (tons)	Square Foot / Ton	Observed Diversity	Cooling Load w/ Observed Diversity (tons)	Square Foot / Ton	GPM based on deg dT & diversified tons	Cooling Load w/ Observed Diversity (tons)	GPM based on deg dT & peak tons	* GPM based on deg dT & diversified tons w/ Observed Diversity (tons)	Cooling Load w/ Observed Diversity (tons)	* GPM based on deg dT & peak tons w/ Observed Diversity at N-E Leg w/north Loop	GPM based on deg dT at N-E Leg w/north Loop	Observed Diversity at N-E Leg w/north Loop	GPM based on deg dT at S-E Leg w/south Loop	Observed Diversity at S-E Leg w/south Loop	
FOREIGN LANGUAGE	16,130	West Tunnel	114	67	67	243	0.50	33	465	0.50	-	-	0.50	-	-	0.50	-	-	57	33	114								
ENGINEERING	24,145	West Tunnel	147	74	74	329	0.50	37	857	0.50	-	-	0.50	-	-	0.50	-	-	74	37	147								
SOUTH GYM	45,200	East Tunnel	144	96	96	471	0.50	48	942	0.50	-	-	0.50	-	-	0.50	-	-	82	48	165						82		
LIFE SCIENCE	20,660	East Tunnel	160	93	93	222	0.50	47	444	0.50	-	-	0.50	-	-	0.50	-	-	80	47	159						80		
MUSIC BUILDING & RECITAL HALL	16,441	West Tunnel	95	55	55	297	0.50	28	593	0.50	-	-	0.50	-	-	0.50	-	-	48	28	95								
ART BUILDING & ART GALLERY	18,965	East Tunnel	118	69	69	276	0.60	41	459	0.60	-	-	0.60	-	-	0.60	-	-	71	41	118				118	71			
BUSINESS & JOURNALISM	22,590	West Tunnel	182	106	106	213	0.50	53	426	0.60	-	-	0.60	-	-	0.60	-	-	91	53	182								
MATH & SCIENCES	19,611	West Tunnel	155	90	90	217	0.50	45	434	0.50	-	-	0.50	-	-	0.50	-	-	78	45	155								
PLANETARIUM	2,616				15	174	0.50			0.50	-	-	0.50	-	-	0.50	-	-	0	0	26								
BEHAVIORAL SCIENCE	13,700	East Tunnel	117	68	68	201	0.50	34	401	0.50	-	-	0.50	-	-	0.50	-	-	59	34	117				117	59			
HUMANITIES	19,400	East Tunnel	142	83	83	234	0.50	41	466	0.50	-	-	0.50	-	-	0.50	-	-	71	41	142				142	71			
MOTION PICTURE/ TV STUDIO	4,700	West Tunnel	47	27	27	171	0.50	14	343	0.50	-	-	0.50	-	-	0.50	-	-	24	14	47								
CAMPUS CENTER	83,553	East Tunnel	358	224	224	373	0.60	134	622	0.60	-	-	0.60	-	-	0.60	-	-	215	134	358				358	215			
M&O SHERIFF OFFICE	26,452				75	353	0.60			0.60			0.60			0.60			0	0	129								
ALLIED HEALTH SCIENCE	80,767	West Tunnel	692	595	595	136	0.75	446	181										699	446	892								
CENTRAL POWER PLANT	5,694				3		0.66	2	2,847										3	2	5								
NORTH GYM	37,983				65	581	0.50			0.50	-	-	0.50	-	-	0.50	-	-	0	0	112								
STUDENT SERVICES CENTER	40,186	West Tunnel	230	153	153	263	0.60	92	437	0.60			0.60			0.60			138	92	230								
CHILD DEVELOPMENT & FAMILY COMPLEX	25,904				77		0.60			0.60			0.60			0.60			0	0	132								
LIBRARY & ACADEMIC RESOURCE CENTER	82,922	West Tunnel	450	300	300	310	0.60			0.60	180	516	0.60			0.60			270	180	450								
SWIMMING POOLS					10											0.60						9	6	15					
MEDIA ARTS CENTER	62,000	East Tunnel	311	207	207	300	0.60			0.60			0.60			0.60	124	499				186	124	311	311	186			
NORTH GYM	37,983	East Tunnel	127	85	85								0.60	51	744								51					76	
ATHLETIC TRAINING FACILITY	18,000	East Tunnel	90	60	60	450	0.60			0.60			0.60	60	200	0.60						90	60	90				54	
PERFORMANCE ARTS CENTER	21,693	East Tunnel	108	72	72	301	0.60			0.60			0.60			0.60	43	502				65	43	108	108	65			
MULTI-PURPOSE PE / COMMUNITY SERVICES CENTER	30,000	East Tunnel	113	75	75	400	0.60			0.60			0.60			0.60	45	667				68	45	113				68	
ADMINISTRATION/CWCD	79,496	West Tunnel	399	266	266	299	0.60	65	1,223	0.60			0.60			0.60	140	568	98	65	399	210	140	399					
STUDENT UNION	53,538	East Tunnel	201	134	134	400	0.60			0.60			0.60			0.60	80	666				121	80	201	201	121			
Baseball Field House	10,000	East Tunnel	38	24	24	304				0.60			0.60	15	667							14	9	38				7	
<b>TOTAL</b>	<b>456,587</b>		<b>4,735</b>	<b>3,023</b>	<b>3,268</b>	<b>301</b>		<b>1,160</b>	<b>802</b>				<b>1,415</b>	<b>290</b>					<b>1,899</b>	<b>608</b>	<b>2,125</b>	<b>1,340</b>	<b>4,173</b>	<b>762</b>	<b>559</b>	<b>1,236</b>	<b>1,355</b>	<b>787</b>	<b>367</b>
				<b>245</b>									<b>TOTALS</b>									<b>2,887</b>	<b>1,699</b>	<b>5,409</b>					

NOTE:  
\* GPM shown from Infrastructure Chilled & Hot Water Diagram, M400.1

COLOR COORDINATION LEGEND			
BUILDINGS			
Green	Existing to Remain		
Yellow	Future to be Demolished		
Pink	Under Construction		
Light Blue	Gas Packaged Units		
Light Green	Gas/Electric Packaged Units		
Light Purple	Air Cooled Chiller Service		
CELLS			
White	Data entry cells		
Light Green	Calculated Cell		
Light Blue	Observed Diversity		

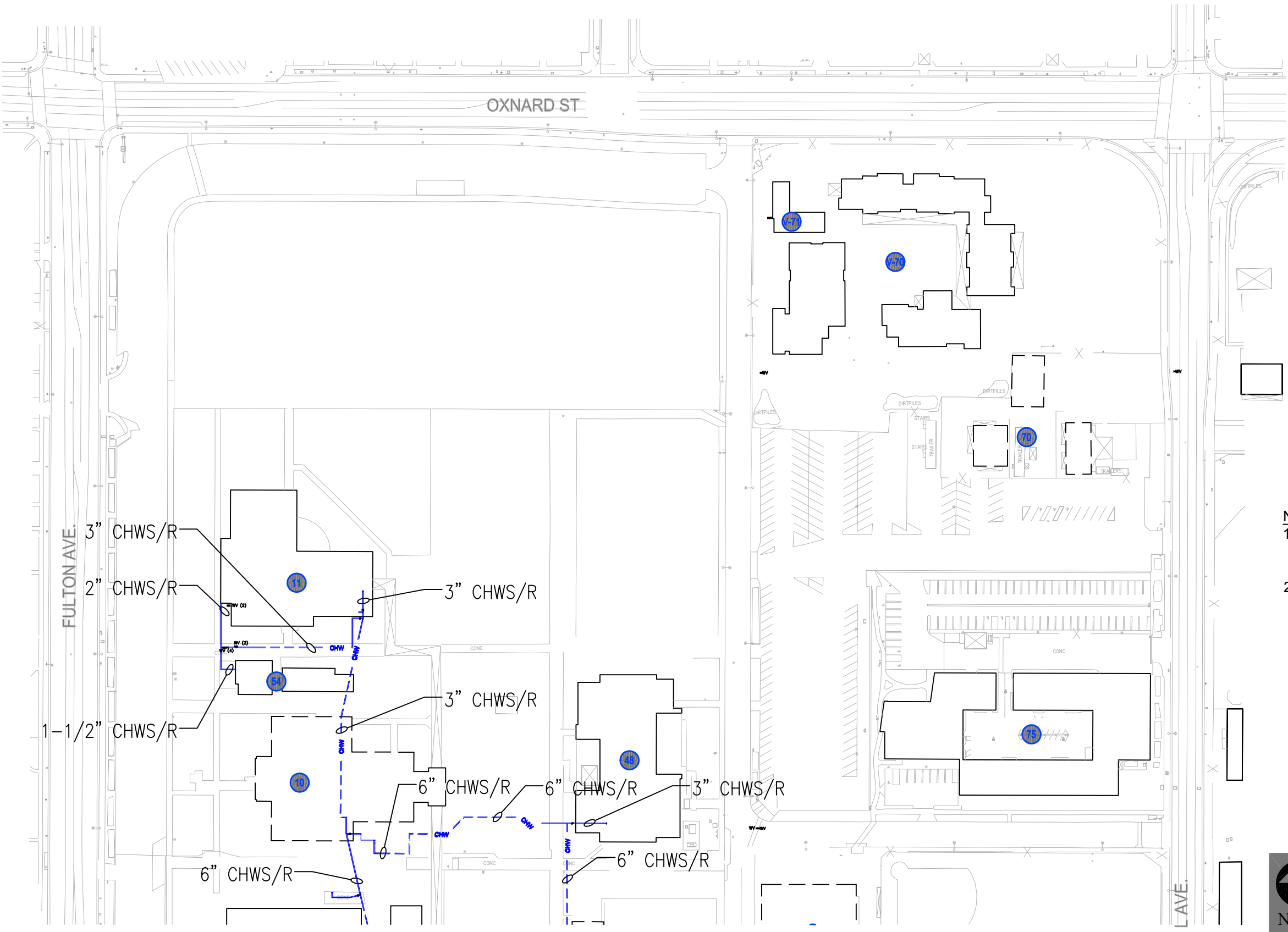
\* GPM VALUES SHOWN BOLD/RED ARE BASED ON 16 deg dT



North East Leg (Hydraulically longest Run)	Bldg. Branch	Branch Flow	In Flow (GPM)	Pipe Size (")	Loss ft/100	Pipe length (')	Loss (ft)	Fitting Loss (Elbows, Tees, Valves)				Total Loss (')	
								(%)	EQ. Ft	Loss Ft(Ft/100)	Total		
	MEDIA ARTS CENTER	186	186										
	PERFORMANCE ARTS CENTER	65	251	6	0.9	200	1.8	15	50	1.1	0.55	2.35	
	ART BUILDING & ART GALLERY	71	322	6	1.25	200	2.5	15	30	1.25	0.375	2.875	
	STUDENT UNION	121	443	6	1.7	560	9.52	15	84	1.7	1.428	10.948	
	CAMPUS CENTER	215	658	6	0.8	120	0.96	15	18	0.8	0.144	1.104	
	HUMANITIES	71	729	6	1	180	1.6	15	24	1	0.24	1.84	
	BEHAVIORAL SCIENCE	59	788	8	1.15	80	0.92	15	12	1.15	0.138	1.058	
	CP to East Leg	0	788	10	1	135	1.35	15	20	1.9	0.19	1.54	
							<b>18.65</b>					<b>3.065</b>	<b>21.715</b>

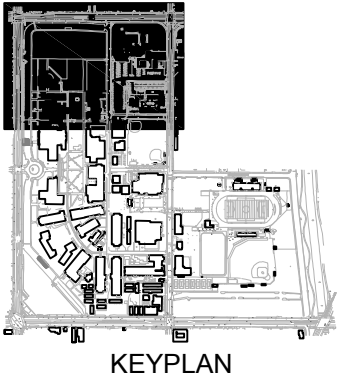
Conclusions:  
As calculated above, the central plant to Media Arts/Performance Arts Center via North-East Tunnel CHW supply is the furthest hydraulic route at 21.715 feet of head

Maximum Head Loss:	
North East Tunnel Supply	21.72
North East Tunnel Return	21.72
Central Plant (Chiller, Air Separator, etc.)	50
Furthest Building Contingency	30
<b>Total Estimated Head Loss</b>	<b>123.44</b>

This estimated Head Loss is less than CHW Site Pumps Head Available of 140 ft Head.  
Therefore, it will be OK with the proposed pipe sizing and its operation.



- LEGEND:**
-  EXISTING BUILDING
  -  EXISTING CHW LINE

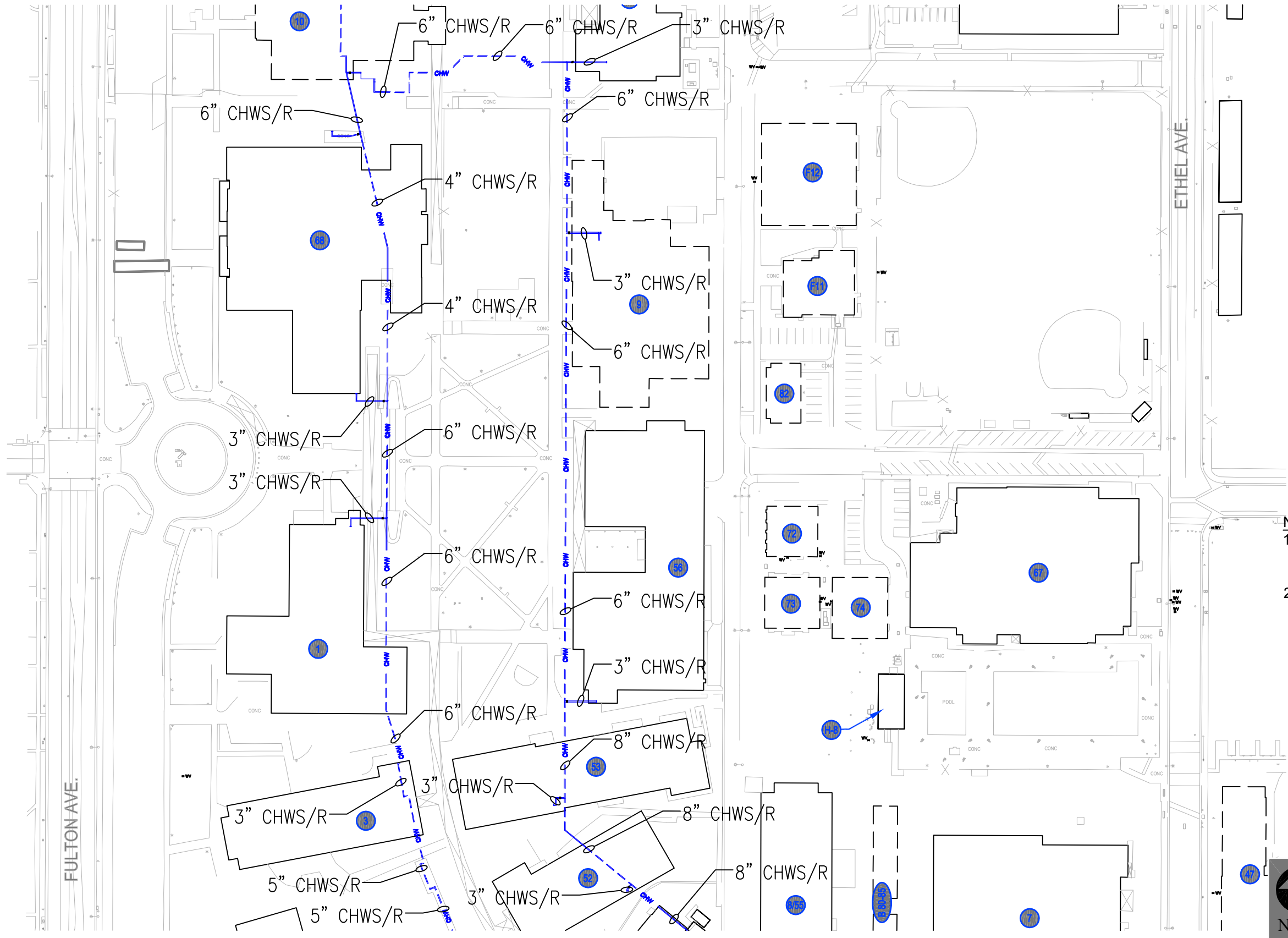




- NOTE:**
1. REFER TO TABLES ES-1 AND ES-2 FOR BUILDING NAMES.
  2. THE INFORMATION SHOWN HEREON IS A GRAPHICAL DEPICTION OF THE EXISTING CAMPUS UTILITY SYSTEMS. THE SITE SURVEY AND INFRASTRUCTURE STUDIES EXISTING UTILITY PLANS PREPARED UNDER SEPARATE COVER SHALL BE REFERENCED FOR DETAILED INFORMATION

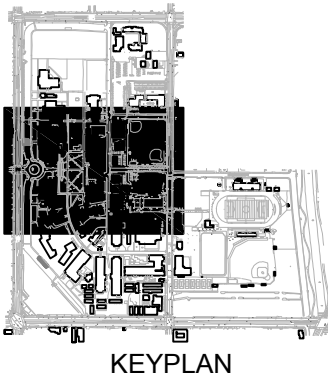


FIGURE 8a  
 EXISTING CONDITIONS UTILITY MAP - CHILLED WATER

*(Page Intentionally Left Blank)*



**LEGEND:**  
 EXISTING BUILDING  
 EXISTING CHW LINE

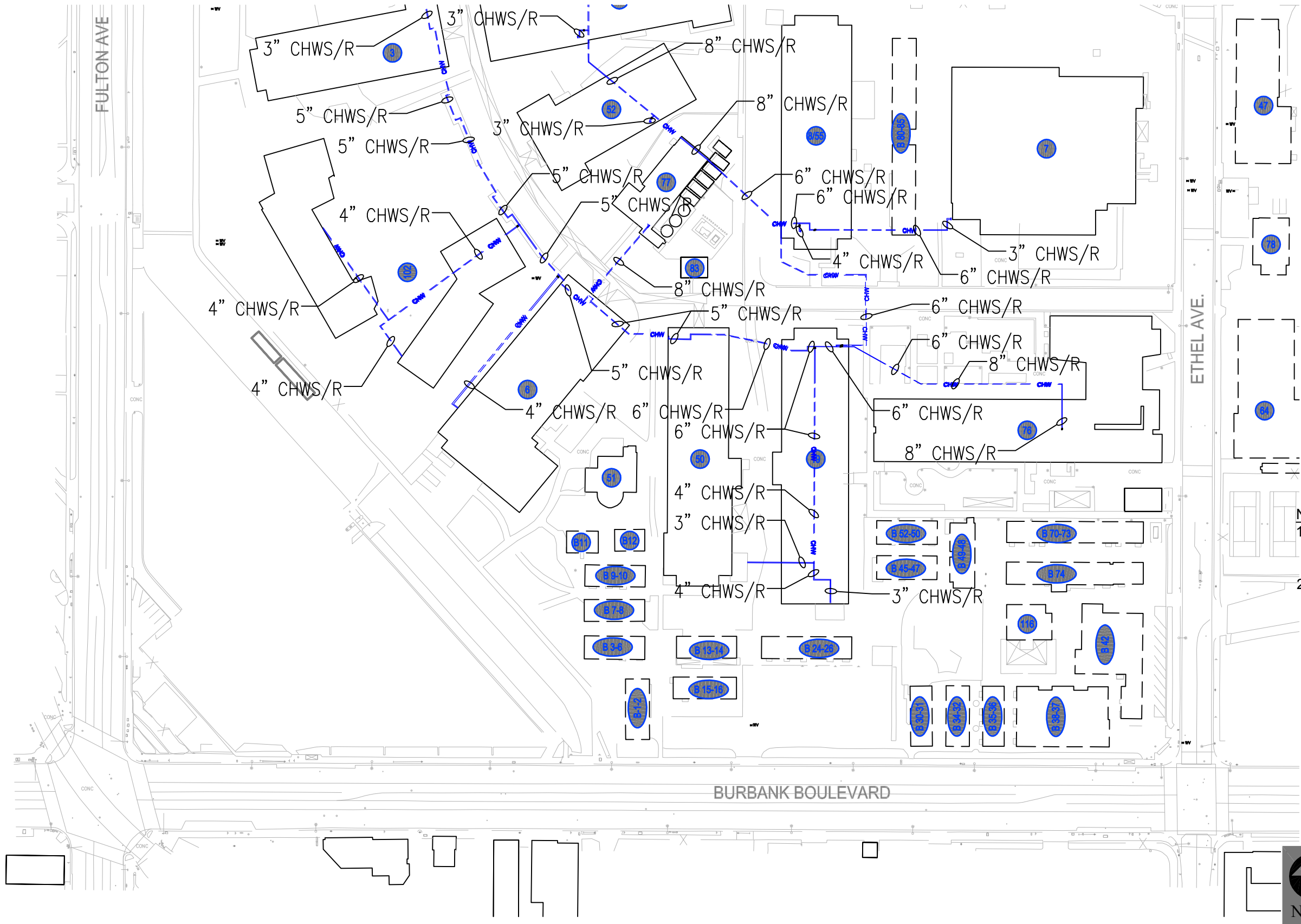


**NOTE:**  
 1. REFER TO TABLES ES-1 AND ES-2 FOR BUILDING NAMES.  
 2. THE INFORMATION SHOWN HEREON IS A GRAPHICAL DEPICTION OF THE EXISTING CAMPUS UTILITY SYSTEMS. THE SITE SURVEY AND INFRASTRUCTURE STUDIES EXISTING UTILITY PLANS PREPARED UNDER SEPARATE COVER SHALL BE REFERENCED FOR DETAILED INFORMATION

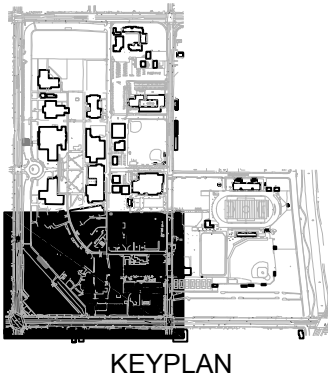


FIGURE 8b  
 EXISTING CONDITIONS UTILITY MAP - CHILLED WATER

*(Page Intentionally Left Blank)*



**LEGEND:**  
 EXISTING BUILDING  
 EXISTING CHW LINE

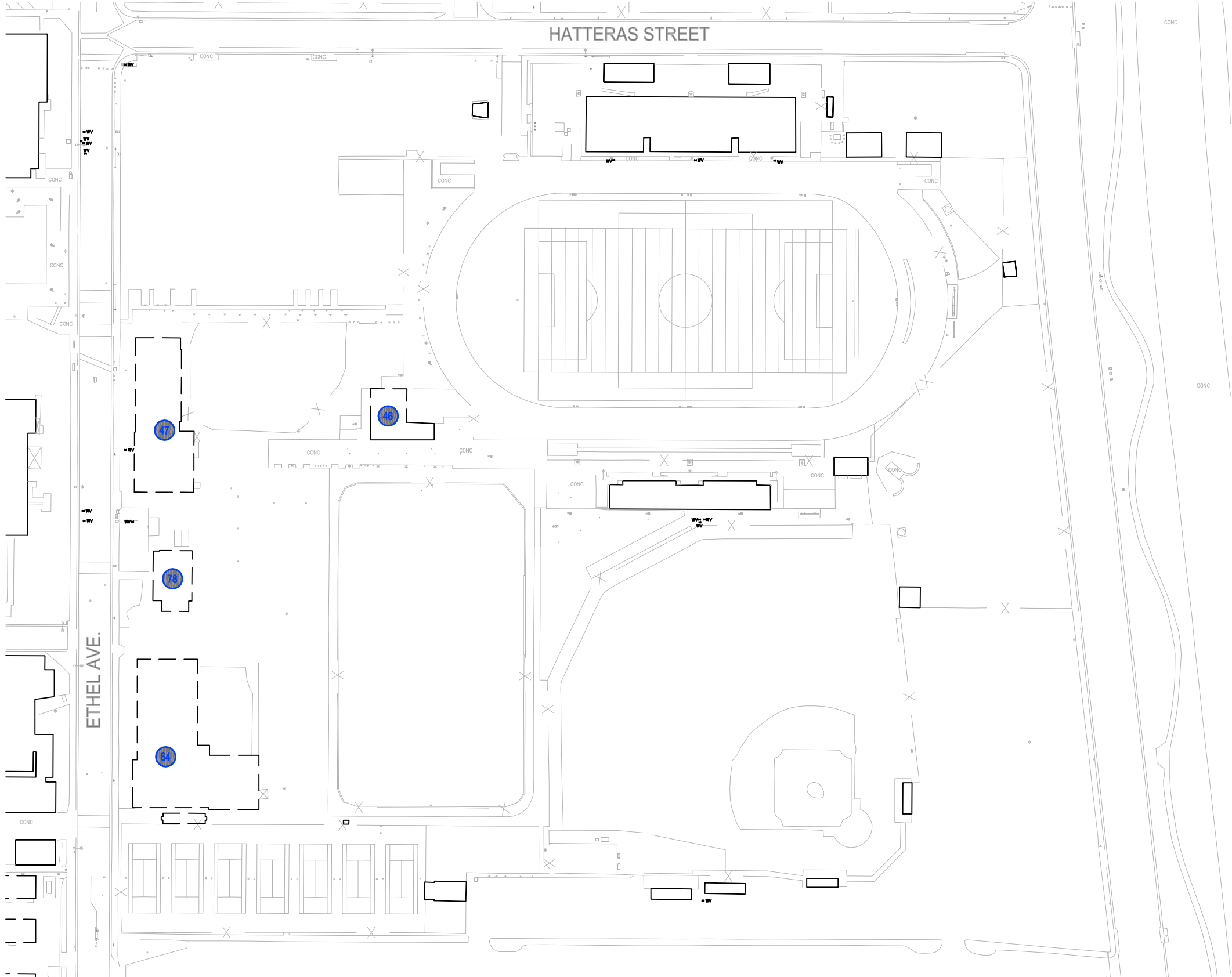




**NOTE:**  
 1. REFER TO TABLES ES-1 AND ES-2 FOR BUILDING NAMES.  
 2. THE INFORMATION SHOWN HEREON IS A GRAPHICAL DEPICTION OF THE EXISTING CAMPUS UTILITY SYSTEMS. THE SITE SURVEY AND INFRASTRUCTURE STUDIES EXISTING UTILITY PLANS PREPARED UNDER SEPARATE COVER SHALL BE REFERENCED FOR DETAILED INFORMATION

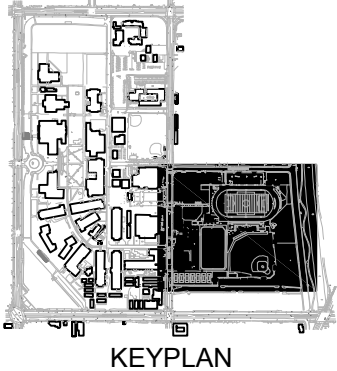


FIGURE 8c  
 EXISTING CONDITIONS UTILITY MAP - CHILLED WATER

*(Page Intentionally Left Blank)*



**LEGEND:**  
 EXISTING BUILDING  
 EXISTING CHW LINE

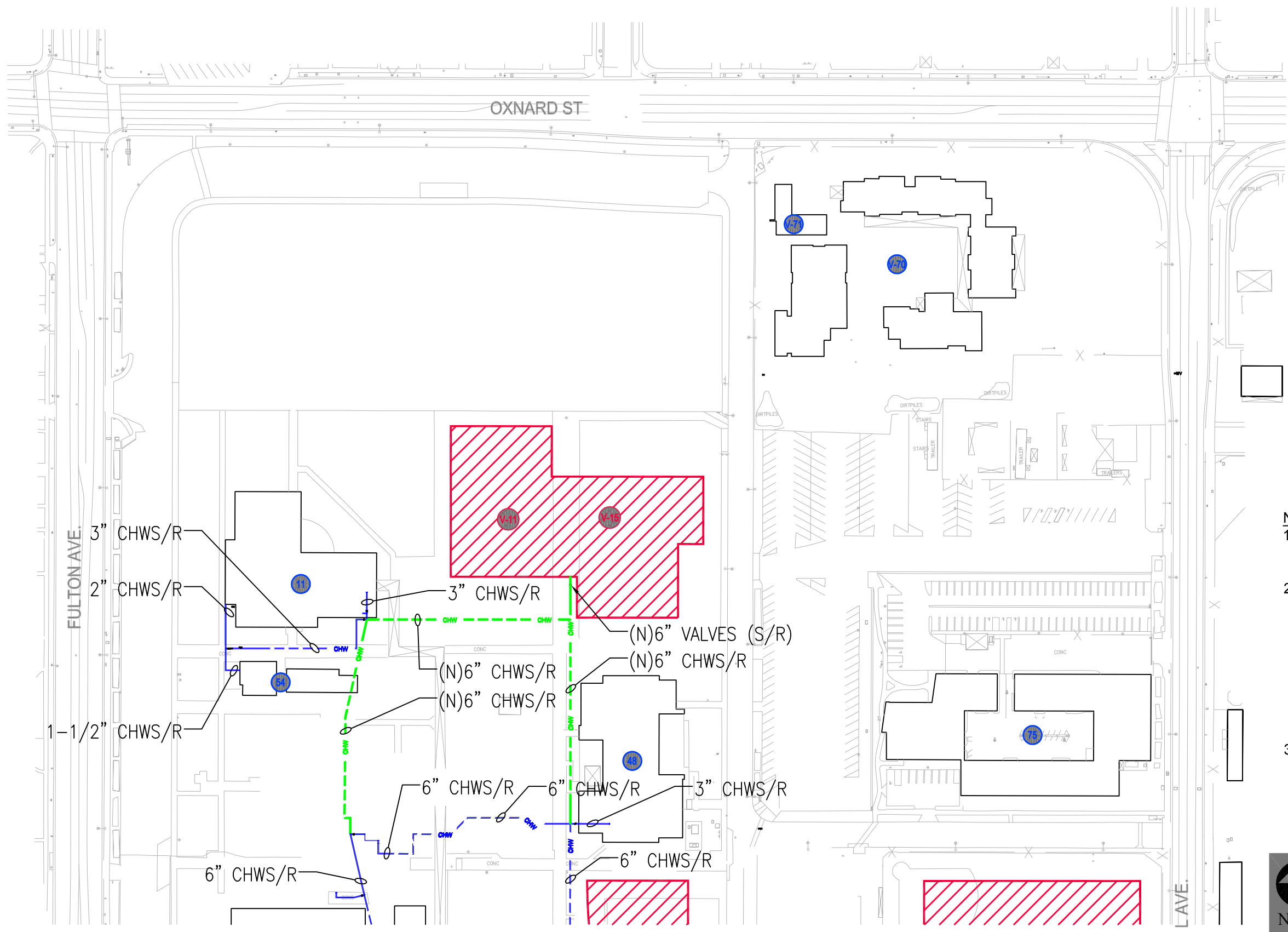


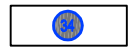



**NOTE:**  
 1. REFER TO TABLES ES-1 AND ES-2 FOR BUILDING NAMES.  
 2. THE INFORMATION SHOWN HEREON IS A GRAPHICAL DEPICTION OF THE EXISTING CAMPUS UTILITY SYSTEMS. THE SITE SURVEY AND INFRASTRUCTURE STUDIES EXISTING UTILITY PLANS PREPARED UNDER SEPARATE COVER SHALL BE REFERENCED FOR DETAILED INFORMATION

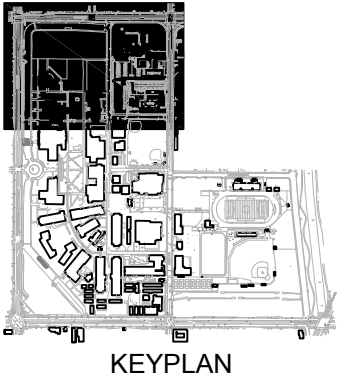


FIGURE 8d  
 EXISTING CONDITIONS UTILITY MAP - CHILLED WATER

*(Page Intentionally Left Blank)*



- LEGEND:**
-  EXISTING BUILDING
  -  PROPOSED MEASURE J BUILDING
  -  EXISTING CHW LINE
  -  PROPOSED CHW LINE



- NOTE:**
1. REFER TO TABLES ES-1 AND ES-2 FOR BUILDING NAMES.
  2. THE INFORMATION SHOWN HEREON IS A GRAPHICAL DEPICTION OF THE EXISTING CAMPUS UTILITY SYSTEMS. THE SITE SURVEY AND INFRASTRUCTURE STUDIES EXISTING UTILITY PLANS PREPARED UNDER SEPARATE COVER SHALL BE REFERENCED FOR DETAILED INFORMATION
  3. FUTURE CONDITIONS UTILITY MAPS SHOW ONLY THE DISPOSITION OF FUTURE BUILDINGS. REFER TO FIGURE 0e-MEASURE J MASTER PLAN SUMMARY FOR COMPLETE LAYOUT OF FUTURE CONDITIONS.



FIGURE 8e  
 FUTURE CONDITIONS UTILITY MAP - CHILLED WATER

*(Page Intentionally Left Blank)*

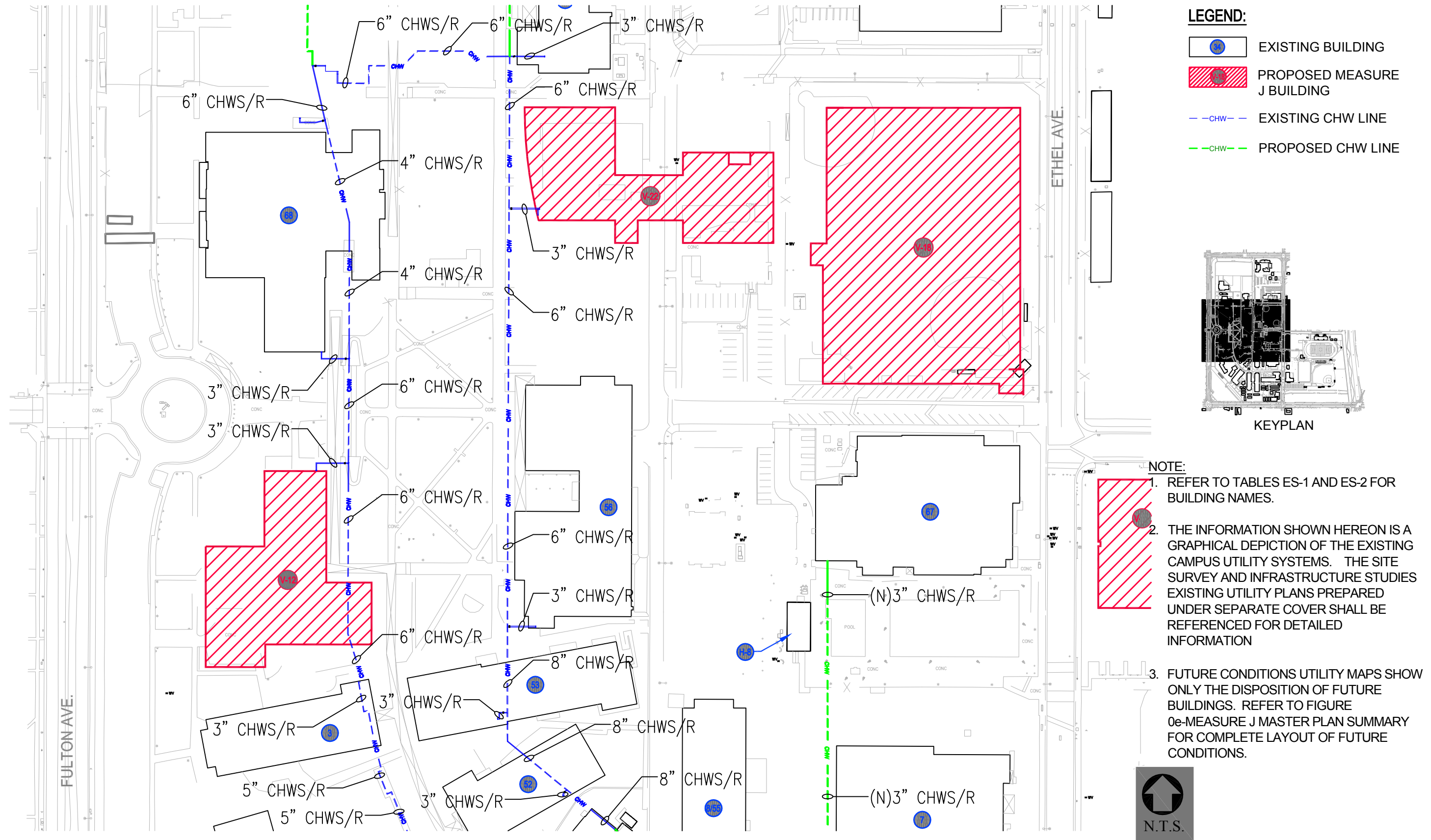
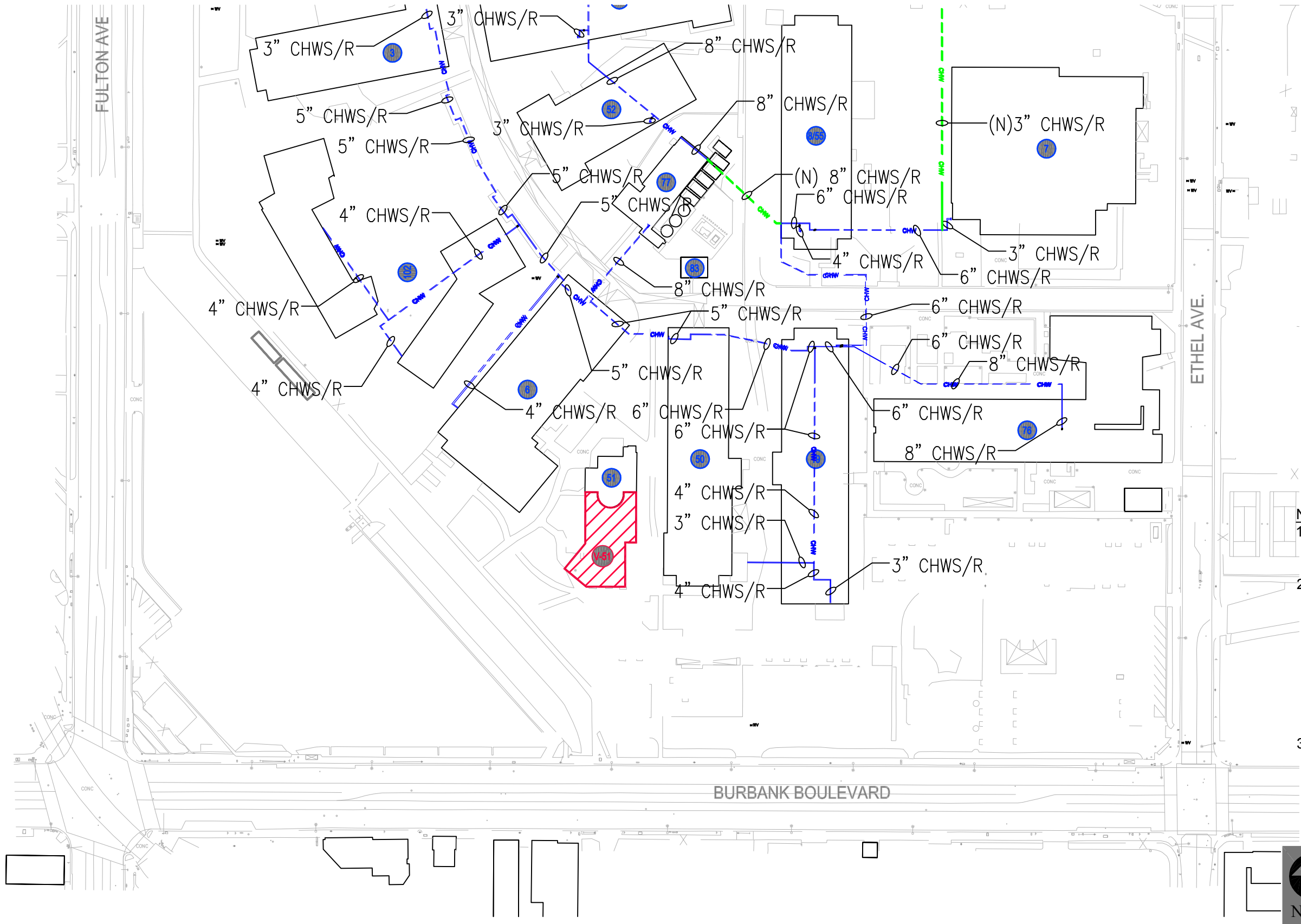




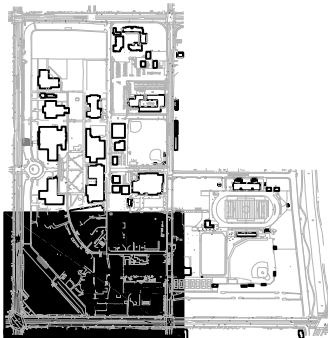


FIGURE 8f  
 FUTURE CONDITIONS UTILITY MAP - CHILLED WATER

*(Page Intentionally Left Blank)*



- LEGEND:**
-  EXISTING BUILDING
  -  PROPOSED MEASURE J BUILDING
  -  EXISTING CHW LINE
  -  PROPOSED CHW LINE



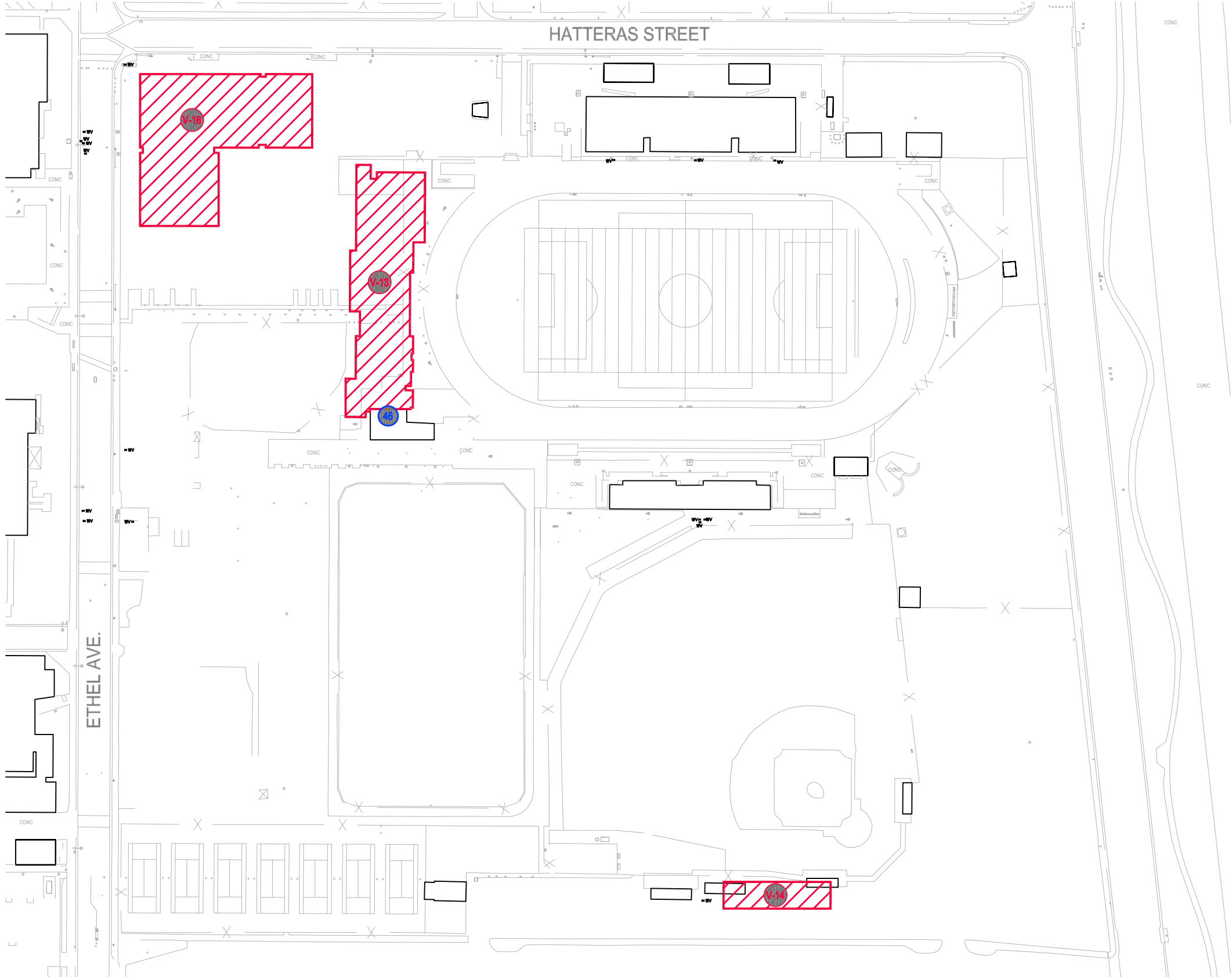
KEYPLAN





- NOTE:**
1. REFER TO TABLES ES-1 AND ES-2 FOR BUILDING NAMES.
  2. THE INFORMATION SHOWN HEREON IS A GRAPHICAL DEPICTION OF THE EXISTING CAMPUS UTILITY SYSTEMS. THE SITE SURVEY AND INFRASTRUCTURE STUDIES EXISTING UTILITY PLANS PREPARED UNDER SEPARATE COVER SHALL BE REFERENCED FOR DETAILED INFORMATION
  3. FUTURE CONDITIONS UTILITY MAPS SHOW ONLY THE DISPOSITION OF FUTURE BUILDINGS. REFER TO FIGURE 0e-MEASURE J MASTER PLAN SUMMARY FOR COMPLETE LAYOUT OF FUTURE CONDITIONS.

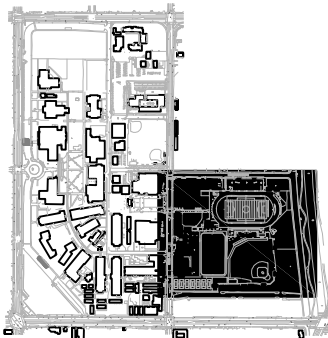


FIGURE 8g  
 FUTURE CONDITIONS UTILITY MAP - CHILLED WATER

*(Page Intentionally Left Blank)*



- LEGEND:**
-  EXISTING BUILDING
  -  PROPOSED MEASURE J BUILDING
  -  EXISTING CHW LINE
  -  PROPOSED CHW LINE



KEYPLAN

- NOTE:**
1. REFER TO TABLES ES-1 AND ES-2 FOR BUILDING NAMES.
  2. THE INFORMATION SHOWN HEREON IS A GRAPHICAL DEPICTION OF THE EXISTING CAMPUS UTILITY SYSTEMS. THE SITE SURVEY AND INFRASTRUCTURE STUDIES EXISTING UTILITY PLANS PREPARED UNDER SEPARATE COVER SHALL BE REFERENCED FOR DETAILED INFORMATION
  3. FUTURE CONDITIONS UTILITY MAPS SHOW ONLY THE DISPOSITION OF FUTURE BUILDINGS. REFER TO FIGURE 0e-MEASURE J MASTER PLAN SUMMARY FOR COMPLETE LAYOUT OF FUTURE CONDITIONS.



FIGURE 8h  
 FUTURE CONDITIONS UTILITY MAP - CHILLED WATER

*(Page Intentionally Left Blank)*

**SECTION 9 – HEATING HOT WATER SYSTEM**

**9.1 SYSTEM DESCRIPTION**

Campus heating hot water is supplied by the central plant located near south end of Campus Drive adjacent to the Life Science Building. There are two pairs of underground heating hot water supply and return branches serving the campus from the two(2) 6” heating hot water supply and return mains in the central plant building: west tunnel loop and east tunnel loop. The west tunnel loop is served by 6” HHW S & R pipes. And the east tunnel loop is also served by 6” HHW S & R pipes.

**WEST TUNNEL - North West / South West Tunnel Loop**

The 6” HHW S & R pipes serving the west tunnel loop run out to south west end of Campus Drive and follow through student walkway to the northwest of the campus. There are two pairs of 3” and 2.5” HHW S & R buried stub-outs with isolation valves that branch west towards the new upcoming Library/Academic Resource Center (LARC) and Student Services Center Buildings respectively for their hook-up services. From northwest corner of the west tunnel, the existing 1.5” HHW S & R pipes through wall to Music Building. Additionally, 1.5” HHW S & R pipes through tunnel wall and connected for Music Building for new Music Building Annex and the existing Motion Picture Building. The existing 1.5” HHW S & R pipes through wall to Theater Arts Building. The existing 2” HHW S & R pipes through wall to Administration Building. The existing 1.5” HHW S & R pipes through wall to Foreign Language Building. The existing 2” HHW S & R pipes in trench through wall to Engineering Building. The existing 2” HHW S & R pipes through wall to Math, Earth Science Building. The existing 2” HHW S & R pipes through wall to Business & Journalism Building. At this point there are 6” HHW S & R buried stub-outs with isolation valves toward the East direction and then routed in trench between the south tie-in loop and the Allied Health Science Building.

**EAST TUNNEL - North East / South East Tunnel Loop**

The 6” HHW S & R pipes serving the east tunnel loop run out to south east end of Campus Drive and follow through student walkway to the northeast of the campus. From the northeast corner of the east tunnel, the existing 1.5” and 2” HHW S & R pipes through tunnel wall to Art and Cafeteria Buildings respectively. After those buildings, the existing 3” and 1.5” HHW S & R pipes through tunnel wall to Campus Center and Humanities Buildings respectively. Prior to central plant, the existing 1.5” HHW S & R pipes through tunnel wall to Behavioral Sciences Building. After central plant, the existing 2” and 2.5” HHW S & R pipes through tunnel wall to Life Sciences and South Gym Buildings respectively.

**9.2 METHODOLOGY**

The size of the distribution piping mains and branches for the Los Angeles Valley College – Measure J Utility Master Plan were studied using the following methodologies:

Information regarding the size, usage and heating hot water demands of each building or complex which will utilize the campus heating hot water system to meet their heating needs was compiled through various sources. Much of the information regarding older campus buildings was provided by the campus in the form of historical documentation, as built drawings. Some information was obtained using documentation from a previous energy retrofit project. Several buildings were based on current proposed or actual construction documents. The balance was determined by applying accepted engineering practice rule of thumb factors based on individual building occupancy and usage type.

When known actual installed MBH was used for the heating design peak load (MBH). Where this information was not known, the building area was multiplied by an accepted square foot/ton factor. This factor was determined based on a combination of experience, good engineering design practice and referenced material from the 2009 ASHRAE Fundamentals.

An average diversity of 0.83 was used as a basis for determining the required equipment capacities and distribution piping sizes. This is consistent with the diversity used for the central plant expansion project which is currently completed. This assumption means 83% diversity for the total connected load will require heating hot water at any one time for the building including Allied Health Science. Based on extensive experience in the design of campus central plant systems, an average diversity of 83% is a conservative basis of design for the Los Angeles Valley College campus.

Having determined the diversified tonnage for each building or complex of buildings to be served by the central plant a diversified GPM was calculated. Diversified GPM is calculated using the formula;

$$Q = \text{Load} / (500 * \Delta T)$$

Where

- Load = diversified MBH x 1,000
- Q=flow rate, GPM
- ΔT=temperature increase or decrease, °F

**9.3 ANALYSIS OF EXISTING SYSTEM**

The current average heating hot water temperature difference, ΔT (°F), for this campus is 40°F. The calculated GPM shown on the Utility Master Plan Heating Hot Water System table assumes all existing buildings and all buildings scheduled to be operational by the end of 2010 will use the current average chilled water temperature difference of 40°F ΔT in sizing the cooling coils for those buildings. Buildings proposed to be operational in 2012 and 2013 shall utilize a 40°F ΔT in sizing the building cooling coils.

Based on the current load estimate in the heating load calculation, there will be no issue for campus heating demand.

**9.4 ANALYSIS OF FUTURE NEEDS**

The total estimated heating hot water load and flow requirements to serve the future campus were broken into three (3) phases. The first phase includes buildings currently on the campus heating hot water system and buildings currently under construction and assumed to be operational by the end of 2012. The second phase adds proposed buildings assumed to be in operation by the end of 2013. The third phase adds the proposed buildings assumed to be operational by the end of 2014. In addition, buildings to be demolished were removed from the system as indicated in the table. Completed construction for proposed buildings is based on the LAVC proposed campus buildings list provided by the Campus.

Having determined the required heating hot water system GPM through the year 2014, a hydraulic flow spreadsheet calculation was constructed to analyze the existing underground chilled water distribution piping and pumping systems. The spreadsheet calculation was constructed using known parameters with regards to location of the central plant in relationship to each building. The routing and material of the distribution piping to each building was based on information obtained using historical documentation and a site survey performed by P2S Engineering personnel. Each building was then set at its diversified GPM to determine the hydraulically most remote building. At completion of the 2013 buildings the Media Art/Performance Arts Center Buildings are the hydraulically remote building on the campus heating hot water system. In the final spreadsheet calculation of the Media Art/Performance Arts Center Buildings coil is set to fully open to simulate the building peak condition. This allows the spreadsheet calculation to determine the pressure losses and velocities through the piping system when there is maximum flow to the hydraulically most remote buildings like the Media Art/Performance Arts Center. This data was used to determine where piping and distribution pumping modifications would be warranted and as required.

**9.5 FINDINGS AND RECOMMENDATIONS**

The recommendations have been categorized into three priority levels. Descriptions of each priority level are provided in the executive summary of this report.

The hydraulic flow spreadsheet calculation was used to evaluate the heating hot water piping system based on the following criteria: maximum velocity of 6 ft/sec in piping 6” and below, maximum velocity of 10 ft/sec in piping above 6” and a maximum variable primary pump head of 110 feet. Based on these criteria we have the following piping recommendations:

Priority 1

- Provide the 3” main in North East Tunnel to serve the proposed Media Art and Performance Arts Centers.

The existing north east tunnel branch is currently serving the Art Building with the 3” branch main. The extension of this 3” line size

will be sufficient to serve the 75 GPM of peak load flow requirement for the Media Art/Performance Arts Center. The resulting fluid velocity would approach 3.5 ft/sec. By extending the existing 3" north east tunnel end branch from the Art Building to the Media Art/Performance Arts Center is recommended. This would allow for additional flow capacity in the future at this side of the campus.

- Replace the existing 2" loop at the north-west tunnel end branch with the new 3" piping to improve the current operational issue per LAVC Facility Department.

Priority 2

- Completing the 3" piping bridge connection loop between north-west tunnel end branches to north east tunnel end branch is recommended to enhance the system flexibility in the event additional development or building renovation in this part of the campus occurs in the future.

- Replace the existing 2-pipe system at the Life Science Building with the new 4-pipe system to improve the current operational issue per LAVC Facility Department.
- Provide the new 2" HHW S&R connections to the existing North Gym Building from Central Plant per LAVC Facility Department.
- Replace the existing 3" and 2.5" HHW S&R loops at the south-east tunnel header and fork branches with the new 4" piping to connect North Gym from Central Plant and plus if when the decision has made to connect the Athletic Center Buildings from Central Plant per LAVC Facility Department.

Priority 3

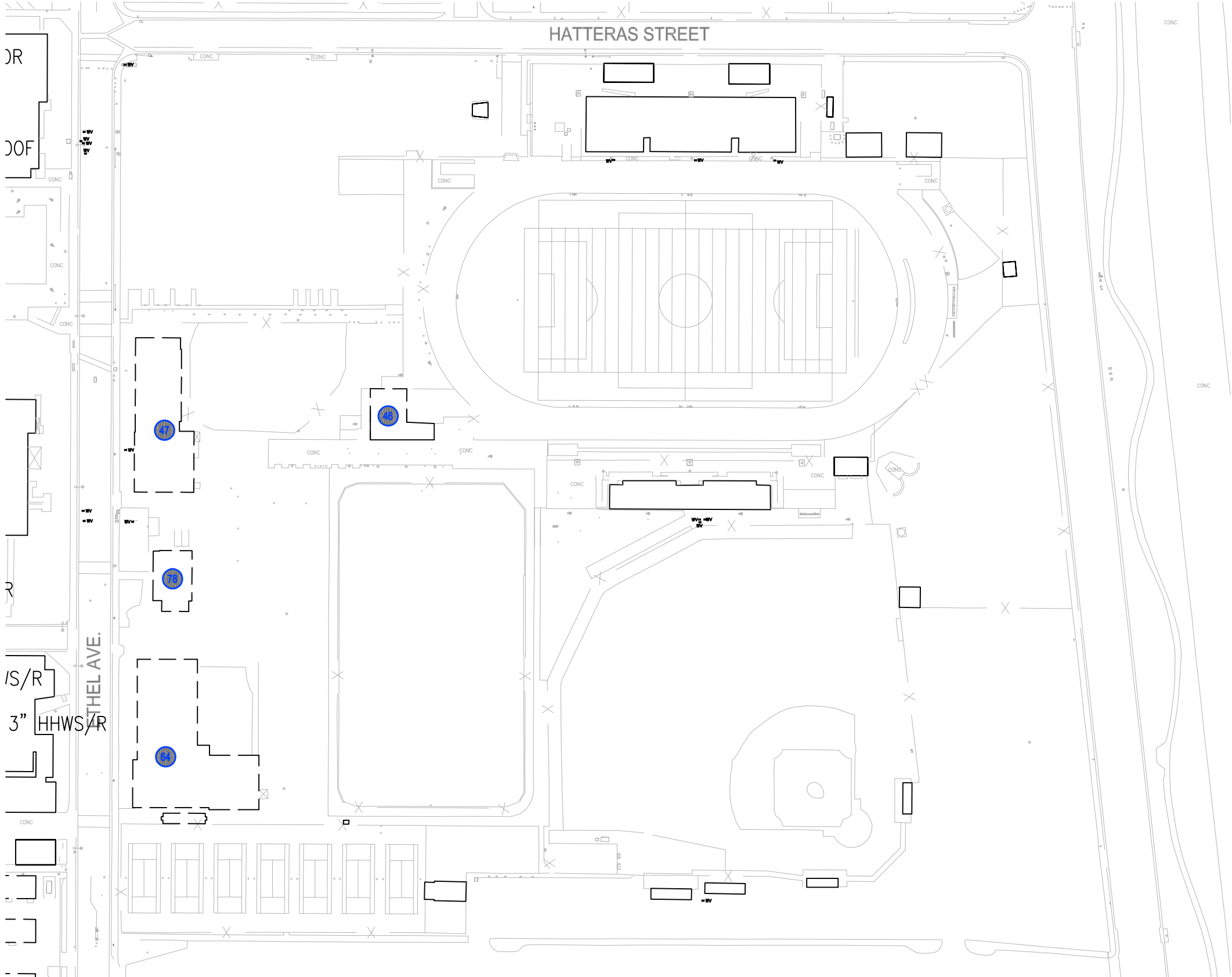
- Due to the remoteness and its associated cost for piping installation from central plant, Athletic Training Facility and Multi-Purpose PE/Community Services Center will have a satellite central plant to



serve their needs for heating hot water or staying with natural gas heating like other remote building. It is recommended that the feasibility study is conducted to investigate the option of Micro-turbine technology for the buildings' heating requirements.

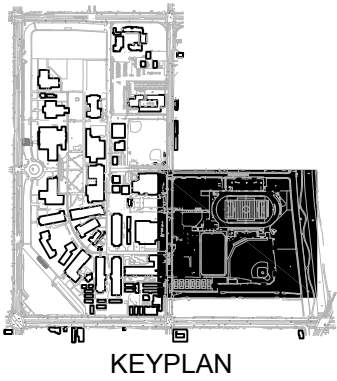
- Due to the remoteness and its associated cost for piping installation from central plant, Child Development & Family Complex and Family Resource Center, and M&O-Sheriff Office will have a satellite central plant to serve their needs for heating hot water or staying with current natural gas heating. It is recommended that the feasibility study is conducted to investigate the option of Micro-turbine technology for the buildings' heating requirements.







**LEGEND:**  
 EXISTING BUILDING  
 EXISTING HHW LINE

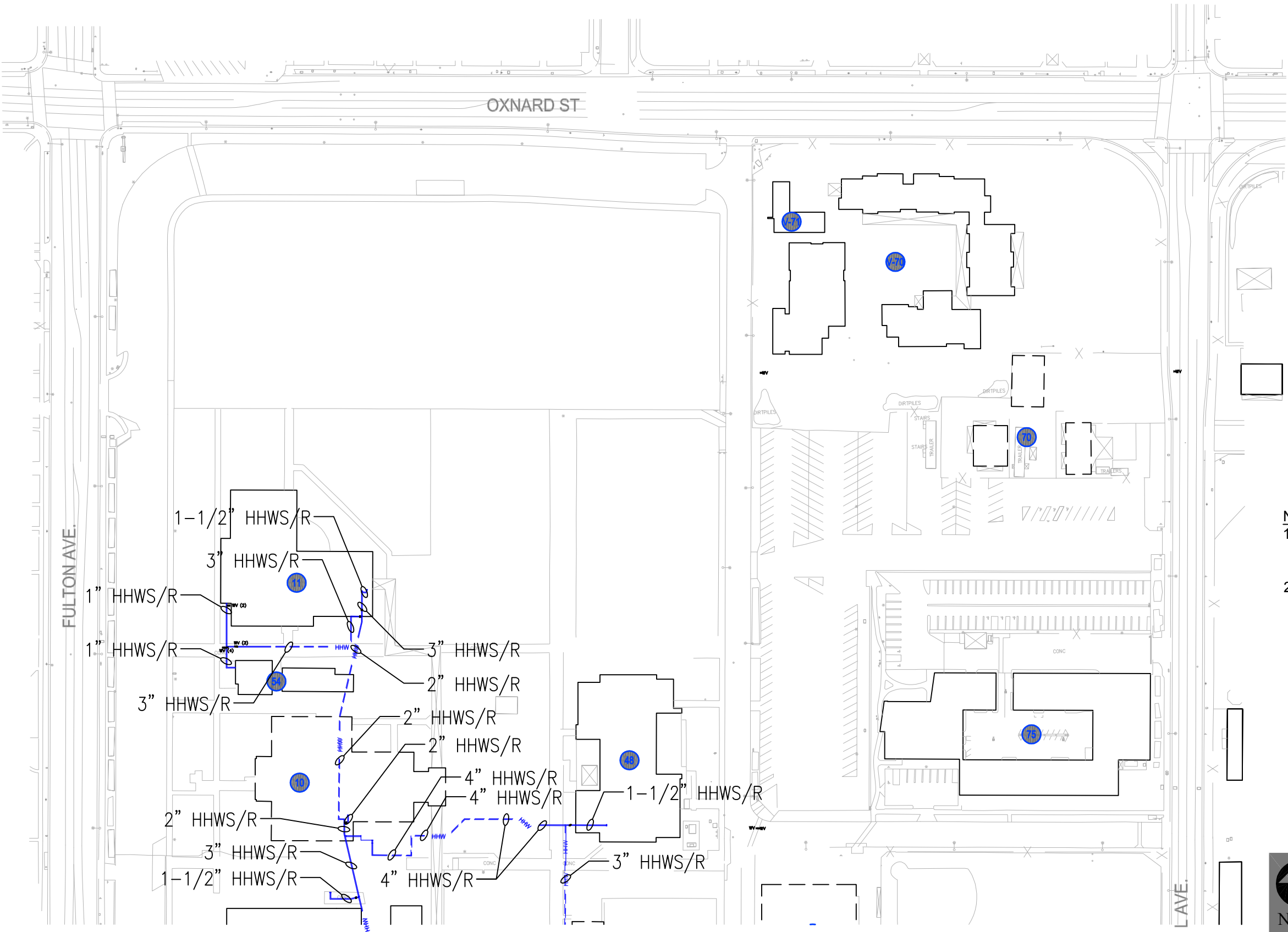




**NOTE:**  
 1. REFER TO TABLES ES-1 AND ES-2 FOR BUILDING NAMES.  
 2. THE INFORMATION SHOWN HEREON IS A GRAPHICAL DEPICTION OF THE EXISTING CAMPUS UTILITY SYSTEMS. THE SITE SURVEY AND INFRASTRUCTURE STUDIES EXISTING UTILITY PLANS PREPARED UNDER SEPARATE COVER SHALL BE REFERENCED FOR DETAILED INFORMATION

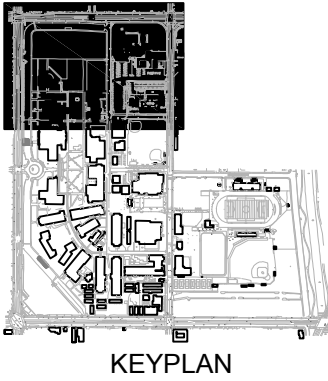


FIGURE 9d  
 EXISTING CONDITIONS UTILITY MAP - HOT WATER

*(Page Intentionally Left Blank)*



- LEGEND:**
-  EXISTING BUILDING
  -  EXISTING HHW LINE



- NOTE:**
1. REFER TO TABLES ES-1 AND ES-2 FOR BUILDING NAMES.
  2. THE INFORMATION SHOWN HEREON IS A GRAPHICAL DEPICTION OF THE EXISTING CAMPUS UTILITY SYSTEMS. THE SITE SURVEY AND INFRASTRUCTURE STUDIES EXISTING UTILITY PLANS PREPARED UNDER SEPARATE COVER SHALL BE REFERENCED FOR DETAILED INFORMATION



FIGURE 9a  
 EXISTING CONDITIONS UTILITY MAP - HOT WATER

*(Page Intentionally Left Blank)*

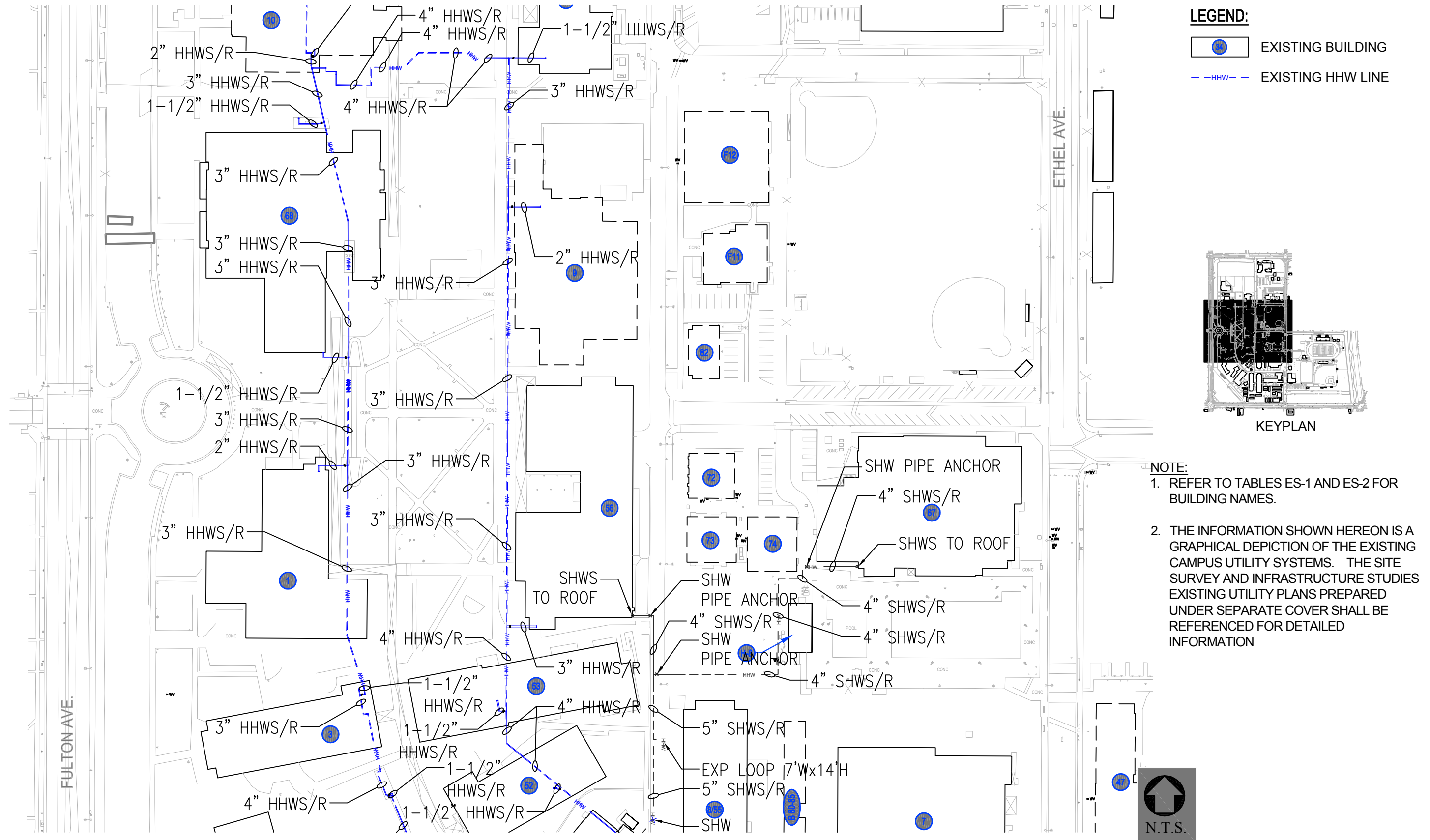
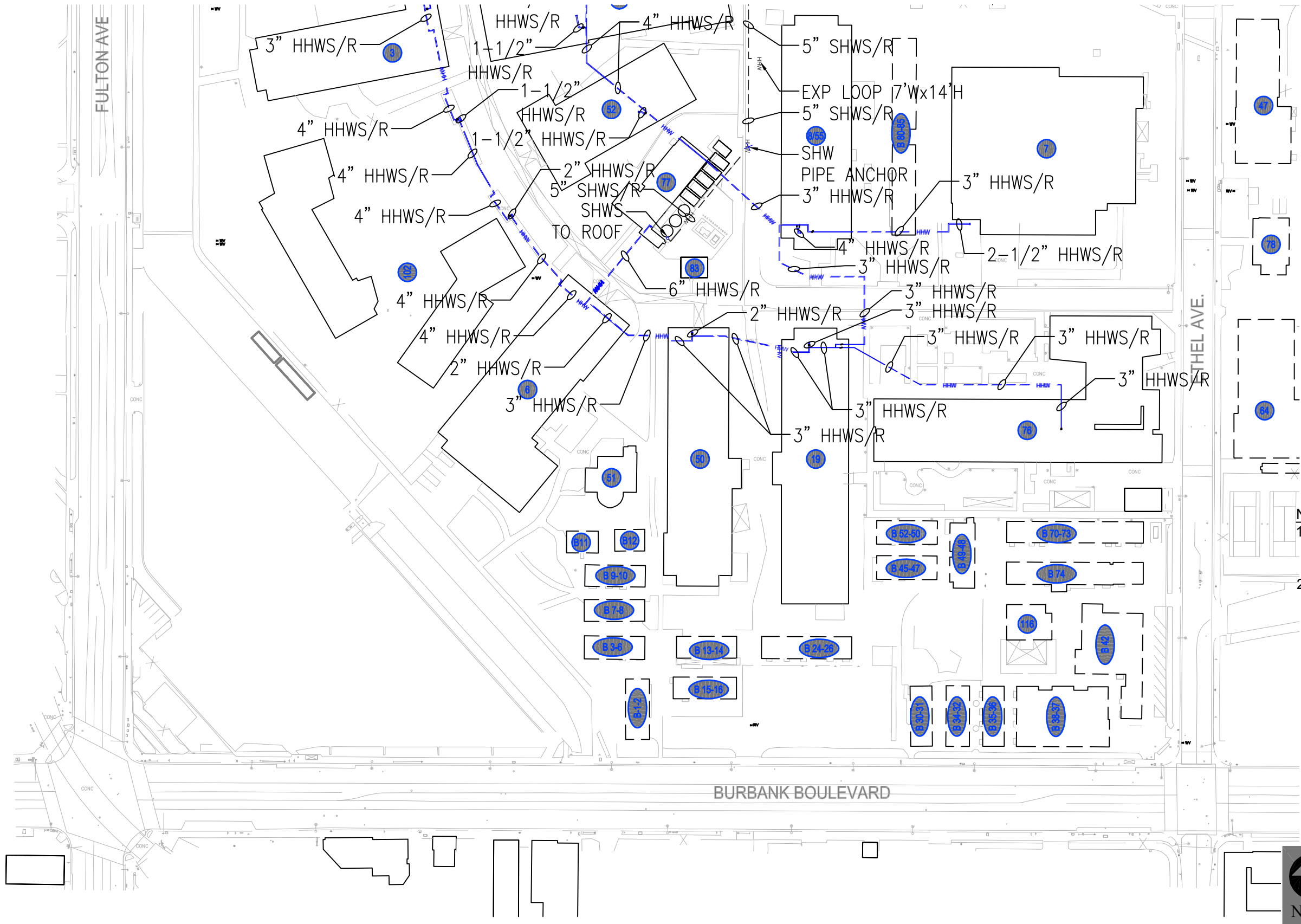


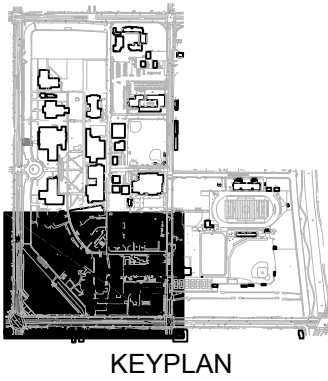


FIGURE 9b  
 EXISTING CONDITIONS UTILITY MAP - HOT WATER

*(Page Intentionally Left Blank)*



**LEGEND:**  
 EXISTING BUILDING  
 EXISTING HHW LINE

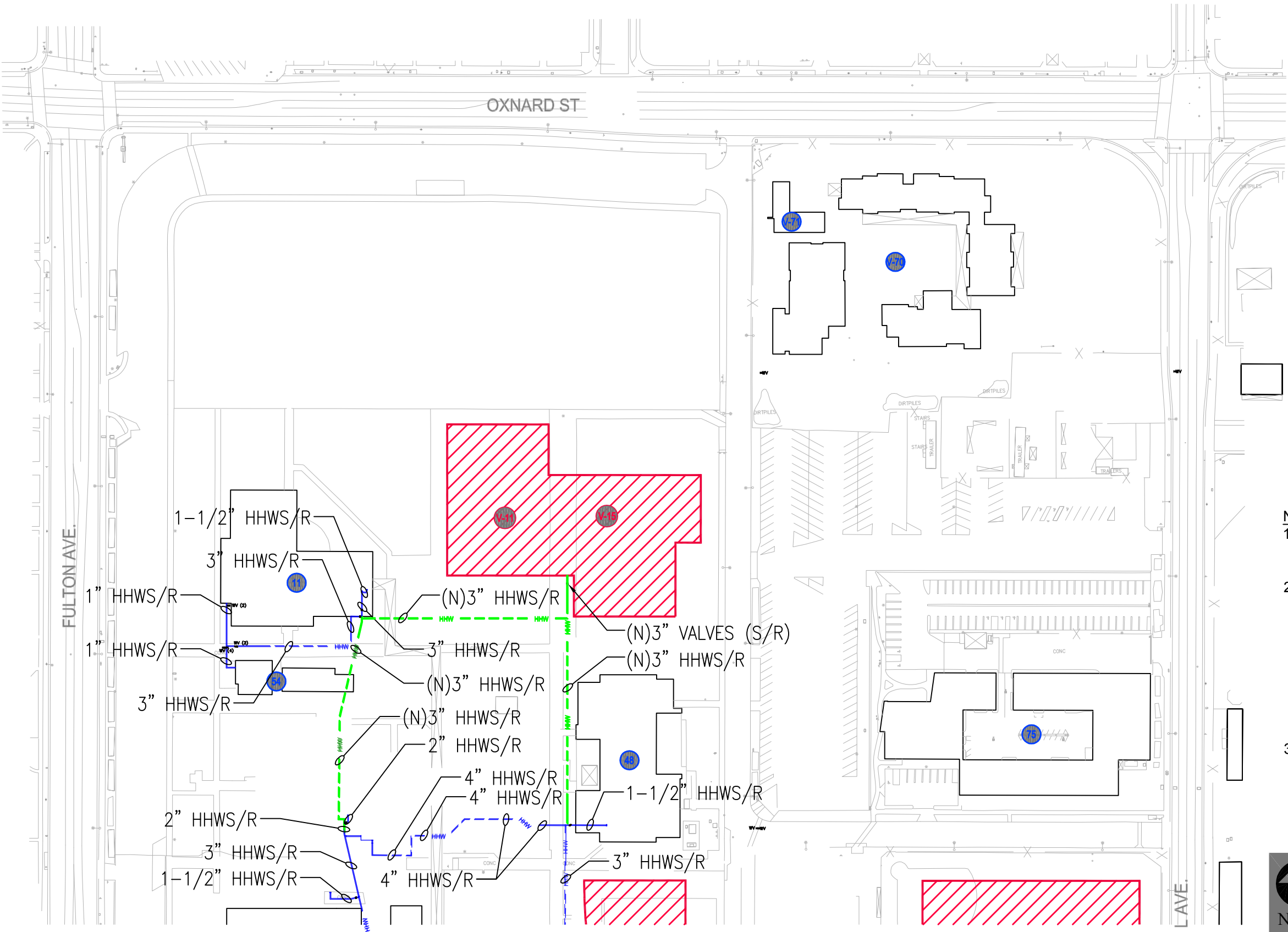






**NOTE:**  
 1. REFER TO TABLES ES-1 AND ES-2 FOR BUILDING NAMES.  
 2. THE INFORMATION SHOWN HEREON IS A GRAPHICAL DEPICTION OF THE EXISTING CAMPUS UTILITY SYSTEMS. THE SITE SURVEY AND INFRASTRUCTURE STUDIES EXISTING UTILITY PLANS PREPARED UNDER SEPARATE COVER SHALL BE REFERENCED FOR DETAILED INFORMATION

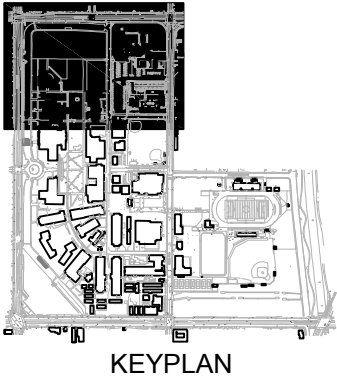


FIGURE 9c  
 EXISTING CONDITIONS UTILITY MAP - HOT WATER

*(Page Intentionally Left Blank)*



- LEGEND:**
-  EXISTING BUILDING
  -  PROPOSED MEASURE J BUILDING
  -  EXISTING HHW LINE
  -  PROPOSED HHW LINE



- NOTE:**
1. REFER TO TABLES ES-1 AND ES-2 FOR BUILDING NAMES.
  2. THE INFORMATION SHOWN HEREON IS A GRAPHICAL DEPICTION OF THE EXISTING CAMPUS UTILITY SYSTEMS. THE SITE SURVEY AND INFRASTRUCTURE STUDIES EXISTING UTILITY PLANS PREPARED UNDER SEPARATE COVER SHALL BE REFERENCED FOR DETAILED INFORMATION
  3. FUTURE CONDITIONS UTILITY MAPS SHOW ONLY THE DISPOSITION OF FUTURE BUILDINGS. REFER TO FIGURE 0e-MEASURE J MASTER PLAN SUMMARY FOR COMPLETE LAYOUT OF FUTURE CONDITIONS.



FIGURE 9e  
 FUTURE CONDITIONS UTILITY MAP - HOT WATER

*(Page Intentionally Left Blank)*

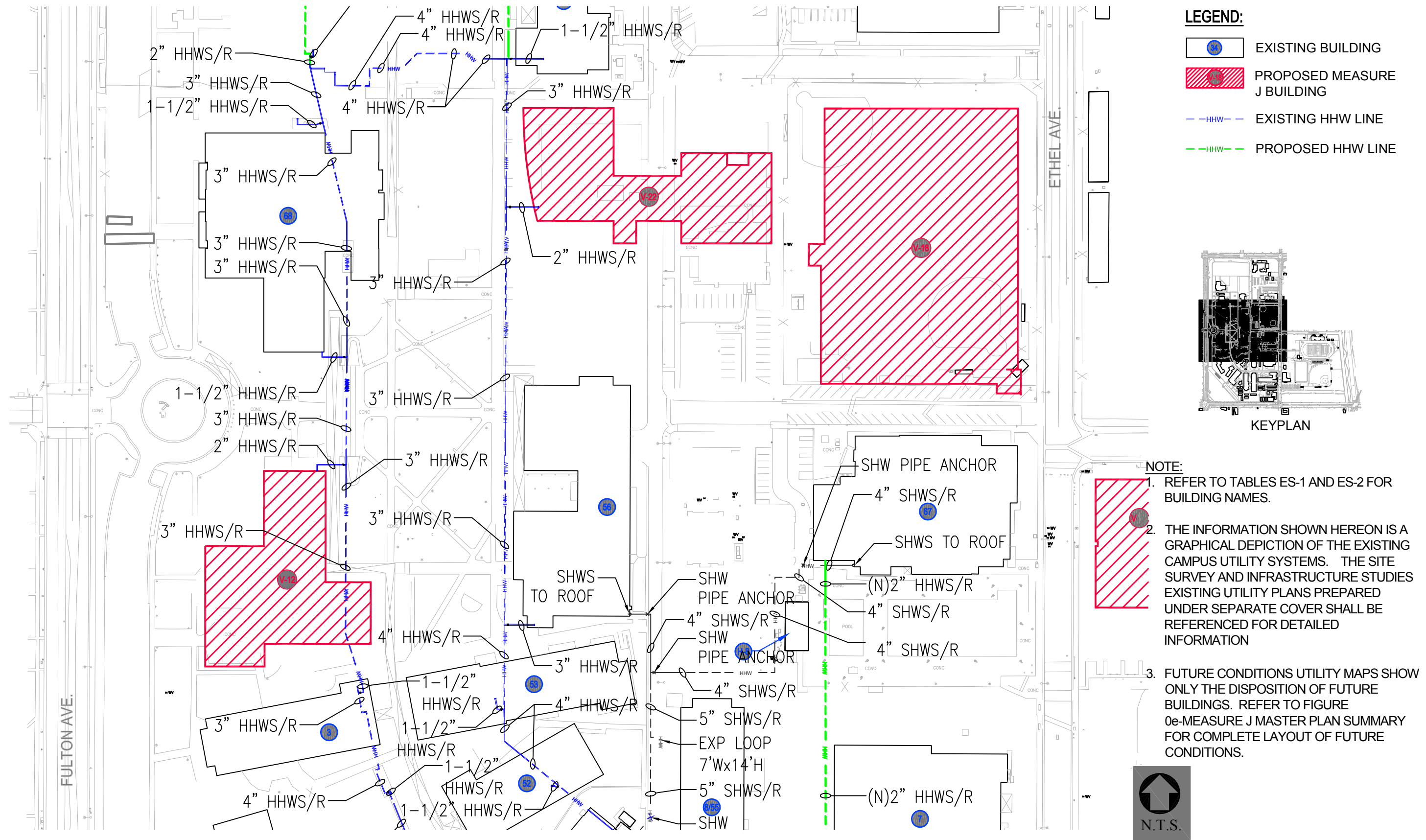
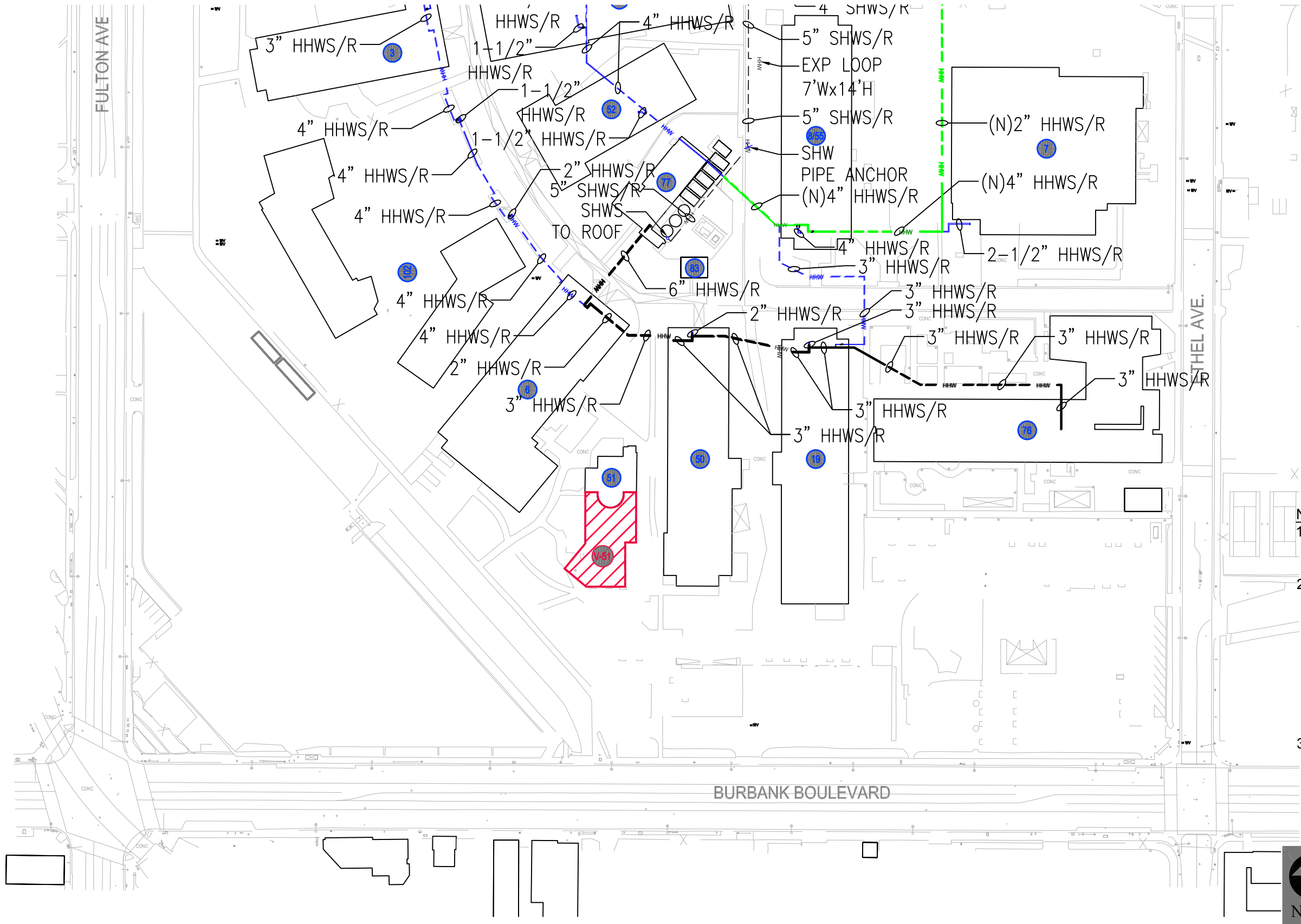
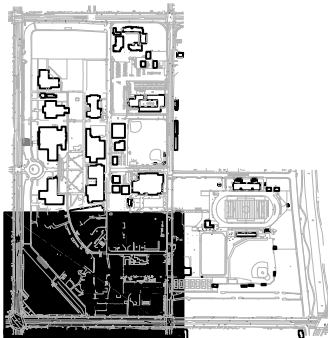


FIGURE 9f  
 FUTURE CONDITIONS UTILITY MAP - HOT WATER

*(Page Intentionally Left Blank)*



- LEGEND:**
- EXISTING BUILDING
  - PROPOSED MEASURE J BUILDING
  - EXISTING HHW LINE
  - PROPOSED HHW LINE

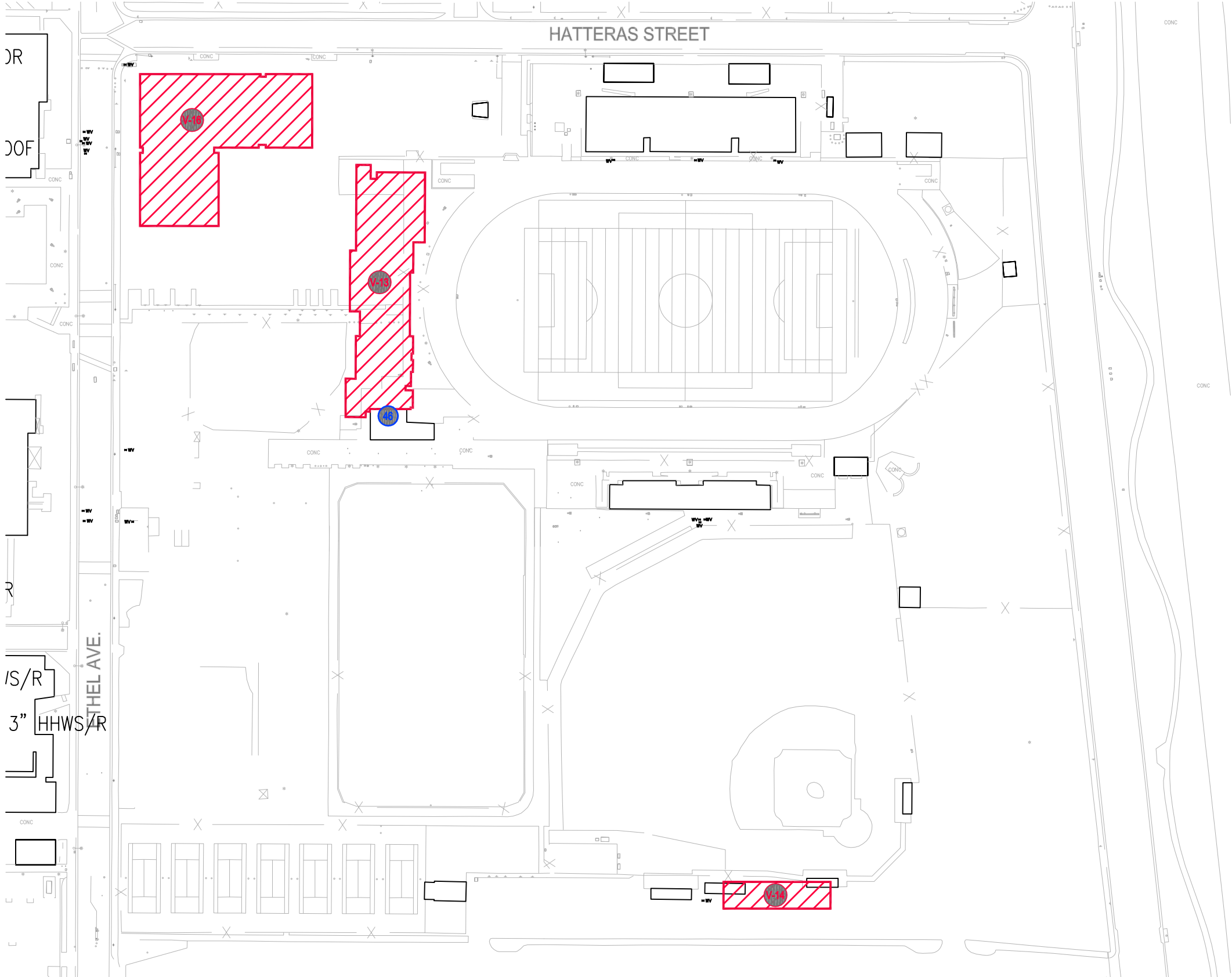






- NOTE:**
1. REFER TO TABLES ES-1 AND ES-2 FOR BUILDING NAMES.
  2. THE INFORMATION SHOWN HEREON IS A GRAPHICAL DEPICTION OF THE EXISTING CAMPUS UTILITY SYSTEMS. THE SITE SURVEY AND INFRASTRUCTURE STUDIES EXISTING UTILITY PLANS PREPARED UNDER SEPARATE COVER SHALL BE REFERENCED FOR DETAILED INFORMATION
  3. FUTURE CONDITIONS UTILITY MAPS SHOW ONLY THE DISPOSITION OF FUTURE BUILDINGS. REFER TO FIGURE 0e-MEASURE J MASTER PLAN SUMMARY FOR COMPLETE LAYOUT OF FUTURE CONDITIONS.

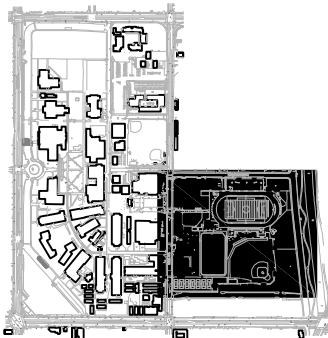


FIGURE 9g  
 FUTURE CONDITIONS UTILITY MAP - HOT WATER

*(Page Intentionally Left Blank)*



- LEGEND:**
-  EXISTING BUILDING
  -  PROPOSED MEASURE J BUILDING
  -  EXISTING HHW LINE
  -  PROPOSED HHW LINE



KEYPLAN

- NOTE:**
1. REFER TO TABLES ES-1 AND ES-2 FOR BUILDING NAMES.
  2. THE INFORMATION SHOWN HEREON IS A GRAPHICAL DEPICTION OF THE EXISTING CAMPUS UTILITY SYSTEMS. THE SITE SURVEY AND INFRASTRUCTURE STUDIES EXISTING UTILITY PLANS PREPARED UNDER SEPARATE COVER SHALL BE REFERENCED FOR DETAILED INFORMATION
  3. FUTURE CONDITIONS UTILITY MAPS SHOW ONLY THE DISPOSITION OF FUTURE BUILDINGS. REFER TO FIGURE 0e-MEASURE J MASTER PLAN SUMMARY FOR COMPLETE LAYOUT OF FUTURE CONDITIONS.



FIGURE 9h  
 FUTURE CONDITIONS UTILITY MAP - HOT WATER

*(Page Intentionally Left Blank)*

**SECTION 10 – CENTRAL PLANT SYSTEM**

10.1 SYSTEM DESCRIPTION

The LA Valley College Chilled Water Central Plant System consists of a combination of electric chillers, absorption chiller and ice thermal energy storage system. The Central Plant is located on south end of campus drive adjacent to the Life Science building. The original central plant equipment was installed in 2001. It consists of a hot water absorption chiller in series with an electric chiller, ice builder and thermal energy storage (TES) system. The plant chilled water distribution pumping configuration is Variable Primary Loop (VPL) distribution system. Two (2) single double cell cooling towers provide heat rejection via condenser water pumps to chillers. Equipment capacities and operating parameters are in Tables 10-1 through 10-5.

Table 10-1: Chilled Water System

Chiller Tag	Equipment Type	Nominal Tons	Evaporator GPM	Entering CHWR, °F	Leaving CHWS, °F	CHW ΔT, °F	COP or kW/ton
CH-1	Electric	900	2,160	54	44	10	0.533
CH-2	Electric	400	1,500	31.7	25	6.7	0.753
CH-3	Absorption, Double Effect, Single Stage	350	1,200	56.2	49.3	6.9	0.0197

Table 10-2: Chilled Water Pumping System

Pump Tag	Equipment Type	GPM	Head, FT	Hp	Variable Frequency Drive
CHWP-3	Centrifugal, End Suction	1,000	140	50	Yes
CHWP-4	Centrifugal, End Suction	1,000	140	50	Yes
CHWP-5	Centrifugal, End Suction	1,950	140	125	Yes

Table 10-3: Chilled Water Condenser Water System

Chiller Tag	Equipment Type	Nominal Tons	Condenser GPM	Entering CWS, °F	Leaving CWR, °F	CW ΔT, °F
CH-1	Electric	900	2,160	54	44	10
CH-2	Electric	400	1,500	31.7	25	6.7
CH-3	Absorption, Double Effect, Single Stage	350	1,200	56.2	49.3	6.9

Table 10-4: Chilled Water Cooling Tower

Cooling Tower Tag	Equipment Type	Cooling Capacity (MBH/Ton)	GPM	Entering CWR, °F	Leaving CWS, °F	Design Wet Bulb, °F	Fan Hp	Fan VFD
CT-1	Two Cell, Counterflow, Induced Draft	9,000/750	2,250	92	82	74	2 at 15	Yes
CT-2	Two Cell, Counterflow, Induced Draft	13,550/1,129	2,710	92	82	74	2 at 25	Yes

In 2009 as part of the Central Plant Upgrade Project installation, a new single stage, double effect hot water absorption chiller (CH-3) was provided. This Chiller (CH-3) operates when the TES Heat Exchanger and CH-1 are online to provide a measure of pre-cooling to the chilled water system. The chiller side streams return water from the chilled water return main, cools the water, and reintroduces it into the suction header at the primary chilled water pumps. This system consists of the chiller, chilled water pump, cooling tower and condenser pump. Equipment capacities and operating parameters are shown in Tables 10-6 through 10-9.

Table 10-5: Condenser Water Pumping System

Pump Tag	Equipment Type	GPM	Head, FT	Hp	Variable Frequency Drive
CWP-1 & 2	Centrifugal, End Suction	1,125	50	25	No
CWP-3	Centrifugal, Vert. Inline	2,710	50	50	No

Table 10-6: Absorption Chiller System

Chiller Tag	Equipment Type	Nominal Tons	Evaporator GPM	Entering CHWR, °F	Leaving CHWS, °F	CHW ΔT, °F	COP or kW/ton
CH-3	Absorption, Double Effect, Single Stage	350	1,200	56.2	49.3	6.9	0.0197

Table 10-7: Absorption Chiller Pumping System

Pump Tag	Equipment Type	GPM	Head, FT	Hp	Variable Frequency Drive
CHWP-5	Centrifugal, End Suction	1,950	140	125	Yes

Table 10-8: Absorption Chiller Condenser Water System

Pump Tag	Equipment Type	GPM	Head, FT	Hp	Variable Frequency Drive
CWP-3	Centrifugal, End Suction	2,710	50	50	No

Table 10-9: Absorption Chiller Cooling Tower

Cooling Tower Tag	Equipment Type	GPM	Entering CWR, °F	Leaving CWS, °F	Design Wet Bulb, °F	Fan Hp	Fan VFD
CT-2	Counterflow, Induced Draft	2,710	92	82	74	(2)25	Yes

Table 10-10: Glycol Chiller System

Chiller Tag	Equipment Type	Nominal Tons	Evaporator GPM	Entering CHWR, °F	Leaving CHWS, °F	CHW ΔT, °F	kW/ton
CH-2 (ice mode)	Electric, Centrifugal	400	1500	28	22	6	0.753

The Central Plant Upgrade Project has provided two (2) additional ice thermal storage tanks, glycol injector and secondary pumping capabilities. Two enhanced secondary pumps will circulate the glycol through an array of thermal energy storage tanks to make ice. In discharge mode these same pumps circulate the glycol through plate and frame heat exchanger to produce chilled water for distribution to the campus. A primary chilled water pump will circulate return water from the campus through the heat exchanger to distribute chilled water to the campus. This new primary pump is connected to the campus chilled water supply and returns mains in the original central plant and is in parallel to the existing primary pumps in the original central plant installation. A new single two (2) cell cooling tower and condenser water pump on a common header provide heat rejection for the chillers in the expansion. Equipment capacities and operating parameters are in Tables 10-10 through 10-15.

Heating Hot Water System

The LA Valley College Heating Hot Water (HHW) Central Plant System provides low temperature hot water for space heating and domestic hot water use for majority of the campus buildings. The Central Plant is located on south end of campus drive adjacent to the Life Science building. The original central plant equipment was installed in 2001. It consists of seven (7) modular type hot water generation boilers with associated two (2) primary distribution pumps, one (1) absorber hot water generator with associated two (2) absorber hot water pumps, and three (3) solar hot water storage tanks with associated two (2) circulation pumps. The plant heating hot water distribution pumping configuration is Variable Primary Loop (VPL) distribution system. Equipment capacities and operating parameters are shown in Tables 10-16 through 10-21.

Table 10-11: Glycol Chiller Pumping System

Pump Tag	Equipment Type	GPM	Head, FT	Hp	Variable Frequency Drive
CHWP-1	Centrifugal, End Suction	1,200	75	40	Yes
CHWP-2	Centrifugal, End Suction	1,200	75	40	Yes

Table 10-12: Glycol Chiller TES System

TES Ice Bank Tag	Equipment Type	Capacity, ton-hrs	Glycol Flow, GPM	Glycol Entering Temp, °F	Glycol Leaving Temp, °F
IT-1 thru IT-4		761	300	22	28
IT-5 thru IT-6		761	400	22	28

Table 10-13: Glycol Chiller Heat Exchanger

Heat Exchanger Tag	Equipment Type	Glycol Flow, GPM	Glycol Entering Temp, °F	Glycol Leaving Temp, °F
HX-1	Plate and Frame	1,913	41	51.4

Table 10-14: Glycol Chiller Condenser Water Pumping System

Pump Tag	Equipment Type	GPM	Head, FT	Hp	Variable Frequency Drive
CWP-3	Centrifugal, End Suction	2,710	50	50	No

Table 10-15: Glycol Chiller Cooling Tower

Cooling Tower Tag	Equipment Type	GPM	Entering CWR, °F	Leaving CWS, °F	Design Wet Bulb, °F	Fan Hp	Fan VFD
CT-2	Counterflow, Induced Draft	2,710	92	82	74	(2)25	Yes

10.2 ESTIMATED LOADS AND CAPACITIES

The Central Plant Chilled Water System currently serves the majority of buildings cooling on campus. The current total cooling system production nominal capacity is 1,650 tons without counting the Glycol TES Tanks (6) during on-peak chilled water supply mode of operation. A breakdown of the current Chilled Water System Production Capacity is shown in Table 10-22.

Data corresponding to the following campus load analysis is summarized in the Chilled Water System Tables 10-25 and 10-26 at the end of this section. A complete detailed discussion of the data in these Tables can be found in Section 8, Chilled Water System.

The current situation, the beginning of 2010, diversified connected campus load including the recently completed Allied Health Science and South Gym buildings is 1,160 tons. This current load will be satisfied fully without a significant concern with respect to the equipment failure due to the current arrangement of N+1 redundancy in the system. The estimated cooling loads at the end of year 2011, 2012, 2013, and 2014 will be respectively 1,340, 1,415, 1,899, and 1,899 tons. The current situation will be good till end of the year 2012, and then the current cooling system will be maxed out as shown in the Section 8 Load Table.

By end of the year 2014, many new buildings will be added and online: Library & Academic Resource Center, Media Art Center, Performance Arts Center, Student Services and Student Union Buildings. In addition, the Administration and Planetarium Buildings will be renovated and expanded. LAVC Facility Department has requested to include the existing North Gym and three (3) new Athletic Center Buildings coming online to be potentially connected to Central Plant. These expansion installations will add an additional 739 tons to the existing diversified connected campus load bringing the total load up to 1,899 tons for the Scenario I. If the standalone satellite central plant is available for the three new Athletic Center Buildings and North Gym, then 1,728 ton is required for the Scenario II that is still exceeding the Central Plant Cooling Load Production Capacity (Nominal 1,650 tons). Therefore, for the year 2013 and thereafter, the failure(s) of any chiller between CH-1 thru CH-3, and/or the main primary pump CHWP-5 will result in the shortage of cooling capacity and not being able to satisfy adequately. This is due to the slight shortage of cooling production capacity (1,650 tons nominal production capacity vs. 1,899 ton peak connected load demand), and no available spare capacity and N+1 redundancy in the system for the new expanded campus loads. Therefore, the sufficient spare capacity (20% plus) and system redundancy is required for the new expanded campus load to be in consistent with the California Higher Education Industry Best Practices. A new 600 ton capacity chiller plant will be required to satisfy the above mentioned requirements and also possible needs of the future expansion.

The most probable failure(s) related to the CHW System would be loss of the Glycol Chiller (CH-2) and the main Chiller (CH-1), and/or main

Table 10-16: Heating Hot Water System

Boiler Tag	Equipment Type	Nominal MBH	FLOW GPM	Entering HHWR, °F	Leaving HHWS, °F	HHW ΔT, °F	Thermal Efficiency (%)
B-1	Gas	1,760	88	140	180	40	88
B-2	Gas	1,760	88	140	180	40	88
B-3	Gas	1,760	88	140	180	40	88
B-4	Gas	1,760	88	140	180	40	88
B-5	Gas	1,760	88	140	180	40	88
B-6	Gas	4,400	220	140	180	40	88
B-7	Gas	4,400	220	140	180	40	88

Table 10-17: Heating Hot Water Pumping System

Pump Tag	Equipment Type	GPM	Head, FT	Hp	Variable Frequency Drive
HP-1	Centrifugal, End Suction	542	110	25	Yes
HP-2	Centrifugal, End Suction	542	110	25	Yes

Table 10-18: Absorber Hot Water Generator System

Equipment Tag	Equipment Type	Nominal MBH	Hot Water GPM	Entering HWS, °F	Leaving HWR, °F	Hot Water ΔT, °F
CH-3	Absorption, Double Effect, Single Stage	6,095	530	190	167	23

Table 10-19: Absorber Hot Water Generator Pumping System

Pump Tag	Equipment Type	GPM	Head, FT	Hp	Variable Frequency Drive
HWP-10	Centrifugal, End Suction	265	50	5	Yes
HWP-11	Centrifugal, End Suction	265	50	5	Yes

Distribution Pump (CHWP-5) that will negatively impact the availability of campus CHW system significantly and also unsatisfactory for operation.

If any of above equipment failure(s) were happen, a new 240,000 gal. chilled water TES tank system, 600 ton capacity new chiller plant and a new 1,950 GPM backup primary pump with variable speed drive additions will be required to supplement the full N+1 redundancy and 20% spare capacity requirements. The new proposed central plant cooling production capacity with these additions is shown in Table 10-23.

With the new additions of a Chilled Water TES tank system, 600 ton capacity new chiller plant and a spare primary pump, a loss of the 900 ton main chiller and/or 400 ton ice maker, and/or a 1,950 GPM capacity primary distribution pump with VSD will result in the campus new load requirements being satisfied for the year 2014 upcoming new campus expansion configuration and not only provide a significant operational flexibility with N+1 redundancy, but also “On-Peak Demand Limiting” energy cost savings to the campus central plant operation. The existing Absorption Chiller (CH-3) is operating based on the solar heat gain and only available during the mid day time (11 AM to 6 PM). Based on the campus load profile, it is required to provide a substantial cooling and heating loads for early morning and evening classes. This special situation mandates to expand the operation hours of the Absorption Chiller from 7 AM to 11 AM for morning classes and from 6 PM to 10 PM for evening classes to achieve the claimed full production capacities of both cooling (350 tons) and heating (6,095 MBHs). Therefore, a new high temperature boiler and storage tank are required to provide the additional heat energy required for the extended chiller production hours.

The Central Plant Heating Hot Water System currently serves the majority of buildings heating on campus. The total system production capacity is 23,695 MBHs without utilizing the Solar Hot Water TES tanks. A breakdown of the Heating Hot Water System Capacity is shown in Table 10-24.

Data corresponding to the following campus load analysis is summarized in the Heating Hot Water System at the end of this section. A complete detailed discussion of the data can be found in Section 9, Heating Hot Water System.

The current situation, the beginning of 2010, diversified connected campus load including the recently completed Allied Health Science and South Gym buildings is 13,476 MBHs. This current load will be satisfied fully without a significant concern with respect to the boiler equipment failure due to the current arrangement of N+1 redundancy in the system. However, there is no sufficient arrangement of N+1 redundancy for the main distribution pump system during the current on-peak load mode of operation. The estimated heating loads at the end of the year 2011, 2012, 2013, and 2014 will be 14,887, 15,417, 20,784, and 20,784 MBHs respectively as shown in the Section 9 Heating Load Table.

By the end of 2014, many new buildings will be added and online: Library & Academic Resource Center, Media Art Center, Performance Arts Center, Student Services and Student Union Buildings. In addition, the

Table 10-20: Solar Hot Water Storage Tank System

Tank Tag	Equipment Type	Capacity Gal	Size D X H Ft.	Rated Press Psig	Oper. Wt. Lbs.	Service Utility
HWST-1	Steel Tank, Yard	24,000	14 X 22.75	50	254,000	Solar Hot Water
HWST-2	Steel Tank, Yard	24,000	14 X 22.75	50	254,000	Solar Hot Water
HWST-3	Steel Tank, Yard	24,000	14 X 22.75	50	254,000	Solar Hot Water

Table 10-21: Solar Hot Water Storage Tank Pumping System

Pump Tag	Equipment Type	GPM	Head, FT	Hp	Variable Frequency Drive
SHWP-1	Centrifugal, End Suction	332	90	10	No
SHWP-2	Centrifugal, End Suction	332	90	10	No

Table 10-22: Chilled Water System Capacity

Equipment	Location	Tons	Remarks
CH-1	Main Plant (CHWS/R)	900	In series w/CH-3
CH-2	Main Plant (ICE)	400	In series w/CH-1
CH-3	Main Plant (CHWS/R)	350	In series w/CH-1
TES (ice bank)	Main Plant (CHWS/R)	[840]	Average based on 4,200 ton-hr during 5 hour on-peak window, TES discharge In series w/CH-1 & CH-3
<b>Total</b>		<b>1,650</b>	

Administration and Planetarium Buildings will be renovated and expanded. LAVC Facility Department has requested to include the existing North Gym and three (3) new Athletic Center Buildings coming online to be potentially connected to the Central Plant. These expansion installations will add an additional 7,308 MBHs to the diversified connected campus load that is bringing the total load up to 20,784 MBHs for the Scenario I. If the standalone satellite central plant were available for the three new Athletic Center Buildings and North Gym, then 18,883 MBHs is required for the Scenario II. Therefore, for the year 2010 and thereafter, the failure of any distribution pumps between HP-1 and HP-2 will result in the shortage of heating capacity and campus load not being adequately satisfied. This is due to no sufficient arrangement of N+1 redundancy in the system for the current as well as the new expanded campus loads. Therefore, the sufficient arrangement of redundancy is required for the current and new campus load capacities to be in consistent with the California Higher Education Industry Best Practices.

10.3 FINDINGS AND RECOMMENDATIONS

By the year 2014, additional cooling equipment and spare capacity will be required to meet the diversified connected campus load of 1,899 tons. Providing the sufficient N+1 redundancy capability is required in the event that the main piece of chillers (900 ton & 400 ton ice-maker) and/or the chilled water distribution pump (1,950 GPM) and heating hot water distribution pump (542 GPM) with variable speed drive equipments are failed and non-operational. There is some limitation to increasing the load capacity at this location due to the space constraints of the existing central plant, however, it is recommended to perform the detailed feasibility study to fit out the new equipments with options. After review of the several viable options (additions of thermal storage capacity, high-temperature heating boiler and storage tank, and new chiller plant), the following recommendations have been made for this master planning study for the central plant operation.

The recommendations have been categorized into three priority levels. Descriptions of each priority level are provided in the executive summary of this report.

Priority 1

- Thermal Energy Storage (TES) Tank for Chilled Water System by the year 2013 at the completion of the Phase 2 Construction
- New Chiller Plant that consists of 600 Ton Cooling Capacity, High-Efficiency Centrifugal Chiller and its associated ancillary systems including cooling tower cell, pumps, controls, and piping header ties for future expansion by the year 2013 at the completion of the Phase 2 Construction
- Spare Chilled Water Distribution Pump with VSD by the year 2011 at the Pre-Phase 1 Construction
- Spare Heating Hot Water Distribution Pump with VSD by the year 2011 at the Pre-Phase 1 Construction

- New High-temperature Hot Water Boiler and Storage Tank, and its associated piping and controls by the year 2011 at the Pre- Phase 1 Construction

Table 10-23: New Proposed Central Plant Cooling Production Capacity

Equipment	Location	Tons	Remarks
CH-1	Main Plant (CHWS/R)	900	In series w/CH-3
CH-2	Main Plant (ICE)	400	In series w/CH-1
CH-3	Main Plant (CHWS/R)	350	In series w/CH-1
CH-4	Main or Satellite Plant (CHWS/R)	600	In series w/CH-3
TES (ice bank)	Main Plant (CHWS/R)	[840]	Average based on 4,200 ton-hr during 5 hour on-peak window, TES discharge In series w/ CH-1 & CH-3
TES (Chilled Water)	Main Plant (CHWS/R)	[900]	Average based on 3,600 ton-hr during 4 hour on-peak window, TES discharge In series w/ CH-3
<b>Total</b>		<b>2,250</b>	

Table 10-24: Heating Hot Water System Capacity

Equipment	Location	MBHs	Remarks
B-1	Main Plant (HHWS/R)	1,760	In series w/B-2 thru B-7
B-2	Main Plant (HHWS/R)	1,760	In series w/B-1 thru B-7
B-3	Main Plant (HHWS/R)	1,760	In series w/B-1 thru B-7
B-4	Main Plant (HHWS/R)	1,760	In series w/B-1 thru B-7
B-5	Main Plant (HHWS/R)	1,760	In series w/B-1 thru B-7
B-6	Main Plant (HHWS/R)	4,400	In series w/B-1 thru B-7
B-7	Main Plant (HHWS/R)	4,400	In series w/B-1 thru B-6
CH-3	Main Plant (HHWS/R)	6,095	In series w/B-1 thru B-7
<b>Total</b>		<b>23,695</b>	

Priority 2

In the year 2014, the existing 900 ton and 400 ton ice-maker chillers and distribution pumps with variable speed drives will be approaching 13 years services with an exception to a newer chiller pump such that they might face a significant risk of failure mode due to its equipment aging.

Therefore, it is imperative to provide a chilled water thermal energy storage (TES) system, 600 ton new chiller and spare distribution pumps with variable speed drives for the system N+1 redundancy capability and also “On-Peak” Demand Limiting to the central plant for annual operating energy cost savings and also qualify for the local utility (LADWP) Energy Incentive Rebate Program. This electric Incentive rebate program will be addressed in the Section 5 electrical system for further details.

The first three recommendations will provide the adequate cooling requirements for 1,899 tons of connected loads and 20% spare capacity that will support the year 2014 projected campus connected load plus target spare capacity, and also the system N+1 redundancy capability when the failure(s) of the main 900 ton or 400 ton chillers (CH-1 & CH-2), and/or the main distribution pump (CHWP-5) with variable speed drive happen.

New chilled water Thermal Energy Storage (TES) tank, chiller plant, and boiler and storage tank need to fit out to Central Plant and/or the new Parking Structure. It is recommended to have a detailed feasibility study for development of fit-out options, design & construction schedules and its implementation plans. In order to meet the schedule requirements of the above recommendations, the new Parking Structure may need to be expedited as the Phase 2 Construction instead of the Phase 3.

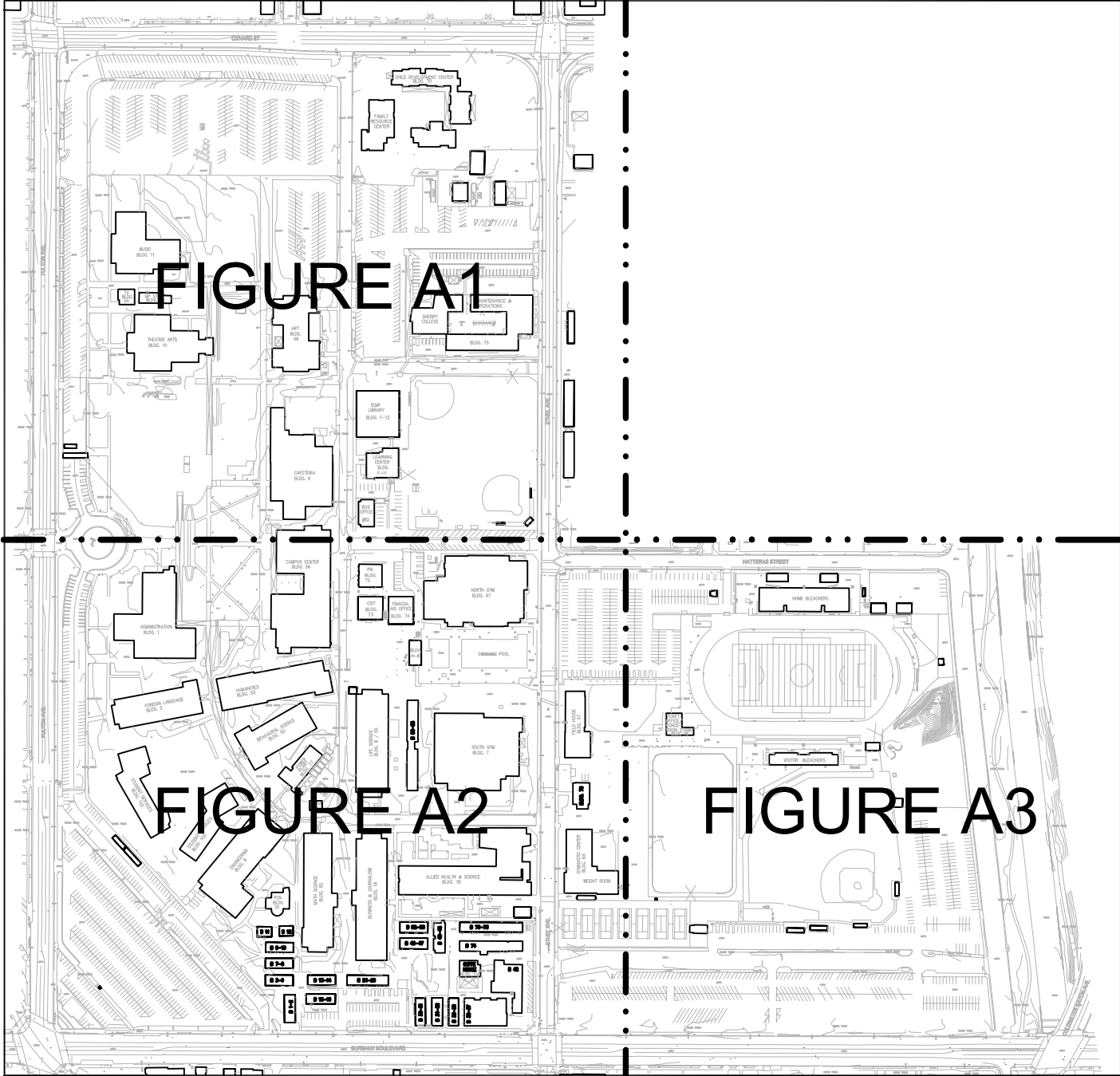
Additionally, the last recommendation will provide the sufficient heating load requirements to meet the projected campus connected load and also the system N+1 redundancy capability.

*(Page Intentionally Left Blank)*

## **APPENDIX A**

### **Existing Utility Composite Map**

*(Page Intentionally Left Blank)*



**NOTE:**  
1. REFER TO ENCLOSED 24"x36"  
FIGURES A1, A2, AND A3



APPENDIX A  
EXISTING UTILITY COMPOSITE MAP - KEY MAP

*(Page Intentionally Left Blank)*

## **APPENDIX B**

### **Los Angeles Valley College Utility Master Plan Data Collection Log**

*(Page Intentionally Left Blank)*

**LAVC Utility Master Plan - Data Collection Log**

No.	Description	Date Received	Project Status	Prepared By	Document Date	Document Description	Type of Copy
<b>MASTER PLAN DOCUMENTS</b>							
1	Master Plan - Site Plan	9/15/09	draft	Steinberg Architects	9/10/09	draft	AutoCAD
2	Master Plan - Site Utility Plan	9/15/09	-	Steinberg Architects	-	-	AutoCAD
3	Campus Building Inventory	9/15/09	complete	Steinberg Architects	6/3/09	complete	PDF
4	Master Plan Cost Summary	9/15/09	draft	Steinberg Architects / Cumming	8/21/09	draft	PDF
5	Prop J master Plan Workshop 6	9/15/09	complete	Steinberg Architects	8/25/09	complete	PDF
6	Prop J Master Plan Workshop 7	9/15/09	complete	Steinberg Architects	9/10/09	complete	PDF
7	Master Plan Horizon 1 diagram	9/15/09	draft	Steinberg Architects	9/10/09	draft	PDF
8	Master Plan Horizon 2 diagram	9/15/09	draft	Steinberg Architects	9/10/09	draft	PDF
9	Master Plan Landscape diagram	9/15/09	draft	Steinberg Architects	9/10/09	draft	PDF
10	Building Utilization Summary	9/15/09	draft	Steinberg Architects	9/15/09	draft	PDF
11	Aerial Photo	9/17/09	-	-	-	-	
12	LACCD Sustainability Standards	9/17/09	complete	Glumac	March. 2009	-	PDF
13	Final EIR	9/17/09	complete	Myra L. Frank & Assoc.	Aug. 2003	-	PDF
14	EIR Addendum	9/17/09	complete	Myra L. Frank & Assoc.	12/20/06	-	PDF
15	LAVC Draft Master Plan - Infrastructure Committee Master Plan Overview	3/25/10	-	Steinberg Architects	1/27/10	Presentation Materials	PDF
16	LAVC Draft Master Plan - Presentation Boards	3/25/10	-	Steinberg Architects	1/27/10	Presentation Materials	PDF
17	LAVC Draft Master Plan - Horizon 1	3/25/10	-	Steinberg Architects	1/27/10	Base File	CAD
18	LAVC Draft Master Plan - Horizon 2	3/25/10	-	Steinberg Architects	1/27/10	Base File	CAD
<b>CAMPUS DOCUMENTS</b>							
19	Gym Complex Renovation Phase 2	9/17/2009 and 11/06/09	project stopped	Langdon Wilson Architects	12/22/04	100% CD	AutoCAD
20	Allied Health Building	9/17/09	Construction Complete - No Redlines	CO Architects	-	bid set -Architectural Sheets	AutoCAD

## LAVC Utility Master Plan - Data Collection Log

No.	Description	Date Received	Project Status	Prepared By	Document Date	Document Description	Type of Copy
21	Athletic Fields - Field House and Concession Building	9/17/09	in design	Cannon Design	5/31/05	schematic design	PDF and CAD
22	Humanities Modernization - Selective Structure Demolition	9/17/09	Construction Complete	Caldwell Architects	2/26/07	-	AutoCAD
23	Library Academic Resource Center	9/17/09	Under Construction	Pfeiffer Architects	3/9/09	bid set	AutoCAD
24	New M&O Building and Sheriff Station	9/17/09	Construction Complete	La Canada Design Group	2/1/07	record set	AutoCAD
25	Temp Library and GI / SI / IMS Modular Buildings	9/17/09	Construction Complete	LHA (GKKworks)	4/17/08	DSA approved set	PDF and CAD
26	PV Package 4	9/25/09	DSA approved	Chevron	6/12/08	DSA approved	CAD
27	Central Plant Package 2	9/25/09	DSA approved	Chevron	6/12/08	100% CD	CAD
28	PV Package 4	9/25/09	Construction Complete	Chevron	1/3/09	Asbuilt Files	CAD
29	Utilities Infrastructure and LADWP Substation Upgrade	9/25/09	DSA approved	Chevron	5/18/09	DSA approved	PDF and CAD
30	Student Services Center	10/22/09	Under Construction	Steinberg	8/14/08	DSA approved	PDF and CAD
31	Allied Health & SCI_Elec Cad Files 9-06	10/14/09	Construction Complete	CO Architects - formerly Anshen+Allen-LA	9/19/2006	Electrical Drawings Bid Set	CAD
32	CTS VALLEY_Enginnering Report 11-19-07	10/14/09	-	CTG Engineering, Inc.	11/19/2007	VE Reports: Library and LRC, Gymnasium, Media Arts, Library and Academic Center, Child Development Center	PDF
33	Child Development Center	10/14/09	Under Construction	Cade Ten Architects	7/25/2008	Addendum 1, Addendum 2, Bid Tabulation, Campus Map, Notice To bidders, Plans, Pre Bid Sign in Sheet, Specifications.	PDF
34	M&O Sheriff Station Record Dwgs	10/14/09	Construction Complete	La Canada Design Group	3/27/2007	M&O Sheriff Station Record Dwgs	CAD/PDF
35	ChevronTexaco LAVC Topo Survey & UT Mapping	10/14/09	Construction Complete	JT Engineering, Inc.	2/2/2004	Topo Survey, Utility Mapping	CAD
36	LAVC_08v-8.2-6809_Student Services Center 100%_CD	10/14/09	Under Construction	Steinberg Architects	7/16/2007	100%CD_Architectura, Av com, Civil, Electrical, Landscape, Mechanical, Plumbing, Structural	CAD/PDF
37	LAVC_08v-8.3-6817_Foreing Language	10/14/09	Construction Complete	LHA Leiden frost / Horowitz & Assoc.	2/22/2005	Architectural Building 3 Drawings, For Land Drawing Log Excel sheet	CAD/XLS
38	LAVC_08V.6803.004.09_AHSC_Allied Health Science Center	10/14/09	Construction Complete	CO Architects - formerly Anshen+Allen-LA	6/21/2006	Bid Set Mechanical & Plumbing	CAD
39	LAVC_18V.7879.03.02_Chevron E.S. Central Plant Utilities Fire Water	10/14/09	Construction Complete	Chevron E.S.	9/22/2009	Utilities Fire Water	PDF
40	LAVC_18V.7879.03.03_Campus Improvements IT Core Record Dwgs and Specs	10/14/09	Construction Complete	Steinberg Architects	6/19/2009	Record Drawings, Specification Record Set	CAD/PDF/DOC
41	Allied ESMC Asbuilts	10/14/09	Construction Complete	CO Architects - formerly Anshen+Allen-LA	10/13/2008	Mechanical As Built	CAD
42	Allied Health & Science As-Built CSI Electrical Contractors	10/14/09	Construction Complete	CO Architects - formerly Anshen+Allen-LA	2/23/2003	Telecommunications As Built	PDF

## LAVC Utility Master Plan - Data Collection Log

No.	Description	Date Received	Project Status	Prepared By	Document Date	Document Description	Type of Copy
43	Allied Health And Science Building As built Record Documents Audio Visual Dwgs	10/14/09	Construction Complete	Audio Associates	1/26/2009	As Built Record Documents	CAD
44	Athletic Field Concession Stand Phase 1B 100% Constructability Review Back check	10/14/09	Construction Complete	Kchelle	3/4/2006	LAVC Concession Stand 100%CD Back check, Master Submittal Comments AE Report Excel sheet.	PDF/XLS
45	LAVC_Building 2,3,4,5,6_PDF Structural As-Builts	10/14/09	Construction Complete	STEINBERG ARCHITECTS (H.C. Chambers and Lester Hibbard Architects)	2/21/2008	As Built Drawings Original Prepared on the latest 50's	PDF
46	Campus Electrical As Builts	10/14/09	Construction Complete	(H.C. Chambers and Lester Hibbard Architects)	6/26/2008	As Built Drawings Original Prepared on the latest 50's	PDF
47	LAVC_CDC_08V.6831.02_Child Development Center_A-111066 DSA Approved Plans	10/14/09	Under Construction	Carde Ten Architects	2/19/2008	Specifications, Structural Test And Inspection, Approved Plans	PDF/TIFF
48	Library As-Builts 1950's	10/14/09	Construction Complete	(H.C. Chambers and Lester Hibbard Architects)	6/15/2009	Library As-Builts 1950's	PDF
49	Mapping CD	10/14/09	-	Psomas	7/8/2005	Final Survey,tunnel,Gas Line	CAD/PDF
50	As-Built Drawings AutoCAD & Vision Format Johnson Controls	10/14/09	Construction Complete	Johnson Control System	10/16/2008	As Built Drawings	CAD/VSD
51	Temporary Library 08v-8.4-6877.09 Bid Documents	10/14/09	Construction Complete	LACCD	4/30/2007	Bid Documents	PDF/XLS/DOC
52	Top Survey and Utilities Mapping	10/14/09	-	-	6/7/2006	Accessories, Administrative tools, Citrix,DMP, IrfanView,Startup,Internet Explorer, Remote Assistance, Widow Media Player	Various
53	Chevron Texaco Infrastructure Survey_Civil, Mechanical & Electrical	10/14/09	-	JT ENGINEERING, INC./CMS ENERGY VIRON ENERGY SERVICES	10/5/2005	Existing Gas, SD, Sewer, Water, Electrical, Telecommunications, Final Mechanical	CAD
54	Overall Survey With Tunnel	10/14/09	-	JT Engineering, Inc.	9/30/2004	Aerial Survey	CAD
55	Campus Wide UT As Built	10/14/09	Construction Complete	CMS Energy	1/4/2004	As Built	PDF
56	Irrigation Control Replacement	10/14/09	Construction Complete	P2S	11/19/2004	Bid Set Electrical Drawings	PDF
57	UT Tunnel_Files Record Dwgs 2	10/14/09	Construction Complete	H.C. Chambers and Lester Hibbard Architects	1950's To 1970's	Record Drawings/As Built Utility Tunnel, Electrical, Mechanical, Water, Gas.	PDF
58	UT Tunnel_Files Record Dwgs 1	10/14/09	Construction Complete	H.C. Chambers and Lester Hibbard Architects	1950's To 1970's	Record Drawings/As Built ,Electrical, Mechanical, Water, Gas.	PDF
59	Allied Health Building	11/6/09	Construction Complete - No Redlines	CO Architects	8/24/05	bid set and demolition plans	PDF
60	Field and Faciliities Concession Stand and RR	11/6/09	Construction Complete	Cannon Design	6/28/06	bidding documents (summary of work, budget, etc. not drawing)	Various
61	Ground Imporvements	11/10/09	Construction Complete	H.C. Chambers and Lester Hibbard Architects	12/16/59	campus record drawings	PDF
62	Landscape Sprinkler Plan	11/10/09	Construction Complete	H.C. Chambers and Lester Hibbard Architects	1950's To 1970's	asbuilt plans	PDF
63	MISCELLANEOUS CAMPUS AS BUILT DRAWINGS	11/10/09	Construction Complete	H.C. Chambers and Lester Hibbard Architects	6/18/64	asbuilt plans	PDF

## LAVC Utility Master Plan - Data Collection Log

No.	Description	Date Received	Project Status	Prepared By	Document Date	Document Description	Type of Copy
64	Campus Center Building	11/10/09	Construction Complete	H.C. Chambers and Lester Hibbard Architects	11/12/71	asbuilt plans	PDF
65	Field House - Track & Fields / Visitor Belachers, Relocated Restrooms and Scoreboard	11/10/09	Construction Complete	Cannon Design	4/4/06	bid set - DSA stamped/signed drawings	PDF
66	Art and Music Buildings Modernization Project (*no utilities)	9/17/09	Construction Complete	Gonzalez Goodale	4/15/08	pre-bid package	PDF and CAD
67	Fulton Entry (*no utilities)	9/17/09	Construction Complete	Berliner	8/20/08	Addendum	PDF and CAD
68	Modernization Projects - Business Journalism (*no utilities)	9/17/09	Construction Complete	Caldwell Architects	1/26/09	record set	PDF and CAD
69	Modernization Projects - Engineering Building (*no utilities)	9/17/09	Construction Complete	Caldwell Architects	2/27/08	DSA approved set	PDF
70	Modernization Projects - Life Science (*no utilities)	9/17/09	DSA approved set	Caldwell Architects	5/6/08	DSA approved set	PDF and CAD
71	Modernization Projects - Math and Science Building (*no utilities)	9/17/09	DSA approved set	Caldwell Architects	2/20/08	DSA approved set	PDF
72	Modernization Projects - Planetarium (*no utilities)	9/17/09	Construction Complete	Caldwell Architects	1/30/07	100% CD	AutoCAD
73	Behavior Sciences and Campus Center 2nd Floor (*no utilities)	9/17/09	100% CD	Leidenfrost/Horowitz & Assoc.	4/6/05	100% CD	AutoCAD
74	Site Accessibility / Path of Travel Reference Plans (*no utilities)	9/17/09	DSA approved set	Berliner	8/21/07	DSA approved set	PDF
75	Way Finding and Site Furniture - Phase 1 (*no utilities)	9/17/09	Construction Complete	Berliner	10/18/07	DSA approved set	PDF
76	Utilities Infrastructure and LADWP Substation Upgrade	2/4/10	Construction Complete	Chevron	11/9/09	As-Built Drawings of A, C, E, F, M Sheets	PDF and CAD
77	Utilities Infrastructure and LADWP Substation Upgrade	2/4/10	Construction Complete	Chevron	11/9/09	As-Built Drawings of P, S and T Sheets	AutoCAD
78	Media Arts / Performance Arts (MAPA) SD Drawings	3/19/10	In Design	Ehrlich Architects	12/23/09	Schematic Design Submittal	PDF
79	Temp Library Site Utility Plan	3/23/10	Construction Complete	Provided by CPM	-	record of utility installation	PDF
80	Fieldhouse Facilities - Concession Stand and Restrooms	4/14/10	Construction Complete	Provided by CPM	9/23/05	Bid Set	PDF
81	Fieldhouse - Track and Fields	4/14/10	Construction Complete	Provided by CPM	6/14/05	Bid Set	PDF
82	Athletic Training Facility	4/16/10	In Design	Cannon Design	3/30/10	Schematic Design Submittal: Specifications, BoD, Drawings	PDF
83	Temporary Library ASI-012	4/20/10	Complete	LHA	3/2/09	ASI Describing revision to IT cabling at the modular building project site.	PDF
84	Temporary Library Electrical Sketches SK-1, SK-2, and SK-3	4/20/10	Complete	LHA	9/25/08	Electrical sketches illustrating revisions to the Temporary Library electrical system	PDF

FROM E7

## LAVC Utility Master Plan - Data Collection Log

No.	Description	Date Received	Project Status	Prepared By	Document Date	Document Description	Type of Copy
85	LAVC_ACID Waste Replacement Piping System at Chemistry Building Number 5_Petra	10/14/09	-	Fields Devereaux Architects & Engineers	10/29/1999	Plumbing Chemistry Building Demolition Plan	PDF/TIFF
86	LAVC_Architectural Barrier Removal_98-1001	10/14/09	-	O'Leary Terasawa Partners AIA Architects	6/16/1995	Architectural Barrier Removal (signed drawings)	PDF/TIFF
87	LAVC_Architectural Barrier Removal_Michael_T	10/14/09	-	O'Leary Terasawa Partners AIA Architects	7/25/2008	Architectural Barrier Removal	TIFF
88	LAVC_Building 16 Math_Science Roof_Petra	10/14/09	-	-	Tiff Created 1/9/2007	Valley Bldg#16 Math/Science Roof	TIFF
89	LAVC_Building 18_Allesse	10/14/09	-	HCA Architecture Interiors	4/10/1980	Building 18 Reflected Ceiling Plan (Existing Plans)	TIFF
90	LAVC_Cafeteria Interior Renovation , Building No. 9_Flavio	10/14/09	-	KLGHolland,L.L.C.	12/20/1999	Cafeteria Renovation Demolition Plan	TIFF
91	LAVC_Campus Center Basement Ceiling Replacement	10/14/09	-	HCA Architecture Interiors	7/7/2003	Campus Center Basement Ceiling Replacement	CAD/XLS
92	LAVC_Campus Wide Utility Infrastructure As Built	10/14/09	-	JT ENGINEERING, INC./CMS ENERGY VIRON ENERGY SERVICES	7/11/2003	Existing Gas, SD, Sewer, Water, Electrical, Telecommunications, Final Mechanical	TIFF
93	LAVC_Ceiling Replacement and Upgrade	10/14/09	-	CMS ENERGY VIRON ENERGY SERVICES	4/3/2001	Remodel For Efficiency Interior Lighting	TIFF
94	LAVC_Central Plant_Azalia	10/14/09	-	CMS ENERGY VIRON ENERGY SERVICES	7/9/2001	Building 7 Electrical Diagram & Mechanical Schedule	TIFF
95	LAVC_Child Development Center Playground Improvement Project	10/14/09	-	Martinez & Amador	8/7/2001	CDC Demolition Plans	TIFF
96	LAVC_College Pool Replaster _Petra	10/14/09	-	Jones & Madhavan Consulting Engineers	7/24/1997	Pool Replaster	TIFF
97	LAVC_Hard Ceiling Retrofit_Michael	10/14/09	-	P2S Engineering/designwest Architecture	12/16/2004	Architectural ,Electrical, General, Mechanical (DSA Back Check)	TIFF
98	LAVC_Hazardous Chemical Storage Upgrade_Azalia	10/14/09	-	TDM Architects	8/15/2002	Science & Chemistry Buildings Architectural, Electrical. (Stamp drawings)	TIFF
99	LAVC_Irrigation Controllers Replacement	10/14/09	-	P2S Engineering	11/19/2004	Site Plan Irrigation Controller Replacement (electrical) BID Submittal	TIFF
100	LAVC_Junior College Grounds Improvements_North of Southwest Area_Michael	10/14/09	-	H.C. Chamber and Lester Hibbard Architects	3/17/1958	"Approved Drawings", Sewer,Gas,Electrical, Architectural	TIFF
101	LAVC_Mechanical Ventilation and Substation Replacement Phase I and II_Flavio	10/14/09	-	Nabih Yousseff & Assoc, KLG\Holland,LLC,	2/28/1997	Electrical, Mechanical and Structural Stamped Drawings	TIFF
102	LAVC_Mechanical Ventilation Phase I and II_ili	10/14/09	-	KLGHolland,LLC,	2/28/20097	Addendum Mechanical Demolitions	TIFF
103	LAVC_Michael	10/14/09	-	LAVC	-	Electrical, Plans	TIFF
104	LAVC_Placement of (7) Relocatables at (6) Sites for the Child Development Center_cody	10/14/09	-	WLC Architects	5/21/1999	Architectural, Electrical, General, HVAC, Plumbing (Not Completed Set)	TIFF
105	LAVC_Plot Plan_Petra	10/14/09	-	LAVC	9/13/1976	Plot Plan Campus Map	TIFF
106	LAVC_Replace AC Units At South Library_Azalia	10/14/09	-	KLGHolland,LLC,	2/16/1999	Mechanical Drawings	TIFF

**LAVC Utility Master Plan - Data Collection Log**

No.	Description	Date Received	Project Status	Prepared By	Document Date	Document Description	Type of Copy
107	LAVC_Replace Campus Fire Alarm System	10/14/09	-	TOFT WOLFF FARROW Inc. Electrical Engineering	3/12/1997	Fire Alarm Riser Plan Submittal	TIFF
108	LAVC_Replace F Street Sewer Lines	10/14/09	-	P2S Engineering/designwest Architecture	-	Approved Drawings, Architectural, Mechanical. (SEWER NOT INCLUDED)	TIFF
109	LAVC_Replacement of Roofing on Monarch Hall	10/14/09	-	Newman-Shahrdar Associates.	-	Roof Demolition Plans	TIFF
110	LAVC_Upgrade Life Science Chemical Stockroom_Petra	10/14/09	-	TMD Archites/Horiuchi and Associates.	3/14/1997	Architectural, Electrical , General, Mechanical, Plumbing Stamp Drawings	TIFF
111	LAVC_Valley Market Place_Emigdio	10/14/09	-	KLGIHolland,LLC,	4/9/1999	Architectural, Electrical , General, Mechanical, Plumbing Stamp Drawings	TIFF

**REQUESTED DOCUMENTS - NOT YET PROVIDED**

- 1 Gym Complex Renovation Phase 2 - Redesign DSA Submittal (to be available mid-October from Langdon Wilson Architects)
- 2 Allied Health Building – PDF copies of the redlines from the contractor
- 3 Family Resource Center – DSA Approved Bid Documents
- 4 Copies of the contractor redlines for the installed utility systems at the CDC project site
- 5 Copies of the Gym Complex Renovation Phase 2 DSA submittal set (See Item 1 in Campus Documents)
- 6 Record plans/information for the Weight Room/Gymnastic Center Building at the athletic complex east of Ethel Ave.
- 8 Record utility plans (i.e. storm drain and sewer) of the Fulton Entrance
- 9 Southland Group's study on the Central Plant system

## **APPENDIX C**

### **Los Angeles Department of Water and Power (LADWP) Water Service Data**

*(Page Intentionally Left Blank)*

**TABLE C-1: LADWP Water Service Data  
(Provided by LADWP on 11/25/2009)**

**WATER METER INFORMATION**

Los Angeles Valley College  
5800 Fulton Avenue, Los Angeles 91401  
1LOS151301  
11/20/2009 - dhewlett

Location No.	Address	Meter No.	Service No.	Size	Type	Pressure		Location	Notes
						High	Low		
1	5800 Fulton Av	40588	585100	6"	Fire	170	107	E side of Fulton Ave., 397' N/CL Hatteras St. L/W	assume zero usage
2	5800 Fulton Av	41471	575943	8"	Fire	180	117	W side of Ethel Av., 1159' N/CL Burbank Blvd.	assume zero usage
3	5800 Fulton Av	40274	582131	6"	Fire	177	112	E side of Ethel Av., 743' N/CL Burbank Blvd.	assume zero usage
4	5700 Fulton Av.	96101531	3189997	4"	Domestic	177	115	E side of Fulton; 700' N/CL of Burbank	received bills; meter no. used to be 3409891
5	5800 Fulton Av.	844	3222366	6"	Fire	174	109	E side of FULTON AV, 641' S/CL Oxnard St.	bills indicate zero usage
6	5800 Fulton Av.	40846	585099	6"	Fire	175	113	E side of FULTON AV, 46' S/CL Hillview Park Ave. L/W	assume zero usage
7	5800 Fulton Av.	244	3228239	6"	Fire	170	107	S side of Oxnard St., 510' W/CL Ethel Av.E	bills indicate zero usage
8	5900 Fulton Av.	90119288	3189995	3"	Domestic	177	115	E side of Fulton Av., 398' S/CL Oxnard St.	received bills
9	5800 Fulton Av.	244	595186	6"	Fire	170	107	E side of Fulton Av., 30' S/CL Hillview Pk	assume zero usage
10	5800 Ethel Av.	5032955	3009962	6"	Fire	175	113	E side of Ethel Av., 1169' N/CL Burbank St.	bills indicate zero usage
11	5800 Ethel Av.	90158297	579019	3" EQ	Domestic	175	113	W side of Ethel Av., 780' S/CL Oxnard St.	use bldg sf to assume usage
12	5931 Ethel Av.	31613248	3193097	2"	Domestic	175	115	W side of Ethel Av., 416' S/CL Oxnard St..	received bills
13	5780 Ethel Av.	90158338	3189999	3"	Domestic	177	117	E side of Ethel Av., 1241' N/CL Burbank	received bills
14	5760 Ethel Av.	90158426	3190000	3"	Domestic	177	117	E side of Ethel Av., 1141' N/CL Burbank Blvd.	received bills
15	5695 Ethel Av.	40859	569706	6"	Fire	180	117	W side of Ethel Av., 355' N/CL Burbank Blvd.	assume zero usage
16	5730 Ethel Av.	90158319	578268	3" EQ	Irrigation	180	117	E side of Ethel Av., 736' N/CL Burbank Blvd.	assume zero usage
17	5720 Ethel Av.	96101603	3108783	4"	Domestic	180	117	E side of Ethel Av., 732' N/CL Burbank Blvd.vd.	received bills; meter no. used to be 2653275
18	5695 Ethel Av.	96101001	587269	4"	Domestic	180	117	W side of Ethel Av., 343' N/CL Burbank Blvd.	use bldg sf to assume usage
19	5695 Ethel Av.	40845	586586	6"	Fire	180	117	W side of Ethel Av., 350' N/CL Burbank Blvd.	assume zero usage
20	5695 Ethel Av.	90141903	587270	1-1/2"	Irrigation	180	117	W side of Ethel Av., 341' N/CL Burbank Blvd.	assume zero usage
21	12951 Burbank Blvd.	43081918	3026057	1"	Domestic	177	116	N side of Burbank Blvd., 510' W/CL Coldwater Cyn	bills indicate zero usage
22	12951 Burbank Blvd.	90158324	578269	3" EQ	Domestic	178	115	N side of Burbank Blvd., 711' E/CL Ethel Av.	assume zero usage
23	13165 Burbank Blvd.	90010468	3189996	6"	Domestic	177	112	N side of Burbank Blvd., 603' E/CL Fulton Ave.	received bills
24	13135 Burbank Blvd.	90151287	3108784	3"	Domestic	180	117	N side of Burbank Blvd., 355' W/CL Ethel	received bills

Luis Nuno: 213-367-1235

Information hereon provided by LADWP on November 25, 2009.

Location Numbers provided hereon correspond to attached Figure C1, but do not correspond to Point of Connection numbering system provided in Sections 3 and 4 of the LAVC Measure J Utility Master Plan Report

*(Page Intentionally Left Blank)*

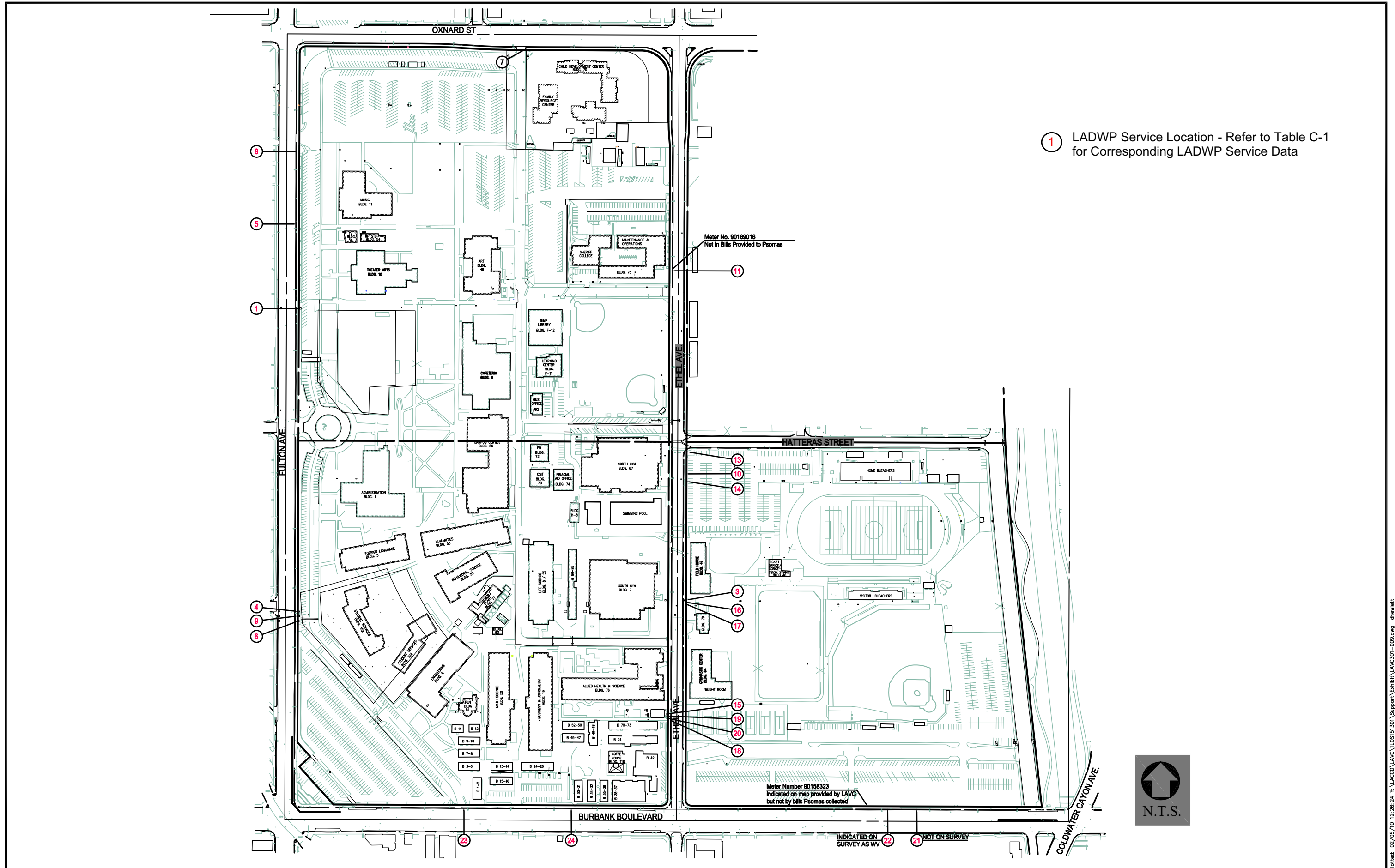
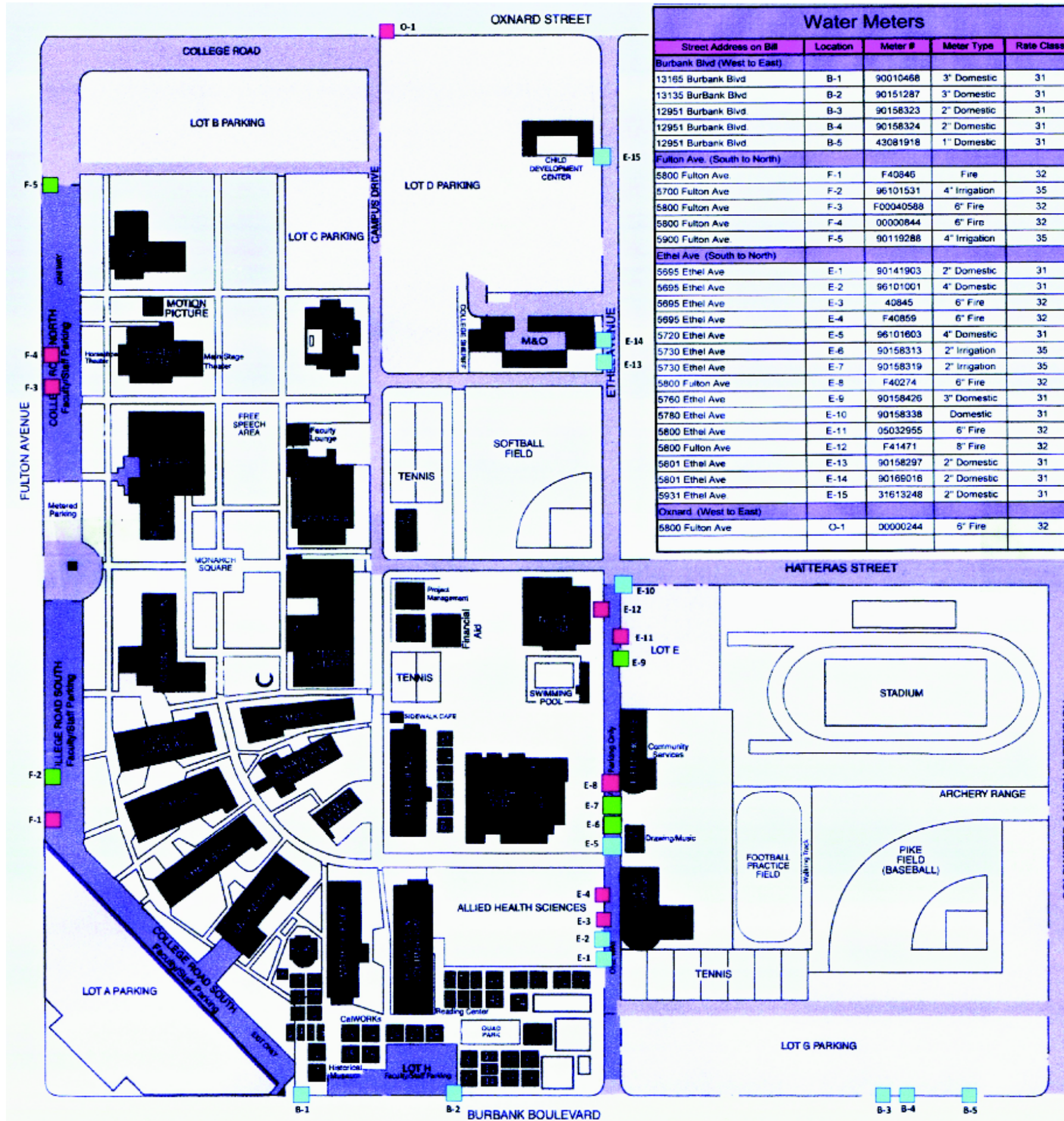


FIGURE C1: LAVC Water Service Location Map

*(Page Intentionally Left Blank)*

LAVC Campus Water Meter Map  
(Provided by Campus Facilities on 2/4/2010)



Water Meters				
Street Address on Bill	Location	Meter #	Meter Type	Rate Class
<b>Burbank Blvd (West to East)</b>				
13165 Burbank Blvd	B-1	90010468	3" Domestic	31
13135 Burbank Blvd	B-2	90151287	3" Domestic	31
12951 Burbank Blvd	B-3	90158323	2" Domestic	31
12951 Burbank Blvd	B-4	90158324	2" Domestic	31
12951 Burbank Blvd	B-5	43081918	1" Domestic	31
<b>Fulton Ave. (South to North)</b>				
5800 Fulton Ave	F-1	F40846	Fire	32
5700 Fulton Ave	F-2	96101531	4" Irrigation	35
5800 Fulton Ave	F-3	F00040588	6" Fire	32
5800 Fulton Ave	F-4	00000844	6" Fire	32
5900 Fulton Ave	F-5	90119288	4" Irrigation	35
<b>Ethel Ave. (South to North)</b>				
5695 Ethel Ave	E-1	90141903	2" Domestic	31
5695 Ethel Ave	E-2	96101001	4" Domestic	31
5695 Ethel Ave	E-3	40845	6" Fire	32
5695 Ethel Ave	E-4	F40859	6" Fire	32
5720 Ethel Ave	E-5	96101603	4" Domestic	31
5730 Ethel Ave	E-6	90158313	2" Irrigation	35
5730 Ethel Ave	E-7	90158319	2" Irrigation	35
5800 Fulton Ave	E-8	F40274	6" Fire	32
5760 Ethel Ave	E-9	90158426	3" Domestic	31
5780 Ethel Ave	E-10	90158338	Domestic	31
5800 Ethel Ave	E-11	05032955	6" Fire	32
5800 Fulton Ave	E-12	F41471	8" Fire	32
5601 Ethel Ave	E-13	90158297	2" Domestic	31
5801 Ethel Ave	E-14	90169016	2" Domestic	31
5931 Ethel Ave	E-15	31613248	2" Domestic	31
<b>Oxnard (West to East)</b>				
5800 Fulton Ave	O-1	00000244	6" Fire	32



*(Page Intentionally Left Blank)*

## **APPENDIX D**

**LAVC Measure J Utility Master Plan – Review Workshop Meeting Notes, April 8, 2010 and April 14, 2010**

*(Page Intentionally Left Blank)*

**MEETING NOTES****PROJECT: LOS VALLEY COLLEGE (LAVC) - UTILITY MASTER PLAN****PSOMAS PROJECT NO. 1LOS151301****Subject: Draft Report Review Meeting with College Facilities****Date: April 8, 2010****Location: LAVC M&O Conference Room**

Meeting held on Thursday, April 8, 2010 from 8:30 AM to 12:00 PM at LAVC CPM Conference Room

**1. Attendance**

- See attached sign-in sheet for attendees

**2. Project Status Overview and General Discussion**

- Psomas gave a project overview. The Utility Master Plan report has been completed and includes preliminary analysis on the existing and proposed utility system based on development of the Measure J Master Plan. The Utility Master Plan is referred to herein as the report.
- The report does not include complete existing utility base map plans. The existing utility plans will be a separate deliverable and campus facilities will have another chance to review the plans.
- The Psomas survey crew is currently completing final validation and corrections to the surface indications survey which will be the basis for the existing utility plans.
- Psomas had a pothole crew on-site last week to pick up information regarding the existing sewer system. Pothole scope of work included potholes, radio transmission to locate the lines and video. The pothole report should be completed by Friday and copies will be provided to the CPM and Campus facilities.
- Life Science building name to be verified. Building names within the report shall match the Steinberg Master Plan.
- The existing utility plans shall be a useful tool for the campus facilities department. Tom has requested that the plans illustrate locations of water valves (domestic/fire, chilled and hot water).
- The storm drain existing utility plans shall indicate locations of existing catch basins and outfall locations. This will be a helpful tool for facilities when applying for the college's small MS4 permit. Psomas has been contracted under a separate contract to complete a campus Storm Water Master Plan which will also address items related to the regional water board regulations and requirements.
- The Utility Master Plan and existing utility plans shall be part of the Design-Build RFPs as reference documents.
- When the existing utility plans are complete, campus facilities requests PDF and CAD files as well as two half-size and two full-size drawing sets.
- Psomas shall provide a note on the report figures stating that they are graphical depictions of the campus utility system and the existing utility plans shall be referred to for more exact information.
- Recommendations within the report should be categorized as "must do", "should do" or "would like to do".

- The key maps shown on various report figures shall be in color to better illustrate where on campus the specific figure is illustrating.
- Athletic Complex Buildings V-13 and V-14 are in design and will be built together. Psomas has requested copies of the current design from URS/Yang.
- As-builts of the Allied Health building have not been provided. In lieu of as-builts, the exiting utility plans will represent the bid document utility configurations and layouts with edits made based on discussions with the CPM and Campus facilities.
- The CDC, Library and Student Services complexes are currently under construction. They are represented in the report as existing buildings and the utility systems from the DSA approved plans are represented in the report figures (with minor edits made based on discussion with the CPM). The existing utility plans will not reflect the utilities constructed with these buildings at this time. Once as-builts are completed, Psomas and P2S have scope/fee set aside to update the existing utility plans as directed by the CPM.

**3. Review of Proposed Findings and Recommendations****➤ Sanitary Sewer**

- There is a sewer main adjacent to student services that is shown to have a negative flow. The report identifies this main to be replaced. ("must do").
- Per campus facilities, Buildings 50 and 51 currently discharge to the sewer main which discharges to Fulton Ave. The report specifies connecting these buildings to the existing sewer main which serves the bungalow buildings and discharges to Ethel Ave. Psomas to review the reasoning and evaluate the utility as-builts previously provided.
- The existing sewer main which serves the bungalow buildings is cast iron.
- There is an existing 6" lateral serving Building 56 at the north-east end which continually has problems and clogging issues. The existing trees adjacent to the service line may be the source of the problem. Psomas is to review and make recommendations in the report.
- As shown in the Media Arts/Performing Arts (MAPA) Schematic Design set, the sanitary sewer service lateral for the MAPA building is shown connecting to an existing 4" sewer. Based on the sanitary sewer system analysis provided in the report, this proposed POC is inadequate and Psomas recommends connecting the MAPA building to the existing 8" sewer main in Campus Dr. This would require extending the existing 8" sewer main to the north.

**➤ Domestic and Fire Water**

- Existing utility plans shall show the existing domestic and fire water valves. The Psomas survey identifies all the valves installed with a surface indicator (i.e. valve box). Psomas to look at identifying the valve locations within the utility tunnel. Each building has a separate valve within the tunnel and there are also valves to control sections of the domestic water system within the tunnel.
- The combined DW and FW main coming from the DWP connection at Burbank Blvd is an old steel line and is corroding. This should be replaced in the future. ("should do")
- There is an existing 2" domestic water main which provides a connection between the utility tunnels at the south end adjacent to buildings 19 and 8.
- There is an existing 4" domestic water main which provides connection between the tunnels at the north end adjacent to buildings 10 and 48.

- Psomas to review a second option to provide the second DWP domestic water connection from Oxnard rather than Fulton. Although a Fulton connection would have a shorter distance and lower cost.
- A pressure regulator will be needed at the new DWP connection to maintain a campus pressure of 70psi. The existing domestic water system is regulated at the central plant.
- If the 3" loop for the facilities east of Ethel is not needed to provide increased pressure than it may not warrant the cost to provide it.
- Psomas recommends abandoning 4-5 existing domestic water DWP meters. This will be further clarified with specifics in the final report.

➤ **Irrigation Water**

- Campus facilities requests that the irrigation control valve station locations and whether they are wireless be shown on the existing utility plans. P2S completed a plan showing all locations of the ICVs four years ago. Psomas to review P2S plan.
- The main irrigation water loop is steel pipe.
- POC DW-5 is an irrigation POC which serves the 1.5" irrigation main that connects to the stadium system.

➤ **Telecommunications**

- Brief Overview was given. A Separate Meeting with the IT group is to be held early next week.
- Julie requests that the communication plans address fire alarm and security. The fire alarm conduits are in a separate duct bank from the data and communications. This will be discussed further during the IT review meeting.

➤ **Natural Gas**

- There are eight existing gas meters serving the campus.
- Campus facilities request that the gas meter numbers and which buildings/facilities they served are listed in both the report and the existing utility plans.
- The 4" gas main in Campus Dr is a Gas Company gas main, not owned by LAVC.
- The natural gas connection for the new CDC shall be shown on the report figures as existing.
- P2S to evaluate connecting buildings V-13 (Athletic Training Facility) and V-16 (Multi Purpose Center) to meter 5 since meter 5 needs to be upsized and run a high or medium pressure line across Ethel. This would eliminate the need to provide an additional Gas Company connection in Ethel Ave. for building V-13 and V-16.
- Campus facilities would like us to include a recommendation to replace the existing older gas main north of Monarch Square in the mall area when a project becomes available to do so (i.e. if the mall area is renovated).

➤ **Chilled Water**

- There are cold water valves for each building. Existing utility plans shall identify their locations.
- The Life Science building needs connection to a 4 pipe system. It currently only has connection to a 3 pipe system and there are problems with temperature comfort levels. ("should do")

- Campus facilities would like a full loops system of 6" chilled water pipe to be provided at the north end of the tunnels. The current loop is only 3". The current 3" loop connector would be closed by existing isolation valves after the 6" loop connector is installed. ("must do")
- The North Gym is currently not connected to the campus chilled water and hot water systems. The campus would like this building to be connected to the systems. Report analysis and recommendations to be updated accordingly.
- Chilled water system model shall be updated to include keeping the Life Science building on-line and demolishing the Theatre building.
- There is plan to bring communication conduit between the gym buildings, across Ethel to serve the new athletic complex buildings, P2S shall review continuing the chilled and hot water supply/return from the main central plant system in the same configuration to the complexes east of Ethel. Two models will be run for the report to evaluate affects on the central plant. 1) To connect the new buildings east of Ethel to the main central plant and 2) to provide a satellite stand alone central plant system for the new buildings east of Ethel.

➤ **Hot Water**

- Hot water piping for the solar tubes shall be reflected. These were installed by Chevron and are located at the No. Gym and Campus Center.
- There are hot water valves for each building. Existing utility plans shall identify their locations.
- The North Gym is currently not connected to the campus chilled water and hot water systems. The campus would like this building to be connected to the systems. Report analysis and recommendations to be updated accordingly.
- There is plan to bring communication conduit between the gym buildings, across Ethel to serve the new athletic complex buildings, P2S shall review continuing the chilled and hot water supply/return from the main central plant system in the same configuration to the complexes east of Ethel. Two models will be run for the report to evaluate affects on the central plant. 1) To connect the new buildings east of Ethel to the main central plant and 2) to provide a satellite stand alone central plant system for the new buildings east of Ethel.
- The Allied health building needs hot water year round so the campus installed new control valves in the utility tunnel to control the hot water system and serve only the Allied Health building during certain times of the year. The mini hot loop for AHS must be shown on the utility map along with the valves for this mini loop

➤ **Central Plant**

- Campus facilities mentioned that the existing pumps within the central plant are only 40hp based on the pump labels. P2S to visit the plant and review actual sizes of the pumps. The central plant analysis will reflect the built conditions not what Chevron shows in their plans (P2S to review).
- The campus facilities would like P2S to evaluate the central plant system and provide enough reserve to cover a 40,000 square-foot building from Steinberg Master Plan Horizon 2 and additional 10%. This will come to approximately 20% reserve.
- The Central Plant section of the report shall include a figure illustrating the floor plan and layout of the central plant. This information is available from Chevron. If Psomas and P2S can not find it in the data previously collected, Rob will assist to provide the floor plan information.
- The report shall provide recommendations for expansion of the central plant system at each phase of construction as identified in the executive summary.
- The high student loads are from 7am-11am and after 6pm. It is not consistent with the peak demand times of 12-75pm. P2S to consider this in their analysis.
- Campus facilities has asked that P2S evaluate expanding the operating time for the sun chillers.



*(Page Intentionally Left Blank)*

**MEETING NOTES****PROJECT: LOS VALLEY COLLEGE (LAVC) - UTILITY MASTER PLAN****PSOMAS PROJECT NO. 1LOS151301****Subject: Draft Report Review Meeting with College IT Group****Date: April 14, 2010****Location: LAVC M&O Conference Room**

Meeting held on Wednesday, April 14, 2010 from 8:30 AM to 9:30 AM at LAVC M&amp;O Conference Room

**1. Attendance**

- See attached sign-in sheet for attendees

**2. Project Status Overview and General Discussion**

- The Psomas survey crew has picked up all pull boxes as part of the utility surface indications survey completed late last year. The pull boxes are not shown on the report figures due to size of the figures, but they will be shown on the existing utility plans.
- Any updates or changes to be added to the existing utility plans or report shall be provided to the CPM and Rob will notify the team.
- The LACCD data standards shall be followed and coordinated with. P2S is familiar with the standards and shall reference them in the report.
- Providing building plans illustrating the interior IDF and Data room layouts and wiring configurations is currently not part of P2S/Psomas scope of work; however it is something the college would find very useful. Aaron to speak to Rob separately about this.
- The report contains a general recommendation to install emergency phones (i.e. Blue phones) around campus for student safety. This recommendation can be coordinated with the Master Planning architect and the future Design-Build projects.

**3. Review of Proposed Findings and Recommendations****> Telecommunications**

- P2S to re-verify whether there is 200 pair installed between the campus data centers.
- Overview and mapping of the existing fire alarm system shall be shown in the Telecomm. Section of the Utility master Plan report. Fire alarm panels are located in the M&O and Central Plant buildings. Campus Facilities to verify this.
- The existing campus four multi-mode fibers are old and unusable.

- A 24 single-mode/24 multi-mode system has been installed on campus to serve a majority of the buildings. These can be used for security, CATV and other systems; however P2S to verify whether they can be used for the fire alarm system. There may be a code compliance issue.
- FA is on a separate 6 multimode fiber loop system for a majority of the buildings. The 6 fiber currently runs in the same conduit as the 24 single-mode/ 24 multimode fiber system.
- The college feels that the report recommendations are too stringent. The recommendations will be re-written to indentify the obstacles and potential issues with developing the full Measure J Master Plan Build-out and then provide "recommended options" for addressing the issues.
- When the current Administration building is demolished per the Measure J Master Plan, the current data center will need to be relocated either temporarily or permanently. The following are three options discussed: 1) Relocate the data center to its own permanent stand alone building; 2) Relocate the data center temporarily by combining it with the Campus Center data center and building a new data center in the new Administration building; and 3) Review the LRC which is currently under construction for potential capacity to fit the data center within the LRC building.
- New fiber is currently being installed form the Community Center to the football office – single mode, 6 strands.
- The existing infrastructure between the South Gym and the Financial Aid office needs further review. This area contains a lot of unknowns. Once the existing utility plans are completed. P2S will review the area in further detail with the college.
- The majority of buildings east of Ethel Ave are not connected to the main campus IT infrastructure.
- The college would like to see a direct connection with conduits from the Alpha Data Center to feed the buildings in the North Gym area.
- The telecommunications system within the tunnel is connected mainly through the power plant. There are three duct banks providing alternative connections between the tunnels with empty conduits. P2S will review recommendations for rerouting of data to avoid running through the power plant and providing shorter runs.
- The report shall be revised to state that a majority of the campus is Voice over IP ready and the college is currently in the process of a campus conversion.

**Notes Prepared: April 19, 2010**

The preceding notes were prepared by Psomas and are interpretations of items discussed and decisions reached at the above referenced meeting. Any persons desiring to add or otherwise change the minutes, are asked to send their comments in writing to [Alysen Weiland](mailto:aweiland@psomas.com) at Psomas (aweiland@psomas.com) and/or (Fax (213) 223-1444) no later than one week following the date minutes were prepared; otherwise the minutes will stand as written.

Los Angeles Valley College  
UTILITY MASTER PLAN

Psomas Project 1LOS151301

April 14, 2010

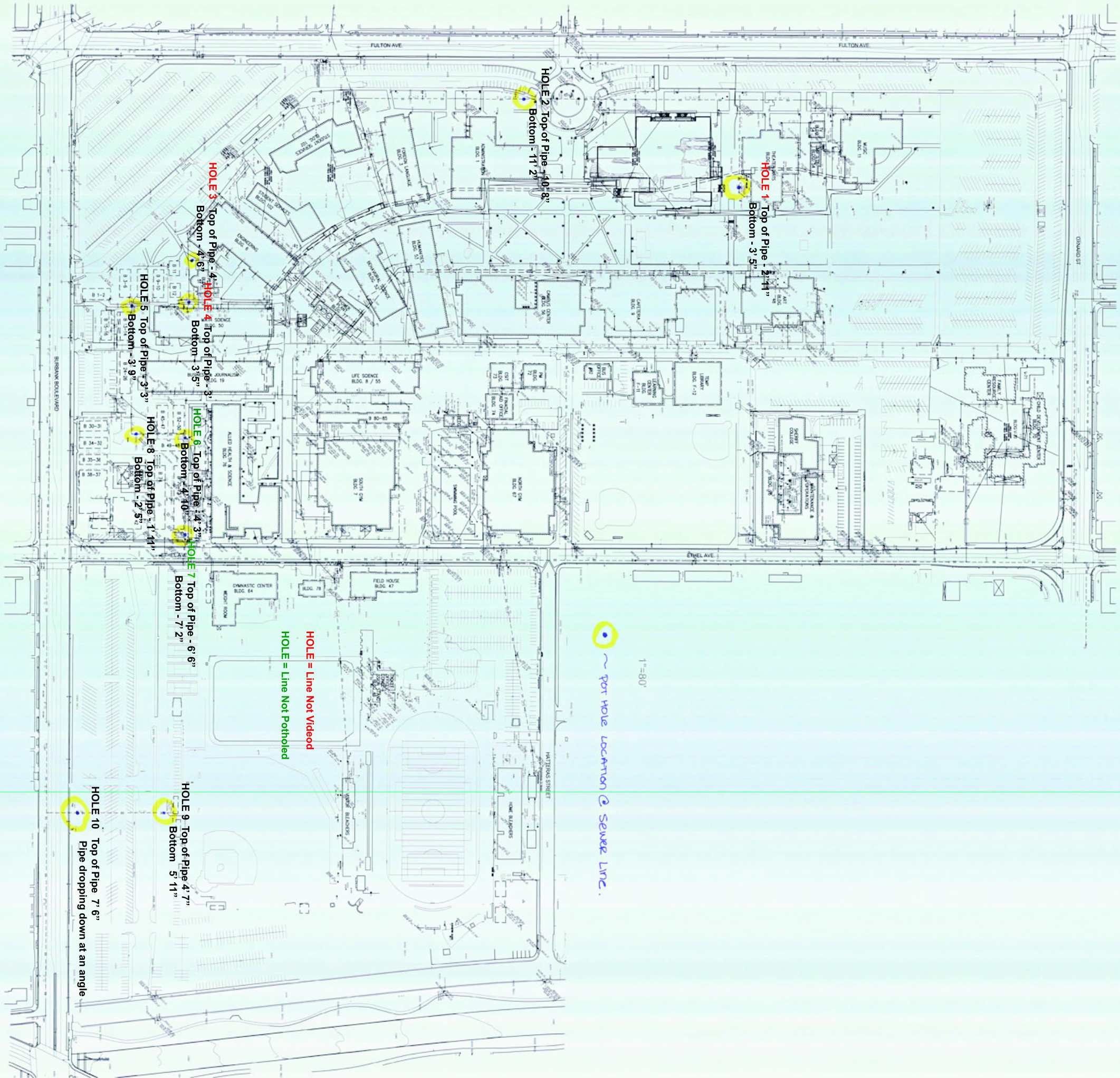
SIGN-IN-SHEET

NAME Print and Sign your Name	ORGANIZATION Print Organization	CONTACT
Alysen Weiland	PSOMAS	Email: aweiland@psomas.com Phone: 213-223-1400 Fax: 213-223-1444
<del>Alysen Weiland</del>		
Julie Fuller	LAVC-IT	Email: fullerj@lavc.edu Phone: 818 778-5671 Fax:
<del>Yeferon Kozin</del>	<del>LAVC-IT</del>	
Yeferon Kozin	LAVC-IT	Email: KOZIN44@LAVC.EDU Phone: (818) 947-2555 Fax:
Aaron Weathers	LAVC-IT	Email: WEATHERA@LAVC.EDU Phone: Fax:
Nick Giglia	LAVC-IT	Email: gigliant@lavc.edu Phone: 818 778 5513 Fax:
ED STOECKER	LAVC-IT	Email: STOECKER@LAVC.EDU Phone: 818 947-2317 Fax:
Rob Illingworth	YANG MGMT	Email: Phone: Fax:
Larry Giller	P2S Eng	Email: larry.giller@p2seng.com Phone: 562-547-6267 Fax:
		Email:
		Phone:
		Fax:
		Email:
		Phone:
		Fax:
		Email:
		Phone:
		Fax:
		Email:
		Phone:
		Fax:
		Email:

## **APPENDIX E**

### **Sanitary Sewer Pothole Report**

*(Page Intentionally Left Blank)*



*(Page Intentionally Left Blank)*



# PSOMAS

555 South Flower Street  
Suite 4400  
Los Angeles, CA 90071  
213.223.1400  
[www.psomas.com](http://www.psomas.com)

