

LOS ANGELES

TRADE

TECH

COLLEGE

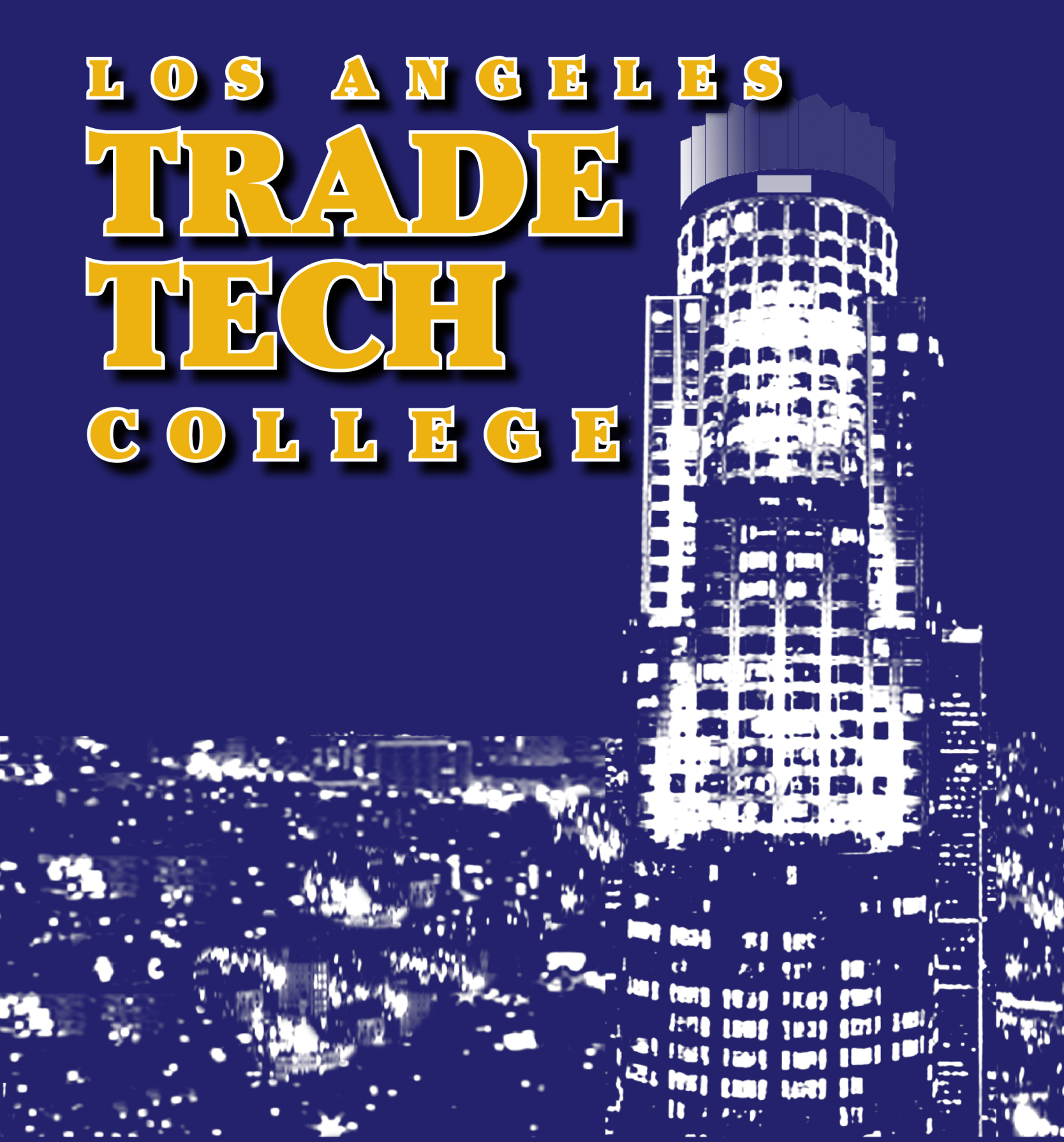

**2010 SPRING
SCHEDULE OF CLASSES**

Important Dates

Spring 2010

Registration

EOPS/DSPS Students.....begins November 23-25, 2009
Continuing Students (on-line).....begins November 30, 2009
New Students (on-line).....begins December 14, 2009
In Person Registration.....begins January 25, 2010
Open enrollment in the R - Building.....begins January 25, 2010

Spring 2010 Semester

Begins.....**February 8, 2010**

Ends.....**June 7, 2010**

First day to submit Application for Graduation.....**February 8, 2010**

Last Day To/For:

Add for semester length courses..... February 19, 2010
Refund February 23, 2010
Drop with a refund or without paying the fees..... February 23, 2010
Drop without a "W" in person..... March 5, 2010
Drop without a "W" by WEB March 7, 2010
Drop with a "W" In Person..... March 7, 2010
Drop with a "W" using the WEB..... March 9, 2010
File for Pass/No Pass March 19, 2010
Submit Application for Graduation..... March 26, 2010

Holidays - No Classes

Presidents Holiday.....February 12-15, 2010
Cesar Chavez Day March 31, 2010
Spring Recess..... March 29 - April 5, 2010
Memorial Day May 31, 2010

Final Examinations:

- See Final Exam Schedule on page 96.

Room Changes:

- Due to ongoing construction, rooms may have changed after the schedule was printed. Please check the college website (www.lattc.edu) for updates.

Remember: It is the student's responsibility to drop their classes.

Open Enrollment

Unless specifically exempted by law, every course for which State Aid is claimed is fully open to any person who has been admitted to the college and who meets the appropriate recommended academic prerequisites.

Accreditation

Los Angeles Trade-Technical College, a California public, tax-supported community college, is officially accredited by the Western Association of Schools and Colleges and is fully approved by the Board of Governors of the California State University and independent colleges and universities to give full credit for appropriate courses completed. The Culinary Arts program is also accredited by the American Culinary Federation and Educational Institute. The Registered Nursing program is also accredited by the National League of Nursing.

LATTIC

Refund

Request any allowable refund for classes from the College Business Office.

Full refund - 10% of class time usually during the first week of instruction. **No refund thereafter. Enrollment fees will be charged for classes dropped after this deadline.**

Admissions Office Hours

Monday - Thursday.....8:30 a.m. - 7 p.m.

Friday:.....8:30 a.m. - 3 p.m.

Business Office Hours

Monday - Thursday.....8:30 a.m. - 7 p.m.

Friday:.....8:30 a.m. - 3 p.m.

Counseling Center Hours

Monday - Thursday.....8:00 a.m. - 7 p.m.

Friday:.....8:00 a.m. - 3 p.m.

Accuracy Statement

The Los Angeles Community College District and Los Angeles Trade-Technical College have made every effort to make this schedule accurate and may, without notice, change general information, courses, or programs offered. The reasons for change may include student enrollment, level of funding, or other issues decided by the district or college. The district and college also reserve the right to add, change, or cancel any rules, regulations, policies and procedures as provided by law.

A MESSAGE FROM THE PRESIDENT



Welcome to Los Angeles Trade-Technical College!

We are so happy you have selected our campus as a place to further your educational journey. This community college is very unique in the fact that it offers a wide variety of award-winning career-technical programs, while at the same time providing tremendous transfer education classes. No matter what your career path, we have something here for you.

This schedule contains most of the course offerings for this semester including online classes, evening and weekend courses and information about the college itself. You have chosen a very special time to attend Trade Tech, because we are undergoing a massive construction program which will both upgrade many of our facilities and provide new facilities to enhance the student experience.

We encourage you to take advantage of the Writing Center, the math and reading labs and the computer centers. Make sure you apply for financial aid and inquire about our student service programs designed to insure your success. Get involved in the Associated Students Organization or one of the many clubs on campus. Trade Tech has a lot to offer, and we are here to serve you.

Thanks again for choosing our campus and making Trade Tech your community college!

Dr. Roland "Chip" Chapdelaine

President



LOS ANGELES COMMUNITY COLLEGE DISTRICT • 770 W. Wilshire Blvd., Los Angeles, California 90017 • (213) 891-2000

Board of Trustees

Mona Field,
President
Georgia L. Mercer,
Vice President
Kelly G. Candaele
Tina Park
Nancy Pearlman
Miguel Santiago
Sylvia Scott-Hayes
Rodney D. Robinson,
Student Trustee

District Administration

Dr. Tyree Wieder,
Interim Chancellor
Dr. Adriana D. Barrera,
Deputy Chancellor
John Clerx,
Vice Chancellor for Educational Support Services
Gary Colombo,
Vice Chancellor for Institutional Effectiveness
Marvin Martinez,
Vice Chancellor for Economic & Workforce Development
Larry H. Eisenberg,
Executive Director, Facilities Planning & Development

Camille A. Goulet,
General Counsel
Jeanette Gordon,
Chief Financial Officer/Treasurer

College Administration

Dr. Roland "Chip" Chapdelaine,
President
Dr. Kathleen Burke-Kelly,
Interim Vice President, Academic Affairs
Ramon S. Castillo,
Vice President, Student Services
Marcy Drummond,
Vice President, Workforce & Economic Development
Dr. Mary Gallagher,
Vice President, Administration
Leticia Barajas
Dean, Academic Affairs
Dr. Raul Cardoza,
Dean, Enrollment Management

Dr. Theda Douglas,
Dean, Student Services
Vincent Jackson,
Dean, Academic Affairs
Cynthia Morley-Mower,
Dean, Academic Affairs
Edward Afana,
Acting Dean, Research & Planning
Dorothy Smith,
Associate Dean, Student Services

TABLE OF CONTENTS

<i>Vision and Mission of LATTC</i>	3	<i>Educational Environment Policy</i>	78
<i>Spring 2010 Enrollment Process</i>	4	<i>Emergency Information</i>	78
<i>Steps to Enroll</i>	5	<i>Family Education Rights and Privacy Act</i>	78
<i>Orientations</i>	6	<i>Fee Exemption for Special Part-Time & Full-Time Students Grades K-12</i> ... 78	
<i>Registration</i>	7	<i>Freedom of Speech Area and Procedures</i>	78
<i>Fees At a Glance</i>	8-9	<i>Grades and Grade Changes</i>	79
<i>Taking the Assessment Test</i>	11	<i>Graduation</i>	79
<i>Prerequisites, Co-requisites & Advisories</i>	12	<i>Graduation Application for Degrees/Certificates</i>	79
<i>Enrollment Information</i>	13	<i>Hope Scholarship Tax Credit</i>	79
<i>Adding Classes</i>	13	<i>Limited English Proficiency</i>	79
<i>Auditing Classes</i>	13	<i>Estudiantes Con Falta de Competencia en Lengua Inglesa</i>	79
<i>Basic Skills Enrollment Limitation</i>	13	<i>Nondiscrimination Policy</i>	80
<i>Dropping/Withdrawing From Classes</i>	13	<i>Normas del Plantel Referentes a la Discriminación</i>	80
<i>Concurrent Enrollment/Class Conflict</i>	13	<i>Open Enrollment</i>	80
<i>Cancelled Classes</i>	13	<i>Parking on Campus</i>	80
<i>Course and Activity Repetition for Additional Credit</i>	13	<i>Sexual Assault</i>	80
<i>Course Repetition to Improve Substandard Grades</i>	13	<i>Smoking/Non-Smoking Policy</i>	80
<i>Course Repetition Under Special Circumstances</i>	13	<i>Social Security Numbers/Student Identification Number</i>	80
<i>International Student Admission</i>	13	<i>Standards of Student Conduct</i>	82
<i>Parking Permits</i>	14	<i>Disciplinary Action</i>	82
<i>Parking Locations</i>	14	<i>Student Grievance Procedures</i>	82
<i>Registration by Proxy</i>	14	<i>Ombudsperson</i>	82
<i>Study Load</i>	14	<i>Student Records and Directory Information</i>	82
<i>Veterans, Selected Reservist, National Guard, & Eligible Dependents</i>	14	<i>Student Rights and Responsibilities</i>	82
<i>Plan A General Education</i>	15	<i>Student Right to Know</i>	82
<i>Plan B General Education</i>	16	<i>Transcripts</i>	83
<i>CSU General Education</i>	17	<i>Verifications of Enrollment</i>	83
<i>IGETC General Education</i>	18	<i>Viewing Your Records</i>	83
<i>Educational Programs</i>	19	<i>Campus Offices & Services</i>	84
<i>Spring 2010 Schedule of Classes</i>	20	<i>Admission And Records</i>	84
<i>Web Enrollment</i>	46	<i>Bridges to Success Center</i>	84
<i>The Financial Aid Application Process</i>	49	<i>Career Center</i>	84
<i>The Ability to Benefit (ATB) Test</i>	50	<i>Child Development Center</i>	84
<i>Admissions Application</i>	55	<i>Cooperative Agencies Resources for Education (C.A.R.E.)</i>	84
<i>LATTC On-Line Classes</i>	70	<i>Counseling Services</i>	84
<i>Cooperative Education</i>	73	<i>Disabled Student Program & Services (DSP&S)</i>	84
<i>Apprenticeship Education</i>	74	<i>Extended Opportunity Program and Services (EOPS)</i>	84
<i>Instructional TV Program- The Weekend College</i>	75	<i>Financial Aid Services</i>	84
<i>Student Resolution Process</i>	76	<i>GAIN /CALWORKS</i>	85
<i>College & District Policies</i>	77	<i>Information Center</i>	85
<i>Academic Freedom</i>	77	<i>International Students</i>	85
<i>Academic Standards</i>	77	<i>Library</i>	85
<i>Accuracy Statement</i>	77	<i>Matriculation</i>	85
<i>Admission and Resident Classification of Non-Citizens</i>	77	<i>Puente Program</i>	85
<i>Diversity</i>	77	<i>Student Activities Office</i>	85
<i>Attendance</i>	77	<i>Student Employment Center</i>	85
<i>Conduct Expected of Students</i>	77	<i>Student Health Center</i>	85
<i>PASS/No PASS</i>	78	<i>Umoja Program</i>	85
<i>Drug-Free Workplace Policy</i>	78	<i>University Transfer Center</i>	85
<i>E-Mail Account for Enrolled Students</i>	78	<i>Directory</i>	87
		<i>Public Transportations</i>	94
		<i>Spring 2010 Final Exam Schedule</i>	96

Vision and Mission of LATTC

College Vision through 2015

Los Angeles Trade-Technical College (LATTC) will be a global leader known for effectively incorporating leading-edge theories, proven educational practices, hands-on experiences and technology into its career technical and professional programs. LATTC graduates will be in high demand. Many will become community and business leaders and innovators.

Our Mission is to

Provide our students and community with high-quality technical and professional educational options that flexibly meet their life-long career development and academic goals; foster a climate of life-long learning; prepare our students to participate effectively in our democratic society; and generate economic development with our educational, governmental, community, and business partners.

Our Values are

Learning

We are committed to help all students define and attain their learning objectives whether career technical, professional, transfer, or basic skills. We are dedicated to student success and judge our success by their learning outcomes. Our faculty, administration and staff commit to and attain annual learning objectives.

Excellence

We set and meet the highest standards. We anticipate change. We regularly evaluate our programs, systems, facilities, equipment and teaching methods to incorporate improvements. We recruit the best faculty and staff and commit appropriate resources and time to their continuous development.

Respect

We value diversity in perspective, thought, and culture. We believe it contributes to creative approaches and solutions to problems or opportunities. Regardless of the extent of our differences, we are inclusive, civil, and collegial with each other, our students, our community, and all others.

Integrity

We say what we mean and we do what we say. We hold ourselves accountable to each other and our community. We meet or exceed professional standards and legal requirements. We honor the public's trust by providing high quality services, while using our resources prudently and efficiently.

Teamwork

We believe that teams working collaboratively produce superior results. We foster collaborative relationships and teams, encompassing both campus-wide and external membership, to optimize the quality, acceptance, and implementation of their recommendations.

Decision-making

In the spirit of shared governance, we strive to keep the whole campus informed on emerging issues and involved in key decisions. We make sound data-based decisions that address multiple perspectives and account for short-and long-term implications.

SPRING 2010 ENROLLMENT PROCESS

FOR LATTC NEW OR RETURNING STUDENTS

Each box represents a process. For more information about the enrollment process please visit the matriculation webpage: www.lattc.edu/dept/tmat/matriculation.htm or stop by the Information Center, R-100.

- Step 1** **Fill out the application and submit it to Admissions & Records (R-100).**
Admissions & Records: 213- 763-5300. You can also fill out the application on-line at <http://www.lattc.edu/dept/TADR/admissions.htm>
- Step 2** **Take a Computerized Assessment Test for non-exempt students (C-107).**
See page 9 for hours; for more information please call 213-763-5339.
- Step 3** **Attend an Orientation.**
For orientation dates and times, see page 6.
- Step 4** **Speak to a counselor (H-130).**
The counselor will assist with course selection for semester &/or short-term sessions. To contact the Counseling office please call 213-763-7354.
- Step 5** **Register for classes.**
You may register for classes online (www.lattc.edu) any time on or after your registration appointment date. You may also turn in the Course Request cards during "In-Person Registration" in Admissions & Records, R-100 (Please see schedule for exact dates).
- Step 6** **Submit completed Board of Governor's Grant (fee waiver), to the Financial Aid Office (TN-100).**
You may also submit the FAFSA Application online in the Financial Aid Lab (K-Basement). For more information please call 213-763-7082.
- Step 7** **Go to the Business Office (K-126) to pay for required fees and obtain parking permit.**
Business Office #: 213-763-7225.
- Step 8** **Bring your current Fee Receipt to the Information Center (R-100) to obtain your free LATTC Student ID.**
For more information please call 213-763-5337.

** For more detailed explanation about the Enrollment Process, please refer to page 5.*

STEPS TO ENROLL

STEP 1: APPLY

Submit a completed application to the Admissions & Records Office in R-102.

- Documents you need to bring: Recommended: Valid photo identification; verification of immigration status for non citizens.
- For more information regarding the exemption from payment of nonresident tuition for nonresident students who have attended a high school in California and received a high school diploma or its equivalent (Assembly Bill 540), see the Information Center in R-100 or the Admissions Office in R102.
- For K-12 students who are currently attending a middle school or high school, a Supplemental Application for Admissions of Students in Grades K-12 must be submitted together with the LATTC application. These forms must be approved by an Academic Administrator. For more information, please see the Bridges to Success Center in C-108.

STEP 2: ASSESSMENT TEST

If you are registering for English, Math, or English as a Second Language (ESL) class during this semester you will need to take the Assessment Test which is offered in C-107 on a walk-in, first come, first served basis. For testing hours call (213) 763-5339.

- You need to bring a valid picture ID (no exceptions) and student ID number from the college.
- Exemption Criteria: You may be exempt from taking the assessment test if you meet and bring proof of any of the following criteria:
 - a) Valid assessment test scores from LATTC or another college taken within the last 2 years.
 - b) Completion of English 64 and Math 101 (or higher) at LATTC with a grade of "C" or better.
 - c) Transcripts which show the completion of English and Math courses at another accredited college with a "C" or better.
 - d) AP English and Calculus Exam with Scores of 3 or higher taken within the last 2 years.

STEP 3: ORIENTATION

LATTC currently offers three forms of orientation: In-person (highly recommended), CD-ROM or On-line. You may participate in any one. Please come to the Information Center for more information in R-100.

Exemption Criteria: You may be exempt from participating in orientation if earned an AA/AS or higher degree from an accredited institution. Please bring a copy of transcript or diploma to R-100 to satisfy this exemption.

STEP 4: MEET WITH A COUNSELOR

During the registration period, counselors will be available to assist students on a limited walk-in basis in H-130.

Documents you need to bring: your assessment results if you are registering for an English, Math, or ESL class.

STEP 5: REGISTER FOR CLASSES

You may register for classes any time on or after your registration appointment date and time. You may register online through the Student Information System or in-person during the In-Person Registration period in R-102. FOR SPECIFIC DATES FOR EACH METHOD OF REGISTERING, PLEASE REFER TO THE IMPORTANT DATES PAGE IN THE CURRENT SCHEDULE OF CLASSES.

STEP 6: FINANCIAL AID

You should apply for a Fee Waiver and Free Application for Federal Student Aid (FAFSA) as soon as possible!

Visit the Financial Aid Office in TN-100 (behind the Library), the Financial Aid Lab in the basement of the K-Building, Room 004, or call (213) 763-7082.

In order to qualify for financial aid you need to have a High School Diploma or GED or a passing score on the Ability to Benefit Test, which is administered in the Assessment Center in C-107.

STEP 7: PAYING FEES

You can pay for your classes (if you are not receiving financial aid), pick up your Fee Receipt, and pay for your parking permit at the Business Office in K-126.

STEP 8: LATTC PHOTO IDENTIFICATION CARD

To receive your LATTC Photo ID, please go to the Information Center in R-100.

ID Office hours: Monday thru Thursday 9:00 a.m. to 6:30 p.m.; Friday 9:00 a.m. to 12:30 p.m. For more information call (213) 763-5337.

Documents you need to bring: your LATTC Fee Receipt for the current semester.

ORIENTATIONS

Spring 2010 Orientations (semester begins February 8, 2010) **All orientations will be held in the K-Basement**

December, 2009

Wednesday, December 9th - 1 p.m.
Monday, December 14th - 10 a.m.
Thursday, December 17th - 5:30 p.m.

January, 2010

Wednesday, January 6th - 1 p.m.
Monday, January 12th - 10 a.m.
Thursday, January 14th - 5:30 p.m.
Wednesday, January 20th - 1 p.m.
Saturday, January 23rd - 10:30 a.m.
Monday, January 25th - 1 p.m.
Tuesday, January 26th - 10 a.m.
Wednesday, January 27th - 5:30 p.m.
Thursday, January 28th - 5:30 p.m.
Friday, January 29th - 11 a.m.

February, 2010

Monday, February 1st - 5:30 p.m.
Tuesday, February 2nd - 1 p.m.
Wednesday, February 3rd - 10 a.m. & 5:30 p.m.
Thursday, February 4th - 1 p.m.
Friday, February 5th - 11 a.m.
Saturday, February 6th - 10:30 a.m.

If you have any questions about the orientations, please call (213) 763-5336 or stop by the Information Center in R-100.

Please note: Orientation dates are subject to change. Please call (213) 763-5336 to verify.

REGISTRATION

FOR ALL STUDENTS THROUGH THE INTERNET

How to apply to LATTC on-line:

New & Returning Students:

Step 1: Fill out the Application:

- A. Go to www.laccd.edu
- B. Click on Admissions & Registration
- C. Click on Apply for Admission

Step 2: After submitting your application, you will receive an email response within 48 hours. You may then receive your appointment registration.

Continuing Students:

- A. Go to www.laccd.edu
- B. Click on Student Information System

Assistance for the hearing impaired

If you are Hearing Impaired and need an interpreter or other related services, please contact the Disabled Student Services at (213) 763-3773.

The screenshot shows the LATTC website interface. At the top left, it displays the college's name and address: LOS ANGELES TRADE-TECH COLLEGE, 400 W. WASHINGTON BLVD, LOS ANGELES, CA 90015, 213-763-7000. The LATTC logo is prominently featured. To the right, there are buttons for 'Apply Now' and 'Register for Classes'. Below the header is a navigation menu with links for 'Why LATTC', 'Students', 'Faculty & Staff', and 'Community'. A central banner advertises 'College @ Night' and 'FASHION DESIGN' with the text 'MASTER A TRADE EARN YOUR DEGREE'. A sidebar on the left lists various services like 'About Trade-Tech College', 'Academic Affairs', 'Admissions', etc. On the right, there are several service buttons: 'CLASS SCHEDULES & CATALOG', 'MYLATTC PORTAL STUDENT EMAIL ACCESS', 'TUTORING AND BASIC SKILLS', 'FINANCIAL AID FEE WAIVER AVAILABLE', 'ACCREDITATION COUNTDOWN', 'PARKING INFORMATION', and 'ONLINE CLASSES HYBRID & FULLY ONLINE'. A 'GO' button is located at the end of the navigation menu.

Your Appointment to Register Can be Used for ANY College in the LACCD!

With your appointment to register, you can use the college's web-based registration system to register for classes at any of the colleges in the Los Angeles Community College District (LACCD) - East L.A. College, L.A. City College, L.A. Harbor College, L.A. Mission College, Pierce College, L.A. Trade Technical College, L.A. Southwest College, L.A. Valley College, and West Los Angeles College. You can register for Instruction Television (ITV) classes as well. You do not need to apply separately in order to register at these colleges.

12,000 Classes to Choose From!

The opportunity to enroll at multiple colleges gives you access to over 12,000 classes throughout the nine colleges in the Los Angeles Community College District.

Search for Classes on the Web!

Using the college's web registration system, you can search for available classes at any college in the Los Angeles Community College District. You can even search for a particular course by time and days of the week!

FEES AT A GLANCE

Enrollment Fee

\$26* per unit for California residents, with no maximum.

* Subject to change by the California Legislature.

The State Education Code requires Community Colleges to charge enrollment fees of each student enrolling in college. The fee prescribed by these sections shall be twenty-six dollars (\$26*) per unit per semester with no maximum per semester. Non-resident students paying non-resident fees are required to pay the twenty-six dollars (\$26*) per unit enrollment fee. Fees must be paid at the time of registration or risk being excluded from class. Enrollment fee waivers are available to qualifying students. Contact the Financial Aid Office in Temporary Building TN-100 or call (213) 763 - 7082 for information about fee waivers prior to payment.

Health Services Fee

* \$11 per semester
Spring & Fall

* \$8 per semester
Summer & Winter Intersession

* Subject to change by the LACCD Board of Trustees.

The Board of Trustees has required that each college collect a mandatory eight-dollar (\$8) health services fee. This fee must be paid at the time of registration. The Los Angeles Community College District Policy exempts the following students from paying the student health fee: (a) students who depend exclusively on prayer for healing in accordance with the teaching of a bona fide religious sect, (b) students who are attending classes under an approved apprenticeship training program, (c) non-credit education students, (d) students enrolled in District colleges exclusively at sites where student health services are not provided, (e) students who are enrolled District colleges exclusively through Instructional Television or distance education classes, (f) student who are enrolled in District colleges exclusively through contract education. Students exempted under the provisions of (b), and (c) above are eligible to receive the services of the college health program; all other exempted students are not eligible to receive the services of the college health program.

Students who are exempted may obtain a Health Services Exemption Form from the Admission Office (R-100). Completed forms must be returned to the Admissions Office for approval.

Non-Resident Tuition Fee

Out-of-state students: \$188 per unit plus enrollment fee of *\$26 per unit

Foreign students: \$188 per unit plus a \$10 per unit fee and enrollment fee of *\$26 per unit

Foreign Student Processing Fee
Per semester: \$25 *Non-refundable*

The 2009-2010 tuition for non-resident students is \$188 per unit plus the \$26* per unit enrollment fee. Fees must be paid at the time of registration or risk being excluded from class.

The 2009-2010 tuition for foreign students is \$188 per unit plus the \$26* per unit enrollment fee and the Board of Trustees adopted \$10 per unit fee pursuant to Education Code Section 76140. These fees are subject to change each academic year. Foreign students must pay a non-refundable \$35 application fee.

Effective Fall Semester, 2003, the Board established a twenty-five dollar (\$25.00) per semester processing fee for students classified as nonresidents who are both citizens and residents of a foreign country.

Nonresident tuition fee exemption for students taking either a total of four (4) units or fewer or ONLY one class which is six (6) units or fewer. Beginning with the Winter 2009 semester, all nonresidents who enroll for either: (a) a total of four units or fewer, or (b) only one class which is six units or fewer, shall be exempt from the nonresident tuition fee (Board Rule 8100.15, EC 76140(a)(1)). **Note:** Fees paid by federal financial aid funds will be subject to a special refund calculation.

Resident and Non-Resident Tuition Refund Schedule

Class Type	Date Request Time Stamped	Refund
Regular Length (Fall & Spring)	Through second week of instruction	Full Refund
	After second week of instruction	No Refund
Short Term, Summer, Winter Intersession (Less than regular length)	Through 10% of class length	Full Refund
	After 10% of class length	No Refund

Auditing

\$15 per unit
Non-refundable

STUDENTS MAY BE PERMITTED TO AUDIT A CLASS UNDER THE FOLLOWING CONDITIONS:

1. Complete an application and be authorized to register in the college
2. Obtain permission of the instructor of the class at the beginning of the semester
3. Payment of a non-refundable fee of \$15 per unit (Note: No fee waivers available for audited classes)
4. No student auditing a course shall be permitted to change his or her enrollment in that course to receive credit for the course
5. Student auditing a course cannot drop the course
6. Students enrolled in classes to receive credit cannot drop after the No Penalty Drop Date to audit these classes
7. Students enrolled in classes to receive credit for ten or more semester units shall not be charged a fee to audit three or fewer semester units unless they drop below 10 units during the semester
8. Priority in class enrollment shall be given to students desiring to take the course for credit
9. If class material are provided, the student should be assessed those costs
10. There is **No refund** of AUDIT fees unless the class in which the student was auditing was cancelled by the college

Parking Permits

\$10 - Summer & Winter
\$20 - Spring & Fall

A limited number of student Parking Permits are available for purchase at the Business Office for \$20 per permit per semester for Spring and Fall, \$10 for Summer and Winter. Parking in areas marked "Parking by Permit ONLY" will be restricted to vehicles displaying a valid permit. Vehicles parking on college property without a valid permit will be subject to citation. **There is no replacement for lost or stolen permits.** There is a \$5.00 service charge for Parking Permit exchanges

ASO Fee

\$7 per semester

The \$7 ASO membership fee is automatically charged, UNLESS the student declines. This is NOT a mandatory fee. ASO fees do not apply for Summer sessions and Winter Intersession.

Student Representation Fee

\$1 per semester - *Non-refundable*

The student representation fee is a mandatory fee to provide support for student representatives who state their view points before various governmental offices and agencies. Students may for religious, political, financial or other reasons, refuse to pay the fee in writing on a form provided for this purpose.

FEES AT A GLANCE

CONTINUED

Enrollment Fee Assistance

For immediate enrollment fee assistance, students who are unable to pay the enrollment fee should complete the Board of Governors' Enrollment Fee Waiver application and submit it to the college Financial Aid Office for processing prior to payment of their enrollment fees. Students who complete a Free Application for Federal Student Aid (FAFSA) will be given an automatic fee waiver based upon the information reported on the application. There is no need to complete a paper application if you have received notification of an automatic fee waiver for the 2009-2010 school year. Go directly to the Business Office, Cashier Window, K-126, to pick-up your registration receipt. Students who had a fee waiver last year must submit a new application for the new year, which includes Summer 2009, Fall 2009, Winter-Intersession 2010, and Spring 2010. Applications are available in the class schedule, the Information Center, and the Financial Aid Office. There are three ways to qualify:

- Method A (BOG A)** – For families or students who receive TANF/CALWORKS, General Relief (GR), Supplemental Security Income (SSI/SSP).
- Method B (BOG B)** – For families or students whose family income and size fall with the following limits:

Board of Governors Fee Waiver Program (BOGFW - B) 2009 - 2010 Income Standards

Family Size	2008 Income	Family Size	2008 Income
1.....	\$15,600	5.....	\$37,200
2.....	\$21,000	6.....	\$42,600
3.....	\$26,400	7.....	\$48,000
4.....	\$31,800	8.....	\$53,400
		Each Additional Family Member	\$5,400

Special Classification Enrollment Fee Waivers:

You also be eligible for a BOG if

- you are a dependent of a deceased or disabled veteran of the U.S. Military
- you are a recipient of a Congressional Medal of Honor or a child of a recipient
- you are a dependent of a victim of the September 11, 2001 terrorist attack
- you are a dependent of a deceased law enforcement/fire suppression person killed in the line of duty.

Proof of these benefits is required.

Method C (BOG C) – Students who do not meet the above criteria, but have financial need as established by the College Financial Aid Office, may also be eligible for an Enrollment Fee Waiver. To qualify, students must complete a Free Application for Federal Student Aid (FAFSA) and provide proof of prior year income. Processing of this type of fee waiver takes approximately five working days.

Fee Exemption: Attention Board of Governors Fee Waiver Students

Beginning fall 2006, all students will be charged the health fee (\$11 for fall and spring and \$8 for summer and winter). This fee will no longer be waived for students who are eligible for a fee waiver. Please feel free to contact the Financial Aid Office on extension 7082 if you have any questions. There are no fee waivers for audited classes. Other financial aid may be available to students who meet the qualification requirements. Students with questions concerning financial aid eligibility should contact the College Financial Aid Office, Temp Building TN-100.

Refund Policy

All refunds must be requested in the Business Office (K-126).

- Full semester (Fall & Spring) refunds are issued for classes dropped through the end of the second week of instruction. Thereafter, no refund is authorized, except when college action to cancel or reschedule a class necessitates the drop.
- For all short term, Summer session, and Winter Intersession classes, a refund is issued for classes that are dropped prior to a period of time equal to 10% of the total class time, must usually be dropped during the first week of class. Thereafter, no refund is authorized, except when college action to cancel or reschedule a class necessitates the drop.
- If college expenses have been paid by federal financial aid funds, any refund due will revert to the financial aid program rather than to the student.
- The date used for refund purposes is the date on which the drop is processed, regardless of when separation may have occurred.
- All non-resident refunds will be made by mail or credit card.
- All students please check for refund disclaimer in section on course repetition.

Campus Refund Procedure

1. Student must drop class by refund deadline.
2. In order to receive a refund, the **student must request the refund in the Business Office (K-126)**.
3. There shall be no refund disbursements before the first day of the semester unless the student withdraws from all colleges in the District.
4. The campus Business Office will make no refund disbursements during the first 2 weeks of the semester.
5. Students who have paid their fees by check shall get their refunds pending verification that their checks have cleared the bank.
6. Cash refund limit is \$100.00

Instructional Materials

Students may be required to pay for or provide instructional and other materials required for a credit or noncredit course. Such materials shall be of continuing value to a student outside of the classroom setting and shall not be solely or exclusively available from the District. If class material are provided, the student may be assessed those costs for materials. Payment and verification of material fees is to be completed at the college Bookstore or Business Office K-126.

Returned Check Fee

A \$10 fee is charged for any check returned by the bank unpaid. A hold is placed on the student's record until the financial obligation is settled.



Attention Students:

Need help paying your fees?

Enrollment fees for all California community colleges are \$26 per unit.

Before you write out that check or charge your credit card, why not apply for financial aid? Did you know that:

- Many students are eligible to have their fees waived, but they don't apply.
- The eligibility criteria for fee waiver is more lenient than for Federal Financial Aid.
- If you are eligible for a fee waiver, you may request a refund of the enrollment fees you may have already paid.
- Other kinds of financial aid are available as well. Apply for financial aid in addition to the fee waiver by using the Free Application for Federal Student Aid (FAFSA) online at www.fafsa.ed.gov, or by paper application.
- By applying via the FAFSA, you will be considered for all of the financial aid programs your college participates in, including the fee waiver
- You have nothing to lose; it's a free application so don't delay, apply today!
- See center insert for full information.

The Trade-Tech

Financial Aid Office

is located in the Temporary Building,

TN-100, (213) 763-7082

Financial Aid/EOPS Computer Lab is located in

K-Building Room 004 (basement).

TAKING THE ASSESSMENT TEST

In order to help students get the most out of their higher education, the college provides tests that assess a student's general educational background and skills in: Math, English, and English as a Second Language (ESL). The Matriculation Department is concerned that you successfully complete your course work at LATTC by selecting courses that will meet your educational goals. These tests help students select courses that are realistic and compatible with their level of academic preparation and experience.

LATTC offers computerized assessment testing. The student will receive a copy of their assessment results. You may take your assessment test results to the counselors who will make appropriate course recommendations.

Assessment Center

Phone: (213) 763-5339

Location: Building C-107

Office Hours:

Monday:	9:00 a.m. to 5:00 p.m.
Tuesday:	9:00 a.m. to 5:00 p.m.
Wednesday:	9:00 a.m. to 8:00 p.m.
Thursday:	9:00 a.m. to 5:00 p.m.
Friday:	9:00 a.m. to 2:00 p.m.
Saturday:	Call for available dates and times

Please REMEMBER that during testing:

- No food or drinks
- No children
- No calculators
- Cell phones and pagers MUST be turned OFF
- All electronics devices need to be turned off.

Frequently Asked Questions:

When can I take the test?

The test is available on a walk-in basis in C-107 any time after you have submitted a current application to Admissions & Records. Please bring your LATTC/LACCD Student I.D. number.

Do I need to study for this test?

No. This is not a pass or fail test. However, it is important for a student to take the test to the best of their ability. This test affects the number of Math and English courses a student must complete in order to meet graduation/transfer requirements. If the student disagrees with scores, they have the right to challenge their test scores.

What do I need to bring with me?

Students need to bring a valid photo ID in order to take the test. There are NO EXCEPTIONS to this policy! The ID must be original, No photocopies. Examples of ID include a California Driver's License, California ID, a pass-port, high school picture ID, etc.

How long does the test take?

The test is self-paced. Most students finish in about 2 hours. Please arrive at least two (2) hours before closing time.

How long are the test scores valid?

Test scores are valid for 2 years. Retesting for General Placement of English/Math/ESL is only every two years. You may challenge your placement results.

What does it take to be exempt from taking the assessment test?

The student must meet one of the following criteria:

- Valid assessment scores from LATTC or another college taken within the last 2 years.
- Completion of English or Math courses at any accredited college with a grade of "C" or better (transcripts required).
- AP English or Calculus Exam Scores of 3 or higher taken within the last 2 years.

Transcript, test scores, or a college diploma MUST be provided as proof for assessment test exemption to the Assessment Center.

PREREQUISITES, CO-REQUISITES & ADVISORIES: YOUR PATH TO ACADEMIC SUCCESS!

Prerequisites, Co-requisites and Advisories What Do They All Mean?

Prerequisite is a condition that a student has to meet prior to enrolling in the class. Completion of the prerequisite demonstrates that you are ready and able to succeed in the course you want to take. A prerequisite is usually either another course, or a specific test score on a standardized test.

Co-requisite is a course that must be taken at the same time as the course you want to take.

Advisory or recommended preparation means that you are advised, but not required, to have taken the course(s) or met the test scores before enrolling in the class.

PLEASE CHECK YOUR CLASSES CAREFULLY:

Prerequisites are enforced!

Want to take a course with a pre-requisite? You can satisfy a prerequisite several ways:

1. Take the prerequisite course at Trade-Tech or another college in the District and achieve a grade of "C" or better, so that it shows on your official transcript;
2. Provide proof that you've successfully completed the requirement(s) at another college. You can bring transcripts or assessment scores from another school to the Matriculation Department and they will be reviewed. If your course is approved, you'll be given a clearance to register.
3. Take a test – known as a challenge exam – to show that you have the knowledge and skills necessary to successfully prepare you for the course you want to take;
4. If the course you want to take has an assessment test score as a prerequisite, you'll need to visit the Assessment Center and complete the required test. Your score will then be given to you, and the prerequisite(s) will be cleared once you receive a copy of your placement score(s).

If you have any questions or need more information, please contact the Matriculation Office at (213) 763-5348 (K-Basement Level) or visit the Assessment Center (C-107; 213-763-5339).

Challenging a Pre- or Co-requisite

If you want to challenge a prerequisite or co-requisite, i.e., you have not met the necessary prerequisite conditions but believe you should be allowed into the class anyway, you can challenge it if:

1. The prerequisite has not been made reasonably available;
2. The prerequisite is not valid because it is not necessary for success in the course you want to take;
3. The prerequisite is discriminatory or applied in a discriminatory manner;
4. You believe you have the knowledge or ability to succeed in the class without the prerequisite.

If you believe any of the above is true, you have the right to challenge the prerequisite or co-requisite. To obtain a Challenge Form, please visit the Matriculation Office or the Assessment Center and follow their directions.

ENROLLMENT INFORMATION

ADDING CLASSES

Only students who have been admitted to the College and are in approved active status may add open classes. Any applicable fees for increased units will apply.

Adding Classes Prior to the Start of the Semester - enrolled students may add a class prior to the first day of the semester/session by completing an Add/Drop Permit during the in-person registration process, or by using the web enrollment system at www.lattc.edu.

During Late Add Period - students can add an open class (or classes) by presenting a signed Add Permit to the Admissions and Records office. The Add Card must be signed by the instructor of record or their designee and returned to Admissions and Records the same day it was issued. A signed copy must be presented to the instructor at the next class meeting.

After Late Add Period - there is no petition process for late adds after the deadline, however, students may add any open entry/open exit class without an Add/Drop Permit.

AUDITING CLASSES

Classes may be audited on a space available basis. There is a \$15 per unit non-refundable fee to audit a class; for more information, please see the "Fees at a Glance" section of this schedule.

BASIC SKILLS ENROLLMENT LIMITATION

Title 5, California Code of Regulations, limits student from taking more than 30 units of "remedial" course work, which is defined as "nondegree-applicable basic skills courses." Effective Winter 2010, the college's registration system will prevent students, who have exceeded this limit, from enrolling in additional basic skills courses. However a student, who has reached this limit but enrolls in a credit or noncredit English as a Second Language (ESL) course, will be allowed to enroll in additional basic skills courses. Students with a learning disability may request an exemption through the Disabled Student Programs and Services (DSPS) Office. Also, this limitation does not apply to enrollment in noncredit basic skills courses.

CONCURRENT ENROLLMENT/CLASS CONFLICT

Students are not allowed to enroll in multiple sections of the same course during a single semester. Concurrent enrollment in cross-referenced courses is not permitted, nor is enrollment in classes scheduled or conducted during overlapping times. Students violating this regulation will be excluded from both classes and be denied course credit. They will also be subject to disciplinary action. Please see Standards of Student Conduct in the current catalog for more information.

CANCELLED CLASSES

Due to low enrollment, some classes listed in this schedule may be cancelled. If a class has been cancelled, you are eligible for a refund of any fees you have paid toward that course.

COURSE AND ACTIVITY REPETITION FOR ADDITIONAL CREDIT

Certain courses may be repeated for additional credit. These courses, marked "RPT" in the class section of the college catalog, allow the student an expanded educational experience each time the student enrolls in the course. Enrollment in these courses is limited in any activity to a maximum of

three repeats for a total of four (4) enrollments, regardless of the repeatability of individual courses. The activity limitation also applies to courses which are not repeatable in themselves but for which similar activities exist. For example, there are several similar course titles in Art, Music, Theater, and Physical Education which are considered to be the same activity. A student may enroll four times in courses which are considered to be the same activity. Any combination may be used as long as 4 enrollments in one activity is not exceeded. Please consult the current catalog for more information.

COURSE REPETITION TO IMPROVE SUBSTANDARD GRADES

Students may petition to repeat courses in which substandard grades (less than "C," 2.0) were awarded. See Catalog for details on Course Repetitions.

COURSE REPETITION UNDER SPECIAL CIRCUMSTANCES

Repetition of courses for which substandard work has not been recorded shall be permitted only upon advance petition of the student and with written permission of the College president or their designee. Please consult the current catalog for further information.

DROPPING/WITHDRAWING FROM CLASSES

Please see the inside front cover for dates to drop or withdraw from classes. **Please note:** It is the student's responsibility to drop a class they are not attending. If the class is not dropped, the student may receive an "F" in the class.

NOTICE: If you are receiving Financial Aid, you may have to repay federal funds for classes you have dropped or withdrawn from. Be sure to check with the Financial Aid Office before you stop attending classes!

INTERNATIONAL STUDENT ADMISSION

Los Angeles Trade-Technical College (LATTTC) welcomes applications from international students. We also accept transfer applications for F-1 Visa students currently studying in the U.S. as well as Change of Status applications for visitors who currently have other visas. Applications may be obtained by contacting the office or on-line. The International Students Center is located in Building R, Room 100.

Application Deadlines:

- Fall Semester: July 1
- Spring Semester: December 1

NOTE: F-1 students transferring from schools within the United States (US) have a more flexible deadline; please call the International Student office for more information.

The applicant must provide:

1. The supplemental International Students Application
2. Two recent passport sized photographs of applicant
3. Copy of valid passport identification page
4. Official TOEFL scores sent directly from Educational Testing Services - this may be waived if you are from a country that uses English as its primary language of instruction or if you are transferring from a school within the United States. We also accept the International English Language Test Skills (IELTS) report and the Step Eiken in lieu of the TOEFL. Please contact us for all test cut scores.
5. Official transcripts and/or diplomas from secondary school and colleges attended - student must be a high school/secondary school graduate. If these documents are not in English, an official translation must also be submitted.

6. LATTTC Affidavit of Support including an official bank statement or letter with a minimum of \$16,000 USD in available funds dated within the last 6 months
7. Non-refundable \$35 application fee – check, cash, or money order
8. Transfer students must also submit the following documents: the LATTTC Transfer Approval Form, a copy of your current I-20, a copy of your visa, and a copy of the front and back of your I-94.

Please allow 2 – 4 days for application processing time once ALL documents are received by the college. Eligible students will be issued an I-20A form by LATTTC. This document can be used by the student to obtain an F-1 Visa from a US Embassy in his/her home country. Students who are already in the country may use this new I-20 to change their visa status or to complete their transfer process from another educational institution.

TUITION

International student fees are approximately \$224 per unit, subject to change by the California legislature.

HEALTH INSURANCE

Health care in the United States can be costly without proper insurance coverage. Starting in the Fall 2007 semester, LATTTC International Students will be fully covered by Blue Cross. The cost for a 6-month period of coverage is \$438, which is subject to change. The \$438 will be included as part of your LATTTC fees every Fall and Spring Semester (no waivers). Please visit our office for a copy of your benefits.

FULL-TIME COURSE LOAD

Per U.S. Citizenship and Immigration Services (USCIS) regulations, all F-1 International Students must maintain a full-time course load during the Fall and Spring semesters – certain exceptions apply, please see your Designated School Official (DSO) for more information. A full-time course load is defined as a minimum of 12 units. Dropping below 12 units without PRIOR written permission from the DSO places your student status at risk. F-1 students are not required to attend the Winter and Summer Sessions but may do so if they wish.

CHANGE OF STATUS

Effective April 12, 2002, the Immigration and Naturalization Service has issued an Interim Rule which requires students with B Visas to change their visa status to an F-1 Non-immigrant Visa prior to pursuing a course of study at the college. Applicants may only enroll in classes after F-1 student status has been approved by USCIS. Also note that holders of H-1, H-2, or H-3 Visas may only engage in incidental studies per USCIS regulations. If you wish to pursue a degree, please apply for a change of status to an F-1 Student Visa. Call our office for more information.

PARKING PERMITS

Parking permit fees are \$20 during the Fall and Spring semesters. All students must still display a valid parking permit for that semester. Failure to do so will result in a parking citation. To obtain your parking permit, please visit the Business Office during normal business hours and be a currently enrolled student.

PARKING LOCATIONS

Parking is available in the LATTTC Olive Street Parking Structure located at 2001 S. Olive Street [Across the street from the "K" building; 1/2 block South of Washington Blvd, between Grand and Olive. Entrance on Olive Street.] Parking is also located at various contracted lots adjacent to the campus. Contracted parking is subject to change based on the College's construction schedule and availability. For current information, please check our website at lattc.edu, or contact the Sheriff's Department at 213/ 763-3600.

REGISTRATION BY PROXY

Applications for acceptance to the college cannot be completed and signed by any person other than the applicant. An original signature is required on the application and the applicant is responsible for the correctness. If a student requests registration by proxy, a signed, completed "PROXY REGISTRATION FORM" must be presented and surrendered (at the Admissions and Records Office, R-102) by the proxy at the time of class enrollment. This document will serve in-lieu of the student's signature normally on the Course Request Card. The student assumes all responsibility for the proxy's action during the enrollment process. Proxy Registration Forms are available upon request in the Admissions and Records Office, Room R-102. Registration by proxy does not release the student from the responsibilities for all college rules and regulations or the mandatory intake process of Assessment and Orientation.

STUDY LOAD

A maximum of 18½ units may be carried without prior approval. If a load of 18½ units or more is requested, a student must file an Academic petition in the Admissions Office Room R-102. Forms are available in the counseling office. Student benefits such as Financial Aid (6 units minimum – 1/2 benefit) and Veterans Educational Benefits are based on a minimum full time study load of 12 acceptable units. Associated Student officers and participants in conference athletics must be enrolled in at least 12 units.

VETERANS, SELECTED RESERVIST, NATIONAL GUARD, & ELIGIBLE DEPENDENTS

The college is an institution of higher learning approved for Veterans, Selected Reservist, National Guard, and eligible dependents educational benefits. A large number of these individuals are currently enrolled and the college encourages students to take advantage of the benefits available. The Office of Veterans Affairs unit is located in the Admissions Office, R-102, (213) 763-5305.

Join Your Associated Students Organization Today!

Buy an ASO membership for only \$7, and enjoy these benefits all semester long!

- ASO picture ID card proving your student status and making you eligible for discounts at movies, plays, museums, dances, activities and athletic events, etc...
- Access to \$100 emergency student loans
- Admittance for you and your guests to a free brunch the day of graduation
- Membership in ASO clubs
- The opportunity to be part of an organized voice for your student government

All this and more for only \$7 per semester! For more information or to sign up, visit the ASO Student Office in C-105.

**2009-2010 GRADUATION PLAN "A" STUDENT PROGRAM ADVISEMENT WORKSHEET
for the Associate in Arts or Associate in Science Degree**

Student's Name: _____
(Please print) Last First Middle SSN (or student ID#)

Units Requirement: 60 to 64 units of course credit in a related curriculum.

Major Requirement: At least 18 semester units of study taken in a single discipline or related disciplines.

Scholarship Requirement: A "C" (2.0) grade average or better in all college work attempted in the curriculum upon which the degree is based.

General Education Requirements: Successful completion of at least 30 semester units of general education as indicated in the areas below.

Students who are interested in transferring to a four-year college or university should visit the University Transfer Center, H-130 or consult with a counselor regarding which courses can transfer.

	Units comp	Units in progress	Units needed	Equiv. courses other CC's		Units comp	Units in progress	Units needed	Equiv. courses other CC's		
A. NATURAL SCIENCES (3 units minimum) Anthropology 101 Astronomy 1, 2, 5 Biology 3, 6, 7, 20, 36 Chemistry 40, 51, 65, 70, 101, 102, 211, 212, 221 Chemical Technology 111, 121 Electronics 2 Environmental Science 1 Geography 1 Geology 1, 6 Microbiology 1, 20 Physical Science 1, 14 Physics 1, 2, 3, 4, 6, 7, 11, 12, 14 ¹ , 29 ¹ , 32 ¹ Psychology 2					D. LANGUAGE & RATIONALITY (12 units minimum) 1. English Composition/English Competency Requirement Completion of one of the following courses (or its equivalent at another college) with a grade of "C" or better English 101 2. Communication & Analytical Thinking Select two courses from the list below. To meet the mathematics competency, complete at least one course listed in Section a below (or its equivalent at another college) must be completed with a grade of "C" or better OR Achievement of a score of 15 or higher on the District Mathematics Competency Examination a. Math 125 **Statistics 1 **Computer Technology 60 **Electronics 10, 12, 14 **General Engineering Technology 121 **Engineering Technology 49, 50, 51 b. Computer Information Systems 701 English 103 Philosophy 6, 8 Speech 101, 103, 104, 151 3. Select an additional course from D1 or D2 above						
B. SOCIAL & BEHAVIORAL SCIENCES (9 units minimum) 1. American Institutions & U.S. History History 11, 12, 13, 41, 42, 43, 44, 52, <i>or</i> Political Science 1 <i>or</i> Labor Studies 4 Students can elect to take a competency exam. The exam is available upon request from the Social Science Department, room F-225, (213) 763-3938 2. Social Sciences (Select one course from the list below) Anthropology 102, 109, 121 Business 1, 5 Child Development 1, 2, 3, 11, 42 Economics 1, 2 Geography 2 History 86, 87 Political Science 2, 7 Psychology 1, 11, 17, 32, 41, 69 Sociology 1, 2, 28 Speech Communication 121, 122, 122H 3. One additional course from B1 <i>or</i> B2 above					E. HEALTH & PHYSICAL EDUCATION (3 units minimum) Select one option 1. Health 2 or 6 (meets both Physical Education & Health requirements) 2. 1 unit of P.E. and choose one from Health 8, 11, 12, 21, 31, 32, 33, 35, 41, 42, 44, 45, 46, 47, 50, 51, <i>or</i> 52 TOTAL						
C. HUMANITIES (3 units minimum) American Sign Language 1, 2 Arabic 1 Architecture 130 ¹ , 131 ¹ Art 101, 102, 103, 104, 201, 202, 300, 501, 502 Chinese 1, 2 English 102, 203, 205, 205H, 206, 206H, 207, 208, 212, 212H, 213, 215, 215H, 218, 219, 220, 220H, 234, 240, 270 French 1, 2, 3, 21 Humanities 1, 2, 54, 60, 61, 73 Japanese 1, 21, 22 Journalism 105 Music 101, 141, 142 Philosophy 1 Physical Education 750, 761, 762, 800 Spanish 1, 2, 3, 4, 21, 22, 35, 36 Speech 130 Theater 100, 210, 507 Visual Communications 106 ¹ , 108 ¹ , 120 ¹ , 130 ¹					Note: Nursing students are exempted from the Health requirement. Persons requiring exemption from physical Education for medical purposes or extenuating circumstances must file a general petition in the Office of Admissions & Records, R-102. Students who take and pass competency examinations are awarded competency credit but no unit credit. ¹ This course alone will not meet the unit requirement to fulfill the category. **These courses are not offered at Trade-Tech but may have been taken at another college in the Los Angeles Community College District						

You must apply for graduation. Forms and instructions are available in the Admissions and Records Office, R-Bldg, Room 102, Graduation windows 9 and 10.

Counselor's Signature _____

Date _____



2009-2010 GRADUATION PLAN "B" STUDENT PROGRAM ADVISEMENT WORKSHEET for the Associate in Arts or Associate in Science Degree

Student's Name: _____
(Please print) Last First Middle SSN (or student ID#)

Units Requirement: 60 to 64 units of course credit in a selected curriculum.

Major Requirement: At least 36 semester units of study taken in a single discipline or related disciplines.

Scholarship Requirement: A "C" (2.0) grade average or better in all college work attempted in the curriculum upon which the degree is based.

General Education Requirements: Successful completion of at least 18 semester units of general education as indicated in the areas below.

Students who are interested in transferring to a four-year college or university should visit the University Transfer Center, H-130, or consult with a counselor regarding which courses can transfer.

GRADUATION & TRANSFER

	Units comp	Units in progress	Units needed	Equiv. courses other CC's		Units comp	Units in progress	Units needed	Equiv. courses other CC's
A. NATURAL SCIENCES (3 units minimum) Anthropology 101 Astronomy 1, 2, 5 Biology 3, 6, 7, 20, 36 Chemistry 40, 51, 65, 70, 101, 102, 211, 212, 221 Chemical Technology 111, 121 Electronics 2 Environmental Science 1 Geography 1 Geology 1, 6 Microbiology 1, 20 Physical Science 1, 14 Physics 1, 2, 3, 4, 6, 7, 11, 12, 14 ¹ , 29 ¹ , 32 ¹ Psychology 2					D. LANGUAGE & RATIONALITY (6 units minimum) 1. English Composition/English Competency Requirement Completion of one of the following courses (or its equivalent at another college) with a grade of "C" or better English 101 2. Communication & Analytical Thinking To meet the mathematics competency, complete at least one course listed in Section a below (or its equivalent at another college) must be completed with a grade of "C" or better OR Achievement of a score of 15 or higher on the District Mathematics Competency Examination a. Math 125 **Statistics 1 **Computer Technology 60 **Electronics 10, 12, 14 **General Engineering Technology 121 **Engineering Technology 49, 50, 51 Select 3 units from the following courses only if competency exam was taken and passed b. Computer Information Systems 701 English 103 Philosophy 6, 8 Speech 101, 103, 104, 151				
B. SOCIAL & BEHAVIORAL SCIENCES (3 units minimum) 1. American Institutions & U.S. History History 11, 12, 13, 41, 42, 43, 44, 52, <u>or</u> Political Science 1 <u>or</u> Labor Studies 4 Students can elect to take a competency exam. The exam is available upon request from the Social Science Dept., room F-225, (213) 763-3938 2. Social Sciences Select 3 units from the following courses <u>only if</u> competency exam was taken and passed Anthropology 102, 109, 121 Business 1, 5 Child Development 1, 2, 3, 11, 42 Economics 1, 2 Geography 2 History 86, 87 Political Science 2, 7 Psychology 1, 11, 17, 32, 41, 69 Sociology 1, 2, 28 Speech Communications 121, 122, 122H					E. HEALTH & PHYSICAL EDUCATION (3 units minimum) Select one option 1. Health 2 or 6 (meets both Physical Education & Health requirements) 2. 1 unit of P.E. and choose one from Health 8, 11, 12, 21, 31, 32, 33, 35, 41, 42, 44, 45, 46, 47, 50, 51, or 52 TOTAL				
C. HUMANITIES (3 units minimum) American Sign Language 1, 2 Arabic 1 Architecture 130 ¹ , 131 ¹ Art 101, 102, 103, 104, 201, 202, 300, 501, 502 Chinese 1, 2 English 102, 203, 205, 205H, 206, 206H, 207, 208, 212, 212H, 213, 215, 218, 219, 220, 220H, 234, 240, 270 French 1, 2, 3, 21 Humanities 1, 2, 54, 60, 61, 73 Japanese 1, 21, 22 Journalism 105 Music 101, 141, 142 Philosophy 1 Physical Education 750, 761, 762, 800 Spanish 1, 2, 3, 4, 21, 22, 35, 36 Speech 130 Theater 100, 210, 507 Visual Communications 106 ¹ , 108 ¹ , 120 ¹ , 130 ¹					Note: Nursing students are exempted from the Health requirement. Persons requiring exemption from physical Education for medical purposes or extenuating circumstances must file a general petition in the Office of Admissions & Records, R-102. Students who take and pass competency examinations are awarded competency credit but no unit credit. ¹ This course alone will not meet the unit requirement to fulfill the category. **These courses are not offered at Trade-Tech but may have been taken at another college in the Los Angeles Community College District				

You must apply for graduation. Forms and instructions are available in the Admissions and Records Office, R-Bldg, Room 102, Graduation windows 9 and 10.

Counselor's Signature

Date

2009-2010 UC/CSU – IGETC GENERAL EDUCATION CHECK SHEET

Student's Name: _____
 (Please print) Last First Middle SSN (or student ID#)

The Intersegmental General Education Transfer Curriculum (IGETC) is a series of courses that community college students can use to satisfy lower division general education requirements at any CSU or UC campus. The IGETC provides an option to the California State University General Education Requirements. Students in high unit majors are encouraged to follow a particular UC campus' breadth requirements instead of the IGETC. See a counselor for additional information. **IMPORTANT:** The IGETC must be certified prior to transfer! If not certified, a student will be required to complete the four-year university's own general education/breadth requirements and additional lower-division coursework may be required. All courses must be completed with "C" grade or higher. (See your counselor for certification)

GRADUATION & TRANSFER

LEGEND: C = Completed IP = In Progress or AP Exam	EC = Equivalent Course R = Remaining	Units comp	Units in progress	Units needed	Equiv. courses other CC's	LEGEND: C = Completed IP = In Progress or AP Exam	EC = Equivalent Course R = Remaining	Units comp	Units in progress	Units needed	Equiv. courses other CC's
AREA 1 - ENGLISH COMMUNICATION CSU - 3 courses required, one from each group below, 9 semester units UC - 2 courses required, one each from Group A and B, 6 semester units Group A: English Composition (1 course, 3 semester units) English 101, 101H Group B: Critical Thinking - English Composition (1 course, 3 semester units) English 103 Group C: Oral Communication (CSU only) (1 course, 3 semester units) Speech 101, 104, 151						AREA 4 - SOCIAL AND BEHAVIORAL SCIENCES (at least 3 courses, 9 semester units) At least three from two disciplines or an interdisciplinary sequence. Anthropology 102, 109, 121 Child Development 1 Economics 1, 2 Geography 2 History 11*, 12*, 13*, 41*, 42*, 43*, 44, 52**, 86, 87 Labor Studies 8 Political Science 1**, 2, 7 Psychology 1, 11, 32 Sociology 1, 2 Speech 122, 122H					
AREA 2 - MATHEMATICAL CONCEPTS AND QUANTITATIVE REASONING (1 course, 3 semester units) Math 225, 227, 235*, 236*, 245, 260, 265*, 266*, 267, 270, 275						AREA 5 - PHYSICAL AND BIOLOGICAL SCIENCES (at least 2 course, 7-9 semester units) One Physical Science course and one Biological Science course; at least one must include a laboratory (indicated by "L" in parentheses). PHYSICAL SCIENCES Astronomy 1*, 2*(L) or 5 (L) Chemistry 51*(L), 65*(L), 70*(L), 101(L), 102(L), 211(L), 212(L), 221(L) Geography 1 Geology 1 Physics 1*(L), 2*(L), 3*(L), 4*(L), 6*(L), 7*(L), 11*(L), 12*, 14*(L)					
AREA 3 - ART AND HUMANITIES (at least 3 courses, 9 semester units) At least one course from Arts, one from Humanities, and a third course from Arts or Humanities Arts Courses: Art 101, 102 103, 104 Music 101, 142 Physical Education 800 Theater 100, 507 Humanities Courses: American Sign Language 2 Humanities 1, 2*, 60 English 102, 203, 205, 205H, 206, 206H, 207, 208, 212, 212H, 213, 215, 215H, 219, 220, 220H, 234, 240, 270 French 2, 3 History 52** Japanese 2 Philosophy 1 Spanish 2, 3, 4 Theater 100**, 507**						BIOLOGICAL SCIENCES Anthropology 101 Biology 3*(L), 6(L), 7(L), 20(L) Microbiology 1*(L), 20*(L)					
*Indicates that transfer credit may be limited by either UC or CSU or both. Please consult with a counselor for additional information. **Course may be listed in more than one area, but shall not be certified in more than one area.						FOREIGN LANGUAGE (UC requirement only) Proficiency equivalent to two years of high school study in the same language. American Sign Language 1, 2** Arabic 1 Chinese 1, 2 French 1, 2**, 3** Japanese 1, 2**, 22 Spanish 1, 2**, 3**, 4**, 21, 22, 35, 36 Completed at high school					
						TOTAL					

CSU GRADUATION REQUIREMENT IN AMERICAN INSTITUTIONS 6 units, one course from (a) and one course from (b) (a) Political Science 1 (b) History 11, 12, 13					
Note: Courses used to meet this requirement may not be used to satisfy requirements for IGETC					

Certification of these units is not automatic and must be requested. First, see a counselor to have records evaluated for certification. Coursework from other colleges or universities must be on file (official transcript) in the Admission Office.

Counselor (Print Name) _____ Signature _____ Date _____
 Evaluation Technician (Print Name) _____ Signature _____ Date _____

EDUCATIONAL PROGRAMS

Los Angeles Trade-Technical College has approval from the District Board of Trustees and the State Chancellor's Office to offer the following occupational programs and to grant the degrees and/or certificates as indicated.

Major Code		Degree	Certificate	Major Code		Degree	Certificate
0201.00	Architectural Technology	•	•	0934.23	• Programmable Logic Controllers		
0201.02	• Computer Aided Drafting			0934.21	• Voice Data Video and Fire Life Safety Technician		
0299.00	• Digital Design			0952.22	• Motor Control		
0299.01	• Historic Preservation			0934.01	Electronics Communication	•	•
2206.11	• Community GIS Mapping			0934.17	• Advanced Electronics Assembly and Repair		
0299.00	• M.A.P.S/G.I.S		•	0934.25	• Basic Electronics Assembly and Repair		
0948.20	Automotive Collision Repair	•	•	0934.18	• Digital Circuits Technician		
0948.00	Automotive And Related Technology	•	•	0934.31	• Electronics Communications Technician		
0948.00	• Engine Performance			0999.02	• Robotics		
0948.01	• Transmission Repair			0934.27	• Semiconductor Devices Technician		
0948.02	• Mechanical Repair			0934.35	• Telecommunication Field Technician		
0948.04	• Brake Suspension and Steering Technology			0709.05	• IT Security Specialist - Level I		
1306.32	Baking, Professional	•	•	0708.11	• CIS/Linux Networking Certificate		
	Business			0934.81	• Fiber Optics Network Cabling Specialist		
0502.00	• Accounting	•	•	0999.01	• Soldering Surface Mount Technology		
0502.01	• Accounting Clerk		•	1501.00	English	•	
0502.05	• Accounting Clerk Assistant		•	1303.10	Fashion Design	•	•
1499.01	• Bilingual Law Assistant			1303.33	• Apparel Computer Technology		
0509.51	• Customer Service Specialist			1303.11	• Fashion Technology	•	
0506.31	• Governmental Supervision		•	1303.10	Fashion Design-Adjunct		•
0502.12	• Income Tax Preparation Specialist			1303.20	Fashion Merchandising	•	•
0506.01	• Management/Supervision	•	•	1303.22	• Fashion Promotion		
0509.50	• Marketing and Public Relations	•	•	1303.21	• Retail Fashion Management		
0502.04	• Payroll Specialist			0516.00	Labor Studies	•	•
0506.03	• Project Management Specialist			4901.00	Liberal Arts	•	
0511.00	• Real Estate	•	•	0956.31	Machine Shop CNC	•	•
0509.51	• Retail Merchandising	•		0956.32	Machine Shop CNC - Adjunct	•	•
0509.52	• Sales and Marketing Specialist			0934.02	Microcomputer Technician I.T. Essentials	•	•
0709.01	• Website Development & Maintenance Assistant/Small Bus			0708.18	• A + Microcomputer Technician		
0506.02	• Small Business Entrepreneurship		•	0504.00	Mortgage Finance – Plan A	•	
0952.50	Cabinetmaking and Millwork	•	•	0504.00	Mortgage Finance – Plan B	•	•
0951.51	Construction Technologies	•	•	0504.04	• Mortgage Loan Officer		
0952.10	Carpentry	•	•	0504.03	• Financial/Home Ownership Counselor		
0952.11	Carpentry: Construction Technologies	•	•	0504.01	• Bank Teller		
0955.00	Chemical Technology	•	•	0948.31	Motorcycle Repair Mechanics		•
0954.01	• Process Plant Technology			0945.13	Operation and Maintenance Engineering		•
0958.01	• Solid Waste Management Technology		•	1203.00	Nursing, Registered	•	
1305.10	Child Development - Plan A	•		1302.20	Nursing, Vocational	•	•
1305.11	Child Development - Plan B	•		1230.35	• Certified Nurse Assistant (C.N.A.)		
1305.15	• Center Director			1230.81	• Home Health Aide (HHA)		
1305.16	• Infant Care Teacher				Physical Education		
1305.12	• Preschool Teacher		•	0835.71	• Aquatics		
1305.14	• Preschool Teacher Assistant			0835.61	• Coaching		
1305.17	• School Age Programs Teacher/Daycare			1305.52	• Elementary Movement Education/Playground		
2102.01	Community Planning and Economic Development	•	•	0835.81	• Fitness for Special Population		
0506.01	• Nonprofit Executive Management			0835.10	• Dance, Beginning		
2102.03	• Community Safety Specialist			0835.11	• Dance, Advanced		
0511.03	• Urban Real Estate Development			0952.30	Plumbing	•	•
2102.01	• Neighborhood Emergency Preparedness Specialist			0952.31	Plumbing: Construction Technologies	•	•
0511.01	• Apartment Management			0958.00	Process Technology	•	•
	Computer Applications and Office Technologies			0945.11	Refrigeration and Air Conditioning Mechanics-AA	•	•
0514.00	• Administrative Assistant	•	•	0945.10	Refrigeration and Air Conditioning Mechanics-AS	•	•
0514.03	• General Office Assistant			0946.11	• Fundamentals of Refrigeration & Air Conditioning		
0514.02	• Information Processing Specialist	•	•	1306.11	Restaurant Management	•	•
1402.03	• Legal Office Assistant			1013.01	Sign Graphics	•	•
0514.21	• Medical Office Assistant	•	•	0999.01	Street Maintenance Technology	•	•
0514.01	• Office Assistant-Clerical	•	•	1303.32	Tailoring-Adjunct	•	•
0701.00	Computer Information Systems	•	•	1013.00	Visual Communications	•	•
3007.00	Cosmetology	•	•	0958.00	Water Systems Technology	•	
1306.30	Culinary Arts	•	•	0958.02	• Supply Water Technology		•
1306.30	• Baking, Professional	•	•	0958.03	• Wastewater Technology		•
1306.31	• Restaurant & Food Services Management	•	•	0958.40	• Solid Waste Management Technology		•
0947.00	Diesel and Related Technology	•	•	0956.51	Welding Gas and Electric	•	•
0952.24	Electrical Construction and Maintenance	•	•	0956.51	Welding Gas and Electric: Construction Technologies	•	•
0935.01	• Basic Electrician Trainee			1002.21	• Metal Sculpture		
0935.01	• National Electrical Code						

EDUCATIONAL PROGRAMS

SPRING 2010 SCHEDULE OF CLASSES

How to read the schedule of classes:

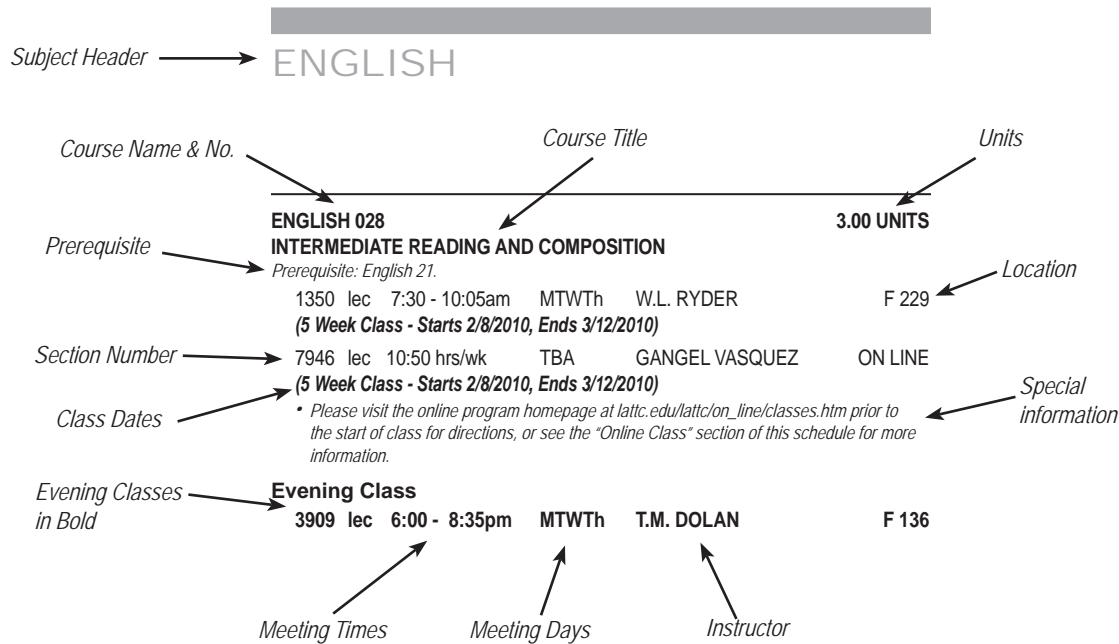

Notes:

1. Bold face type denotes Evening Classes
2. Building and Room Number (If an address is given instead of a regular building and room number, the class is an off-campus class meeting at the address shown.)
3. TBA - To Be Arranged
4. "RPT" followed by a number shows the number of times that a class may be repeated for credit.
5. HRS - Hours per week
6. Lab - Laboratory
7. Lec - Lecture

Course Descriptions:

1. UC - this course is acceptable for unit credit at all branches of the University of California.
2. CSU - this course is acceptable for credit at all branches of the California State universities and colleges.
3. NDA - (Non Degree Applicable) - this course is offered for college credit but cannot be applied toward graduation requirements for the associate degree.



Notice of Room Changes

Trade-Tech will be undergoing construction throughout the 2009-10 school year and classroom locations are subject to change after the printing of this schedule. Please check the college website for updates on individual class locations by logging onto the LATTC.edu website, then going to "Schedule of Classes" and following the individual links. Thank you for your patience during this process.

ACCOUNTING

ACCOUNTING 001 INTRODUCTORY ACCOUNTING I (UC:CSU) 5.00 UNITS

Recommended Preparation: Business 38.

0101	lec	8:35am - 9:50am	MTWTh	STAFF	K 324
Evening Class					
3001	lec	6:00pm - 8:35pm	MW	R.L. GONZALEZ	K 324
3004	lec	5:30pm - 8:30pm	T	C.R. MONTOUR	K 208
&	lec	2:30 hrs/wk	TBA	C.R. MONTOUR	K 208

ACCOUNTING 002 INTRODUCTORY ACCOUNTING II (UC:CSU) 5.00 UNITS

3008	lec	1:00pm - 6:10pm	S	R.A. JOHNSON	K 302
------	-----	-----------------	---	--------------	-------

ACCOUNTING 011 COST ACCOUNTING (CSU) 3.00 UNITS

Evening Class

3009	lec	6:00pm - 9:10pm	W	C.R. MONTOUR	K 301
------	-----	-----------------	---	--------------	-------

ACCOUNTING 022 BOOKKEEPING AND ACCOUNTING II (UC:CSU) 3.00 UNITS

0102	lec	8:35am - 9:50am	MTWTh	STAFF	K 324
------	-----	-----------------	-------	-------	-------

ACCOUNTING 025 AUTOMATED ACCOUNTING METHODS AND PROCEDURES (CSU) 3.00 UNITS

Evening Class

3013	lec	5:00pm - 8:10pm	M	C.R. MONTOUR	K 208
------	-----	-----------------	---	--------------	-------

ADMINISTRATION OF JUSTICE

ADMINISTRATION OF JUSTICE 014 REPORT WRITING FOR PEACE OFFICERS (CSU) 3.00 UNITS

7878	lec	3:15 hrs/wk	TBA	W.D. ELARTON	ON LINE
> Please visit the online program homepage at http://moodle.lattc.edu prior to the start of class for directions, or see pages 70-72 of this schedule for more information.					

ADMINISTRATION OF JUSTICE 051 AN A TO Z GUIDE TO CRIMINAL JUSTICE CAREERS (CSU) 3.00 UNITS

6810	lec	8:00am - 11:10am	S	D. JACKSON	HPK HS
> 6020 Miles Ave., Los Angeles, CA 90255					

AMERICAN SIGN LANGUAGE

AMERICAN SIGN LANGUAGE 001 AMERICAN SIGN LANGUAGE I (UC:CSU) 4.00 UNITS

0760	lec	8:00am - 10:05am	MW	A.C. NATALE	E 214
0761	lec	8:00am - 10:05am	TTh	J.H. WONG	E 216

AMERICAN SIGN LANGUAGE 002 AMERICAN SIGN LANGUAGE II (UC:CSU) 4.00 UNITS

Prerequisite: American Sign Language I.

0762	lec	8:00am - 10:05am	MW	S. CORNEAL	E 216
------	-----	------------------	----	------------	-------

ANTHROPOLOGY

ANTHROPOLOGY 101 HUMAN BIOLOGICAL EVOLUTION (UC:CSU) 3.00 UNITS

1000	lec	8:35am - 10:00am	MW	P.J. HULD	F 214
1001	lec	10:10am - 11:35am	MW	P.J. HULD	F 214
1003	lec	11:45am - 1:10pm	TTh	P.J. HULD	F 214
1171	lec	8:35am - 10:00am	MW	P.J. HULD	F 214
7971	lec	3:15 hrs/wk	TBA	P.J. HULD	ON LINE
> Please visit the online program homepage at http://moodle.lattc.edu prior to the start of class for directions, or see pages 70-72 of this schedule for more information.					

Evening Class

3606 lec 6:00pm - 9:10pm M M.J. CARTER F 215

ANTHROPOLOGY 102 HUMAN WAYS OF LIFE: CULTURAL ANTHROPOLOGY (UC:CSU) 3.00 UNITS

1005	lec	8:35am - 10:00am	TTh	P.J. HULD	F 214
1006	lec	11:45am - 1:10pm	MW	P.J. HULD	F 214
1072	lec	8:35am - 10:00am	TTh	P.J. HULD	F 214

ARCHITECTURE

ARCHITECTURE 130 HISTORY OF ARCHITECTURE I (UC:CSU) 2.00 UNITS

8021	lec	7:00am - 9:05am	F	STAFF	D 325
------	-----	-----------------	---	-------	-------

ARCHITECTURE 152 EQUIPMENT OF BUILDINGS (CSU) 3.00 UNITS

8041	lec	7:00am - 8:05am	TTh	M. OLIVA	D 303
&	lab	8:05am - 9:35am	TTh	M. OLIVA	D 303

ARCHITECTURE 202 ARCHITECTURAL DESIGN II (UC:CSU) 3.00 UNITS

8034	lec	9:45am - 10:50am	MW	M. OLIVA	D 330
&	lab	10:50am - 12:20pm	MW	M. OLIVA	D 330

ARCHITECTURE 272 ARCHITECTURAL DRAWING IV (CSU) 3.00 UNITS

8040	lec	7:00am - 8:05am	MW	M. OLIVA	D 303
&	lab	8:05am - 9:35am	MW	M. OLIVA	D 303

ART

ART 101 SURVEY OF ART HISTORY I (UC:CSU) 3.00 UNITS

Western art from prehistoric times through the Renaissance.

1340	lec	7:00am - 8:25am	MW	P.J. HERBERT	H 224
1341	lec	10:10am - 11:35am	MW	P.J. HERBERT	H 224
1342	lec	11:45am - 1:10pm	MW	P.J. HERBERT	H 224
1584	lec	7:00am - 8:25am	MW	P.J. HERBERT	H 224
7939	lec	5:30 hrs/wk	TBA	A. MALONE	ON LINE

(10 Week Class - Starts 4/5/2010, Ends 6/7/2010)
 > Please visit the online program homepage at <http://moodle.lattc.edu> prior to the start of class for directions, or see pages 70-72 of this schedule for more information.

7940	lec	3:15 hrs/wk	TBA	G.J. SZYMANSKI	ON LINE
------	-----	-------------	-----	----------------	---------

> Please visit the online program homepage at <http://moodle.lattc.edu> prior to the start of class for directions, or see pages 70-72 of this schedule for more information.

Evening Class

3824 lec 6:00pm - 8:50pm W C.D. PARKER F 214

ART 102 3.00 UNITS
SURVEY OF ART HISTORY II (UC:CSU)

Western art from early Renaissance to the present.

1343 lec 8:35am - 10:00am MW P.J. HERBERT H 224

Evening Class

3831 lec 6:00pm - 9:05pm Th C.D. PARKER F 229

ART 103 3.00 UNITS
ART APPRECIATION I (UC:CSU)

1345 lec 10:10am - 11:35am TTh G.J. SZYMANSKI H 236

ART 104 3.00 UNITS
ART APPRECIATION II (UC:CSU)

7944 lec 3:15 hrs/wk TBA A. MALONE ON LINE

➤ Please visit the online program homepage at <http://moodle.lattc.edu> prior to the start of class for directions, or see pages 70-72 of this schedule for more information.**ART 185** 1.00 UNIT
DIRECTED STUDY - ART HONORS (CSU)

1351 lec 1:05 hrs/wk TBA P.J. HERBERT H 224

1352 lec 1:05 hrs/wk TBA G.J. SZYMANSKI H 236

ART 201 3.00 UNITS
DRAWING I (UC:CSU)

Pencil, charcoals, pastel and other drawing media.

1347 lec 8:00am - 9:05am TTh P.J. HERBERT H 224

& lab 9:05am - 10:10am TTh P.J. HERBERT H 224

1348 lec 12:30pm - 1:35pm MW G.J. SZYMANSKI H 236

& lab 1:35pm - 2:35pm MW G.J. SZYMANSKI H 236

1358 lec 10:10am - 11:15am MW G.J. SZYMANSKI H 236

& lab 11:15am - 12:20pm MW G.J. SZYMANSKI H 236

1366 lab 8:00am - 12:10pm S F.J. WILLIAMS H 236

Evening Class

3826 lec 6:00pm - 8:05pm T A. MANN H 236

& lab 8:05pm - 10:10pm T A. MANN H 236

ART 202 3.00 UNITS
DRAWING II (UC:CSU)

Continuation of Art 201.

1349 lec 8:00am - 9:05am TTh P.J. HERBERT H 224

& lab 9:05am - 10:05am TTh P.J. HERBERT H 224

1350 lec 12:30pm - 1:35pm MW G.J. SZYMANSKI H 236

& lab 1:35pm - 2:35pm MW G.J. SZYMANSKI H 236

1365 lec 10:10am - 11:15am MW G.J. SZYMANSKI H 236

& lab 11:15am - 12:20pm MW G.J. SZYMANSKI H 236

1367 lec 8:00am - 12:15pm S F.J. WILLIAMS H 236

Evening Class

3828 lec 6:00pm - 8:05pm T A. MANN H 236

& lab 8:05pm - 10:10pm T A. MANN H 236

ART 285 2.00 UNITS
DIRECTED STUDY - ART HONORS (CSU)

1353 lec 2:05 hrs/wk TBA P.J. HERBERT H 224

1354 lec 2:05 hrs/wk TBA G.J. SZYMANSKI H 236

Evening Class

3829 lec 2:05 hrs/wk TBA G.J. SZYMANSKI H 236

ART 300 3.00 UNITS
INTRODUCTION TO PAINTING (UC:CSU)

Applications of acrylic, oil, and watercolor.

1357 lec 10:10am - 11:15am TTh P.J. HERBERT H 224

& lab 11:15am - 12:15pm TTh P.J. HERBERT H 224

ART 304 3.00 UNITS
ACRYLIC PAINTING I (CSU)

1364 lec 10:10am - 11:15am TTh P.J. HERBERT H 224

& lab 11:15am - 12:20pm TTh P.J. HERBERT H 224

ART 385 3.00 UNITS
DIRECTED STUDY - ART HONORS (CSU)

1355 lec 3:15 hrs/wk TBA P.J. HERBERT H 224

1356 lec 3:15 hrs/wk TBA G.J. SZYMANSKI H 236

ART 501 3.00 UNITS
BEGINNING TWO-DIMENSIONAL DESIGN (UC:CSU)

1359 lec 12:20pm - 1:25pm TTh G.J. SZYMANSKI H 236

& lab 1:25pm - 2:25pm TTh G.J. SZYMANSKI H 236

ART 502 3.00 UNITS
BEGINNING THREE-DIMENSIONAL DESIGN (UC:CSU)

1360 lec 12:20pm - 1:25pm TTh G.J. SZYMANSKI H 236

& lab 1:25pm - 2:25pm TTh G.J. SZYMANSKI H 236

ASTRONOMY**ASTRONOMY 001** 3.00 UNITS
ELEMENTARY ASTRONOMY (UC:CSU)

1600 lec 7:00am - 8:25am MW F.J. PADILLA K 406

1601 lec 1:20pm - 2:45pm MW M.A. MORENO K 321

1602 lec 10:10am - 11:35am TTh F.J. PADILLA K 406

Evening Class

4045 lec 5:00pm - 6:25pm TTh M.A. MORENO USC EART

➤ First class meeting will be at LATTC, Room K-420. USC - University Park Campus Earth Science, Building B-56. Contact 213-763-7295

ASTRONOMY 005 1.00 UNIT
FUNDAMENTALS OF ASTRONOMY LABORATORY (UC:CSU)

1603 lab 7:00am - 10:10am T F.J. PADILLA K 422

Evening Class

4046 lab 7:00pm - 8:25pm TTh M.A. MORENO USC EART

➤ First class meeting will be at LATTC, Room K-420. USC - University Park Campus Earth Science, Building B-56. Contact 213-763-7295

AUTOMOTIVE AND RELATED TECHNOLOGY**AUTOMOTIVE AND RELATED TECHNOLOGY 100** 3.00 UNITS
HEATING AND AIR CONDITIONING SYSTEMS THEORY, INSPECTION & RPR**Evening Class**

4382 lec 5:35pm - 6:30pm TTh B.A. GOYN F 128

& lab 6:30pm - 9:30pm TTh B.A. GOYN F 128

AUTOMOTIVE AND RELATED TECHNOLOGY 112 3.00 UNITS
BASIC SHOP PRINCIPLES AND PRACTICES

7490 lec 7:00am - 7:45am MTWThF D.A. ENCINAS F 124

& lab 7:45am - 12:00pm MTWThF D.A. ENCINAS F 124

(6 Week Class - Starts 2/8/2010, Ends 3/17/2010)

7491 lec 7:00am - 7:45am MTWThF D.A. ENCINAS F 124

& lab 7:45am - 12:00pm MTWThF D.A. ENCINAS F 124

*(6 Week Class - Starts 3/18/2010, Ends 4/28/2010)***AUTOMOTIVE AND RELATED TECHNOLOGY 113A** 3.00 UNITS
AUTOMATIC TRANSMISSION/TRANSAXLE THEORY, INSPECTION, REPAIR

7346 lec 7:00am - 7:45am MTWThF J.R. URIBE F 130

& lab 7:45am - 12:00pm MTWThF J.R. URIBE F 130

*(6 Week Class - Starts 3/18/2010, Ends 4/28/2010)***Evening Class**

4381 lec 5:35pm - 6:30pm MW R. GUERRA F 132

& lab 6:30pm - 9:30pm MW R. GUERRA F 132

AUTOMOTIVE AND RELATED TECHNOLOGY 113B 3.00 UNITS
MANUAL DRIVE TRAIN AXLES THEORY, INSPECTION, AND REPAIR

7352 lec 7:00am - 7:45am MTWThF D.A. ENCINAS F 130

& lab 7:45am - 12:00pm MTWThF D.A. ENCINAS F 130

(6 Week Class - Starts 4/29/2010, Ends 6/7/2010)

AUTOMOTIVE AND RELATED TECHNOLOGY 114A						3.00 UNITS
SUSPENSION AND STEERING THEORY, INSPECTION AND REPAIR						
7341	lec	7:00am - 7:45am	MTWThF	J.R. URIBE	F 108	
&	lab	7:45am - 12:00pm	MTWThF	J.R. URIBE	F 108	
<i>(6 Week Class - Starts 2/8/2010, Ends 3/17/2010)</i>						
Evening Class						
4380	lec	5:35pm - 6:30pm	MW	J.R. URIBE	F 108	
&	lab	6:30pm - 9:30pm	MW	J.R. URIBE	F 108	

AUTOMOTIVE AND RELATED TECHNOLOGY 114B						3.00 UNITS
BRAKE SYSTEMS THEORY, INSPECTION AND REPAIR						
7347	lec	7:00am - 7:45am	MTWThF	J.R. URIBE	F 108	
&	lab	7:45am - 12:00pm	MTWThF	J.R. URIBE	F 108	
<i>(6 Week Class - Starts 4/29/2010, Ends 6/7/2010)</i>						

AUTOMOTIVE AND RELATED TECHNOLOGY 121						3.00 UNITS
BASIC ENGINE THEORY INSPECTION AND REPAIR (CSU)						
7342	lec	7:00am - 7:45am	MTWThF	T.J. MCFALL	F 122	
&	lab	7:45am - 12:00pm	MTWThF	T.J. MCFALL	F 122	
<i>(6 Week Class - Starts 2/8/2010, Ends 3/17/2010)</i>						
7345	lec	7:00am - 7:45am	MTWThF	T.J. MCFALL	F 122	
&	lab	7:45am - 12:00pm	MTWThF	T.J. MCFALL	F 122	
<i>(6 Week Class - Starts 3/18/2010, Ends 4/28/2010)</i>						
7354	lec	7:00am - 7:45am	MTWThF	T.J. MCFALL	F 122	
&	lab	7:45am - 12:00pm	MTWThF	T.J. MCFALL	F 122	
<i>(6 Week Class - Starts 4/29/2010, Ends 6/7/2010)</i>						
Evening Class						
4400	lec	5:35pm - 6:30pm	TTh	R.C. SERRATO	F 132	
&	lab	6:30pm - 9:30pm	TTh	R.C. SERRATO	F 106	

AUTOMOTIVE AND RELATED TECHNOLOGY 122						3.00 UNITS
ELECTRICAL/ELECTRONIC SYSTEMS THEORY, INSPECTION & REPAIR (CSU)						
7343	lec	7:00am - 7:45am	MTWThF	W.F. WOO	F 128	
&	lab	7:45am - 12:00pm	MTWThF	W.F. WOO	F 128	
<i>(6 Week Class - Starts 2/8/2010, Ends 3/17/2010)</i>						
7349	lec	7:00am - 7:45am	MTWThF	W.F. WOO	F 128	
&	lab	7:45am - 12:00pm	MTWThF	W.F. WOO	F 128	
<i>(6 Week Class - Starts 3/18/2010, Ends 4/28/2010)</i>						
Evening Class						
4384	lec	5:35pm - 6:30pm	MW	W.F. WOO	F 128	
&	lab	6:30pm - 9:30pm	MW	W.F. WOO	F 128	

AUTOMOTIVE AND RELATED TECHNOLOGY 123						3.00 UNITS
FUEL & EMISSIONS SYSTEMS THEORY, INSPECTION & REPAIR (CSU)						
7344	lec	7:00am - 7:45am	MTWThF	M.A. MARROQUIN	F 116	
&	lab	7:45am - 12:00pm	MTWThF	M.A. MARROQUIN	F 116	
<i>(6 Week Class - Starts 2/8/2010, Ends 3/17/2010)</i>						
7350	lec	7:00am - 7:45am	MTWThF	M.A. MARROQUIN	F 116	
&	lab	7:45am - 12:00pm	MTWThF	M.A. MARROQUIN	F 116	
<i>(6 Week Class - Starts 3/18/2010, Ends 4/28/2010)</i>						
7356	lec	7:00am - 7:45am	MTWThF	M.A. MARROQUIN	F 116	
&	lab	7:45am - 12:00pm	MTWThF	M.A. MARROQUIN	F 116	
<i>(6 Week Class - Starts 4/29/2010, Ends 6/7/2010)</i>						

AUTOMOTIVE AND RELATED TECHNOLOGY 130						3.00 UNITS
AUTOMOTIVE THEORY AND REPAIR I (CSU)						
Advanced course on engines and transmissions.						
7358	lec	7:00am - 7:45am	MTWThF	R.C. SERRATO	F 132	
&	lab	7:45am - 12:00pm	MTWThF	G.B. SPEAR	F 106	
<i>(6 Week Class - Starts 2/8/2010, Ends 3/17/2010)</i>						

AUTOMOTIVE AND RELATED TECHNOLOGY 131						3.00 UNITS
AUTOMOTIVE THEORY AND REPAIR II						
Advanced course on emission controls and fuel systems.						
7360	lec	7:00am - 7:45am	MTWThF	R.C. SERRATO	F 132	
&	lab	7:45am - 12:00pm	MTWThF	G.B. SPEAR	F 106	
<i>(6 Week Class - Starts 3/18/2010, Ends 4/28/2010)</i>						

AUTOMOTIVE AND RELATED TECHNOLOGY 132						3.00 UNITS
AUTOMOTIVE THEORY AND REPAIR III (CSU)						
Service and repair of electrical and electronic systems.						
7362	lec	7:00am - 7:45am	MTWThF	R.C. SERRATO	F 132	
&	lab	7:45am - 12:00pm	MTWThF	G.B. SPEAR	F 106	
<i>(6 Week Class - Starts 4/29/2010, Ends 6/7/2010)</i>						

AUTOMOTIVE AND RELATED TECHNOLOGY 135						3.00 UNITS
COMPUTER CONTROL AND FUEL INJECTION (CSU)						
7355	lec	7:00am - 7:45am	MTWThF	W.F. WOO	F 128	
&	lab	7:45am - 12:00pm	MTWThF	W.F. WOO	F 118	
<i>(6 Week Class - Starts 4/29/2010, Ends 6/7/2010)</i>						

AUTOMOTIVE AND RELATED TECHNOLOGY 140						3.00 UNITS
AUTOMOTIVE THEORY AND REPAIR IV (CSU)						
7364	lec	7:00am - 7:45am	MTWThF	G.B. SPEAR	F 118	
&	lab	7:45am - 12:00pm	MTWThF	G.B. SPEAR	F 104	
<i>(6 Week Class - Starts 2/8/2010, Ends 3/17/2010)</i>						

AUTOMOTIVE AND RELATED TECHNOLOGY 141						3.00 UNITS
AUTOMOTIVE THEORY AND REPAIR V (CSU)						
7365	lec	7:00am - 7:45am	MTWThF	G.B. SPEAR	F 118	
&	lab	7:45am - 12:00pm	MTWThF	G.B. SPEAR	F 104	
<i>(6 Week Class - Starts 3/18/2010, Ends 4/28/2010)</i>						

AUTOMOTIVE AND RELATED TECHNOLOGY 142						3.00 UNITS
AUTOMOTIVE THEORY AND REPAIR VI (CSU)						
7366	lec	7:00am - 7:45am	MTWThF	G.B. SPEAR	F 118	
&	lab	7:45am - 12:00pm	MTWThF	G.B. SPEAR	F 104	
<i>(6 Week Class - Starts 4/29/2010, Ends 6/7/2010)</i>						

AUTOMOTIVE AND RELATED TECHNOLOGY 185						1.00 UNIT
DIRECTED STUDY - AUTOMOTIVE AND RELATED TECHNOLOGY						
6870	lec	0:55 hrs/wk	TBA	R.C. SERRATO	CMP GONZ	
➤ Camp Gonzalez, 1301 N. Los Virgenes Road, Calabasas, CA 91302						
7367	lec	3:20 hrs/wk	TBA	R.C. SERRATO	F 108K	
<i>(6 Week Class - Starts 2/8/2010, Ends 3/17/2010)</i>						
7370	lec	3:00 hrs/wk	TBA	R.C. SERRATO	F 108K	
<i>(6 Week Class - Starts 3/18/2010, Ends 4/28/2010)</i>						
7387	lec	3:00 hrs/wk	TBA	R.C. SERRATO	F 108K	
<i>(6 Week Class - Starts 4/29/2010, Ends 6/7/2010)</i>						

AUTOMOTIVE AND RELATED TECHNOLOGY 285						2.00 UNITS
DIRECTED STUDY - AUTOMOTIVE AND RELATED TECHNOLOGY						
7368	lec	7:05 hrs/wk	TBA	R.C. SERRATO	F 108K	
<i>(6 Week Class - Starts 2/8/2010, Ends 3/17/2010)</i>						
7371	lec	6:00 hrs/wk	TBA	R.C. SERRATO	F 108K	
<i>(6 Week Class - Starts 3/18/2010, Ends 4/28/2010)</i>						
7374	lec	6:00 hrs/wk	TBA	R.C. SERRATO	F 108	
<i>(6 Week Class - Starts 4/29/2010, Ends 6/7/2010)</i>						

Become a Certified Automotive Technician!

Did you know Trade-Tech offers a number of degrees and certificates in the fast-growing field of automotive technology? Hands-on courses are taught by automotive professionals in areas such as:

- » Transmission Repair
- » Motorcycle Repair
- » Mechanics
- » Brake Suspension and Steering
- » Transmission Repair
- » Engine Performance Technology



AUTOMOTIVE AND RELATED TECHNOLOGY 385 3.00 UNITS					
DIRECTED STUDY - AUTOMOTIVE AND RELATED TECHNOLOGY					
7369	lec	10:30 hrs/wk	TBA	R.C. SERRATO	F 108K
<i>(6 Week Class - Starts 2/8/2010, Ends 3/17/2010)</i>					
7372	lec	9:00 hrs/wk	TBA	R.C. SERRATO	F 108K
<i>(6 Week Class - Starts 3/18/2010, Ends 4/28/2010)</i>					
7373	lec	3:35 hrs/wk	TBA	R.C. SERRATO	F 108K
<i>(6 Week Class - Starts 4/29/2010, Ends 6/7/2010)</i>					

AUTOMOTIVE AND RELATED TECHNOLOGY 941 4.00 UNITS					
COOPERATIVE EDUCATION - AUTOMOTIVE AND RELATED TECHNOLOGY					
9024	lec	4:25 hrs/wk	TBA	STAFF	D 236
➤ See page 73 for details and meeting times.					

AUTOMOTIVE COLLISION REPAIR

AUTOMOTIVE COLLISION REPAIR 114 3.00 UNITS					
BASIC WELDING THEORY AND PRACTICES					
7300	lec	7:00am - 7:45am	TWThF	B.E. FERRE	F 120
&	lab	7:45am - 12:45pm	TWThF	B.E. FERRE	F 110
<i>(6 Week Class - Starts 2/9/2010, Ends 3/19/2010)</i>					

AUTOMOTIVE COLLISION REPAIR 115 3.00 UNITS					
AUTO BODY CONSTRUCTION					
7301	lec	7:00am - 7:45am	TWThF	B.E. FERRE	F 120
&	lab	7:45am - 12:45pm	TWThF	B.E. FERRE	F 110
<i>(6 Week Class - Starts 3/23/2010, Ends 4/30/2010)</i>					

AUTOMOTIVE COLLISION REPAIR 116 3.00 UNITS					
BASIC COLLISION REPAIR					
7302	lec	7:00am - 7:45am	TWThF	B.E. FERRE	F 120
&	lab	7:45am - 12:45pm	TWThF	B.E. FERRE	F 110
<i>(6 Week Class - Starts 5/4/2010, Ends 6/4/2010)</i>					

AUTOMOTIVE COLLISION REPAIR 124 3.00 UNITS					
INTERMEDIATE COLLISION REPAIR-PARTS & REPLACEMENT ALIGNMENT					
7303	lec	7:00am - 7:45am	TWThF	B.E. FERRE	F 120
&	lab	7:45am - 12:45pm	TWThF	B.E. FERRE	F 110
<i>(6 Week Class - Starts 2/9/2010, Ends 3/19/2010)</i>					

AUTOMOTIVE COLLISION REPAIR 125 3.00 UNITS					
INTERMEDIATE COLLISION REPAIR-METAL REPAIR AND REFINISHING					
7304	lec	7:00am - 7:45am	TWThF	B.E. FERRE	F 120
&	lab	7:45am - 12:45pm	TWThF	B.E. FERRE	F 110
<i>(6 Week Class - Starts 3/23/2010, Ends 4/30/2010)</i>					
Evening Class					
4375	lec	6:45pm - 7:15pm	MW	S. MURADIAN	F 120
&	lab	7:15pm - 10:30pm	MW	S. MURADIAN	F 120

AUTOMOTIVE COLLISION REPAIR 126 3.00 UNITS					
INTERMEDIATE COLLISION REPAIR-FRAME STRAIGHTENING					
7305	lec	7:00am - 7:45am	TWThF	B.E. FERRE	F 120
&	lab	7:45am - 12:45pm	TWThF	B.E. FERRE	F 110
<i>(6 Week Class - Starts 5/4/2010, Ends 6/4/2010)</i>					

AUTOMOTIVE COLLISION REPAIR 134 3.00 UNITS					
BODY PANEL REPLACEMENT					
7306	lec	12:55pm - 1:45pm	TWThF	F.J. MORAGO	F 120
&	lab	1:45pm - 6:45pm	TWThF	F.J. MORAGO	F 110
<i>(6 Week Class - Starts 2/9/2010, Ends 3/19/2010)</i>					

AUTOMOTIVE COLLISION REPAIR 135 3.00 UNITS					
BODY SECTION REPLACEMENT					
7307	lec	12:55pm - 1:45pm	TWThF	F.J. MORAGO	F 120
&	lab	1:45pm - 6:45pm	TWThF	F.J. MORAGO	F 110
<i>(6 Week Class - Starts 3/23/2010, Ends 4/30/2010)</i>					

AUTOMOTIVE COLLISION REPAIR 136 3.00 UNITS					
UNITIZED BODY AND FRAME ALIGNMENT					
7308	lec	12:55pm - 1:45pm	TWThF	F.J. MORAGO	F 120
&	lab	1:45pm - 6:45pm	TWThF	F.J. MORAGO	F 110
<i>(6 Week Class - Starts 5/4/2010, Ends 6/4/2010)</i>					

AUTOMOTIVE COLLISION REPAIR 140 3.00 UNITS					
ADVANCED COLLISION REPAIR-ESTIMATING					
7309	lec	12:55pm - 1:45pm	TWThF	F.J. MORAGO	F 120
&	lab	1:45pm - 6:45pm	TWThF	F.J. MORAGO	F 110
<i>(6 Week Class - Starts 2/9/2010, Ends 3/19/2010)</i>					
Evening Class					
4371	lec	6:45pm - 7:15pm	TTh	F.J. MORAGO	F 120
&	lab	7:15pm - 10:30pm	TTh	F.J. MORAGO	F 120

AUTOMOTIVE COLLISION REPAIR 144 3.00 UNITS					
ADVANCED COLLISION REPAIR-PRIMERS AND PAINTS					
7310	lec	12:55pm - 1:45pm	TWThF	F.J. MORAGO	F 120
&	lab	1:45pm - 6:45pm	TWThF	F.J. MORAGO	F 110
<i>(6 Week Class - Starts 3/23/2010, Ends 4/30/2010)</i>					
7315	lec	8:00am - 9:00am	S	B.E. FERRE	F 120
&	lab	9:00am - 3:30pm	S	B.E. FERRE	F 110

AUTOMOTIVE COLLISION REPAIR 145 3.00 UNITS					
ADVANCED COLLISION REPAIR-SPECIAL PROBLEMS & SOLUTIONS					
7311	lec	12:55pm - 1:45pm	TWThF	F.J. MORAGO	F 120
&	lab	1:45pm - 6:45pm	TWThF	F.J. MORAGO	F 110
<i>(6 Week Class - Starts 5/4/2010, Ends 6/4/2010)</i>					
Evening Class					
4370	lec	6:45pm - 7:15pm	MW	S. MURADIAN	F 120
&	lab	7:15pm - 10:30pm	MW	S. MURADIAN	F 120

AUTOMOTIVE COLLISION REPAIR 148 3.00 UNITS					
PAINT PREPARATION AND APPLICATION					
4372	lec	8:00am - 9:00am	S	B.E. FERRE	F 120
&	lab	9:00am - 3:30pm	S	B.E. FERRE	F 110

AUTOMOTIVE COLLISION REPAIR 149 3.00 UNITS					
ESTIMATING BODY DAMAGE					
Evening Class					
4374	lec	6:45pm - 7:15pm	TTh	F.J. MORAGO	F 120
&	lab	7:15pm - 10:30pm	TTh	F.J. MORAGO	F 110

AUTOMOTIVE COLLISION REPAIR 226 3.00 UNITS					
AUTOMOTIVE COLLISION REPAIR I					
Evening Class					
4377	lec	6:45pm - 7:15pm	MW	S. MURADIAN	F 120
&	lab	7:15pm - 10:30pm	MW	S. MURADIAN	F 110

BAKING, PROFESSIONAL

BAKING, PROFESSIONAL 101 2.00 UNITS					
ASSEMBLING AND DECORATING CAKES					
7550	lec	7:00am - 9:20am	F	D.M. THOMPSON	H 315
&	lab	9:20am - 2:45pm	F	D.M. THOMPSON	H 330
<i>(8 Week Class - Starts 2/12/2010, Ends 4/9/2010)</i>					

BAKING, PROFESSIONAL 112 6.00 UNITS					
BAKING PROCESSES AND THEORY OF INGREDIENTS					
7541	lec	8:00am - 10:00am	MTWTh	R.B. WEMISCHNER	H 315
&	lab	10:00am - 1:35pm	MTWTh	R.B. WEMISCHNER	H 330
<i>(8 Week Class - Starts 4/12/2010, Ends 6/7/2010)</i>					
7549	lec	8:00am - 10:00am	MTWTh	R.B. WEMISCHNER	H 315
&	lab	10:00am - 1:35pm	MTWTh	R.B. WEMISCHNER	H 315
<i>(8 Week Class - Starts 2/8/2010, Ends 4/9/2010)</i>					

BAKING, PROFESSIONAL 121 6.00 UNITS					
BAKING PROCEDURES AND THEORY OF INGREDIENTS I					
7542	lab	6:45am - 10:25am	MTWTh	S.D. DAMASO	H 330
&	lec	10:25am - 12:25pm	MTWTh	S.D. DAMASO	H 315
<i>(8 Week Class - Starts 2/8/2010, Ends 4/9/2010)</i>					

BAKING, PROFESSIONAL 122 6.00 UNITS
BAKING PROCESSES AND INGREDIENT CONTROL I
 7543 lec 6:45am - 10:25am MTWTh S.D. DAMASO H 330
 & lab 10:25am - 12:20pm MTWTh S.D. DAMASO H 315
(8 Week Class - Starts 4/12/2010, Ends 6/7/2010)

BAKING, PROFESSIONAL 131 6.00 UNITS
BAKING PROCEDURES AND THEORY OF INGREDIENTS II
 7544 lec 6:30am - 8:30am MTWTh D.M. THOMPSON H 334
 & lab 8:30am - 12:05pm MTWTh D.M. THOMPSON H 315
(8 Week Class - Starts 2/8/2010, Ends 4/9/2010)

BAKING, PROFESSIONAL 132 6.00 UNITS
BAKING PROCESSES AND INGREDIENT CONTROL II
 7545 lec 6:30am - 8:30am MTWTh D.M. THOMPSON H 334
 & lab 8:30am - 12:05pm MTWTh D.M. THOMPSON H 330
(8 Week Class - Starts 4/12/2010, Ends 6/7/2010)

BAKING, PROFESSIONAL 141 6.00 UNITS
BAKING PROCEDURES AND THEORY OF INGREDIENTS III
 7546 lec 6:30am - 8:30am MTWTh D.M. THOMPSON H 334
 & lab 8:30am - 12:05pm MTWTh D.M. THOMPSON H 330
(8 Week Class - Starts 2/8/2010, Ends 4/9/2010)

BAKING, PROFESSIONAL 142 6.00 UNITS
BAKING PROCESSES AND INGREDIENT CONTROL III
 7547 lec 6:30am - 8:30am MTWTh D.M. THOMPSON H 334
 & lab 8:30am - 12:05pm MTWTh D.M. THOMPSON H 330
(8 Week Class - Starts 4/12/2010, Ends 6/7/2010)

BIOLOGY

BIOLOGY 003 4.00 UNITS
INTRODUCTION TO BIOLOGY (UC:CSU)

Introduction to the fundamental properties of living things.

1610 lec 7:00am - 9:05am M X.V. WRIGHT K 468
 & lec 7:00am - 9:05am W X.V. WRIGHT K 468
 & lab 7:00am - 9:05am F X.V. WRIGHT K 468
 1611 lec 12:00pm - 3:10pm T M.C. PANTASTICO CALDAS K 408
 & lab 12:00pm - 3:10pm Th M.C. PANTASTICO CALDAS K 408
 1613 lec 8:00am - 11:10am S R.L. STEWART K 468
 & lab 12:00pm - 3:10pm S R.L. STEWART K 468

Evening Class
 4050 lec 6:00pm - 9:10pm M B.D. OLSEN K 468
 & lab 6:00pm - 9:10pm W B.D. OLSEN K 468
 4051 lec 6:00pm - 9:10pm T K. NEDDERMEYER K 408
 & lab 6:00pm - 9:10pm Th K. NEDDERMEYER K 408
 4052 lec 6:00pm - 9:10pm M S.W. LAVINGER K 420
 & lab 6:00pm - 9:10pm W S.W. LAVINGER K 420

BIOLOGY 007 5.00 UNITS
GENERAL BIOLOGY II (UC:CSU)

Prerequisite: Biology 6 and Math 125 or higher.
 Basic principles of biology.

1621 lec 9:05am - 12:10pm M M.C. PANTASTICO CALDAS K 468
 & lab 9:05am - 12:10pm WF M.C. PANTASTICO CALDAS K 468

BIOLOGY 020 8.00 UNITS
HUMAN ANATOMY AND PHYSIOLOGY (UC:CSU)

Prerequisite: Biology 3 or 36 with a grade of "C" or better

1630 lec 8:35am - 11:45am MW R.K. WONG K 406
 & lab 8:00am - 11:10am T R.K. WONG K 468
 & lab 8:00am - 11:10am Th R.K. WONG K 468
 1631 lec 8:35am - 11:45am MW R.K. WONG K 406
 & lab 11:20am - 2:30pm T R.K. WONG K 468
 & lab 11:20am - 2:30pm Th R.K. WONG K 468
 1632 lec 2:40pm - 5:50pm MW T.L. DENTON K 406
 & lab 2:40pm - 5:50pm T T.L. DENTON K 468
 & lab 2:40pm - 5:50pm Th T.L. DENTON K 468

1633 lec 2:40pm - 5:50pm MW T.L. DENTON K 406
 & lab 6:00pm - 9:10pm T T.L. DENTON K 468
 & lab 6:00pm - 9:10pm Th T.L. DENTON K 468

BIOLOGY 036 4.00 UNITS
BIOSCIENCE FOR HEALTH OCCUPATIONS

1640 lec 12:30pm - 3:40pm M STAFF K 468
 & lab 12:30pm - 3:40pm W STAFF K 468
 1641 lec 8:00am - 11:10am F O.B. GBONEGUN K 406
 & lab 12:00pm - 3:10pm F O.B. GBONEGUN K 408

BUILDING CONSTRUCTION TECHNIQUES

BUILDING CONSTRUCTION TECHNIQUES 002 3.00 UNITS
PRE-EMPLOYMENT -APPLIED TRADES CALCULATIONS AND MEASUREMENT

8331 lec 12:00pm - 1:25pm TTh STAFF B 301

BUILDING CONSTRUCTION TECHNIQUES 003 2.00 UNITS
MATERIALS OF THE BUILDING INDUSTRY

8332 lab 1:30pm - 4:40pm TTh STAFF B 301

BUILDING CONSTRUCTION TECHNIQUES 004 3.00 UNITS
PRINCIPLES OF HAND AND POWER TOOLS

8333 lab 1:30pm - 4:40pm MWF STAFF B 301

BUILDING CONSTRUCTION TECHNIQUES 101 3.00 UNITS
CONTRACT'S LICENSE LAW (CSU)

Evening Class
 4824 lec 6:00pm - 9:10pm F G.A. THOMPSON B 336

BUSINESS

BUSINESS 001 3.00 UNITS
INTRODUCTION TO BUSINESS (UC:CSU)

0130 lec 10:10am - 11:35am MW M.C. BESSLER K 262
 0131 lec 8:35am - 10:00am TTh J. AHMAD K 321
 0132 lec 8:00am - 11:10am S S.B. SCUDDER K 262

Evening Class
 3016 lec 6:00pm - 9:10pm M R.S. SHERER K 262

BUSINESS 005 3.00 UNITS
BUSINESS LAW I (UC:CSU)

0134 lec 1:15pm - 2:40pm MW K.L. GARY K 204
 0135 lec 10:10am - 11:35am TTh K.L. GARY K 204

Evening Class
 3021 lec 6:00pm - 9:10pm Th J.D. ENDMAN K 262

BUSINESS 032 3.00 UNITS
BUSINESS COMMUNICATIONS (CSU)

0145 lec 1:00pm - 2:00pm MW D.M. THORNHILL K 320
 & lab 2:00pm - 3:15pm MW D.M. THORNHILL K 320

BUSINESS 038 3.00 UNITS
BUSINESS COMPUTATIONS (CSU)

0146 lec 8:35am - 10:00am MW J. AHMAD K 321
 0147 lec 10:10am - 11:35am TTh R.S. SHERER K 262

Evening Class
 3024 lec 6:00pm - 9:10pm W R.S. SHERER K 262

BUSINESS 040						3.00 UNITS
BUSINESS PROJECT MANAGEMENT (CSU)						
Evening Class						
3026	lec	5:00pm - 9:10pm	T	Y.O. TOURE		K 307
BUSINESS 941						4.00 UNITS
COOPERATIVE EDUCATION - BUSINESS (CSU)						
9032	lec	4:25 hrs/wk	TBA	STAFF		D 236
➤ See page 73 for details and meeting times.						

CABINET MAKING AND MILLWORK

CABINET MAKING AND MILLWORK 170						3.00 UNITS
INTRODUCTION TO CNC WOODWORKING MACHINING CENTER						
Furniture and other CNC applications.						
4823	lec	12:30pm - 1:15pm	TTh	L. HUBBARD		B 120
	Team	lab	1:15pm - 3:15pm	TTh	L. HUBBARD	B 131

CARPENTRY

CARPENTRY 105						3.00 UNITS
CALCULATIONS AND MEASUREMENT FOR WOODWORKING STUDENTS I						
8103	lec	10:40am - 12:10pm	TTh	L. HUBBARD		B 136
Evening Class						
8107	lec	6:00pm - 9:10pm	T	W.G. HANLEY		B 134
CARPENTRY 111A						3.00 UNITS
CONSTRUCTION IA						
Use and operation of standard industry tools.						
Evening Class						
4700	lec	6:00pm - 9:10pm	M	W.G. HANLEY		B 102
CARPENTRY 114						4.00 UNITS
HAND AND POWER TOOL APPLICATION						
8104	lec	7:00am - 7:20am	MWF	L. HUBBARD		B 136
	&	lab	7:20am - 10:30am	MWF	L. HUBBARD	B 104
CARPENTRY 115						3.00 UNITS
BASIC BLUEPRINT READING						
8105	lec	7:00am - 7:20am	TTh	L. HUBBARD		B 136
	&	lab	7:20am - 10:30am	TTh	L. HUBBARD	B 104
CARPENTRY 117						2.00 UNITS
CONSTRUCTION MATERIALS						
8106	lec	10:40am - 11:00am	MWF	L. HUBBARD		B 136
	&	lab	11:10am - 12:10pm	MWF	L. HUBBARD	B 104
CARPENTRY 123						4.00 UNITS
BASIC HOUSE CONSTRUCTION						
8114	lec	7:00am - 7:50am	MW	W.G. HANLEY		B 105
	&	lab	7:00am - 10:10am	TTh	W.G. HANLEY	B 120
CARPENTRY 124						3.00 UNITS
BLUEPRINT READING II						
8115	lec	7:00am - 7:50am	F	W.G. HANLEY		B 105
	&	lab	8:00am - 10:10am	MWF	W.G. HANLEY	B 104
CARPENTRY 129						2.00 UNITS
BASIC RESIDENTIAL ESTIMATING						
8116	lab	10:10am - 12:20pm	MWF	W.G. HANLEY		B 104

CARPENTRY 130						3.00 UNITS
CALCULATIONS AND MEASUREMENT FOR WOODWORKING STUDENTS II						
8110	lec	10:20am - 11:45am	TTh	T.J. VESSELLA		B 102
CARPENTRY 132						3.00 UNITS
APPLIED BLUEPRINT READING						
8118	lec	6:45am - 7:35am	F	R.W. DUNN		B 105
	&	lab	8:25am - 10:45am	MWF	R.W. DUNN	B 104
CARPENTRY 133						3.00 UNITS
ADVANCED RESIDENTIAL ESTIMATING						
8119	lec	7:00am - 8:25am	MW	R.W. DUNN		B 105
CARPENTRY 134						4.00 UNITS
ADVANCED RESIDENTIAL CONSTRUCTION						
8120	lec	7:00am - 8:25am	TTh	R.W. DUNN		B 105
	&	lab	8:25am - 10:50am	TTh	R.W. DUNN	B 104
CARPENTRY 135						2.00 UNITS
CONCRETE CONSTRUCTION						
8121	lec	7:35am - 8:25am	F	R.W. DUNN		B 105
	&	lab	10:50am - 11:30am	MTWThF	R.W. DUNN	B 104
CARPENTRY 144						4.00 UNITS
RESIDENTIAL EXTERIOR FINISH						
8131	lab	7:00am - 8:05am	M	R.W. DUNN		B 102
	&	lec	8:15am - 11:25am	MWF	R.W. DUNN	B 104
CARPENTRY 145						5.00 UNITS
RESIDENTIAL INTERIOR FINISH						
8132	lab	7:00am - 8:05am	WF	R.W. DUNN		B 102
	&	lec	7:00am - 11:55am	TTh	R.W. DUNN	B 104
CARPENTRY 148						3.00 UNITS
COMPUTER ASSISTED ESTIMATING I						
Evening Class						
4706	lec	6:00pm - 6:50pm	MW	G.K. WOO		C 201
	&	lab	6:50pm - 9:10pm	MW	G.K. WOO	C 201
CARPENTRY 240						4.00 UNITS
BUILDING CONSTRUCTION SPECIALTIES						
Evening Class						
4701	lec	6:00pm - 7:10pm	TTh	R.W. DUNN		B 102
	&	lab	7:10pm - 9:40pm	TTh	R.W. DUNN	B 102
CARPENTRY 241						3.00 UNITS
BLUEPRINT READING AND ESTIMATING						
Evening Class						
4702	lec	6:00pm - 9:10pm	W	R.J. LAWRENCE		B 105
CARPENTRY 247						3.00 UNITS
BUILDING ESTIMATING II						
Evening Class						
4703	lec	6:00pm - 9:10pm	T	H. PORTER		B 105
CARPENTRY 252						3.00 UNITS
UNIFORM BUILDING CODE II						
Evening Class						
4704	lec	6:00pm - 9:10pm	F	R.J. LAWRENCE		B 105
CARPENTRY 941						4.00 UNITS
COOPERATIVE EDUCATION - CARPENTRY						
9040	lab	4:25 hrs/wk	TBA	C.A. MORLEY MOWER		D 236
➤ See page 73 for details and meeting times.						

CHEMICAL TECHNOLOGY

CHEMICAL TECHNOLOGY 121						5.00 UNITS
APPLIED CHEMISTRY II (CSU)						
1650	lec	7:00am - 8:25am	M	V. HARUTUNIAN	K 464	
&	lec	10:20am - 11:05am	M	V. HARUTUNIAN	K 464	
&	lec	7:00am - 7:50am	T	V. HARUTUNIAN	K 464	
&	lab	7:50am - 11:05am	T	V. HARUTUNIAN	K 464	
&	lab	8:00am - 11:10am	F	D.A. JEFFRESS	K 464	
CHEMICAL TECHNOLOGY 123						2.00 UNITS
APPLIED CHEMISTRY MATHEMATICS II						
1651	lec	10:20am - 12:25pm	W	R.M. MADYUN	K 464	
CHEMICAL TECHNOLOGY 131						3.00 UNITS
INDUSTRIAL PROCESSES						
1656	lec	6:30am - 7:40am	W	R.M. MADYUN	K 466	
&	lab	7:40am - 9:40am	W	R.M. MADYUN	K 466	
&	lab	7:00am - 11:45am	Th	R.M. MADYUN	K 466	
CHEMICAL TECHNOLOGY 141						1.00 UNIT
BASIC EMPLOYMENT INFORMATION						
1657	lec	6:25am - 7:00am	MT	R.M. MADYUN	K 424	
CHEMICAL TECHNOLOGY 142						5.00 UNITS
QUANTITATIVE AND INSTRUMENTAL ANALYSIS II						
1658	lec	7:00am - 8:25am	MT	R.M. MADYUN	K 466	
&	lab	8:25am - 11:35am	MT	R.M. MADYUN	K 466	
CHEMICAL TECHNOLOGY 143						4.00 UNITS
ORGANIC CHEMISTRY II (CSU)						
1659	lec	10:05am - 12:45pm	W	V. HARUTUNIAN	K 466	
&	lab	6:30am - 12:50pm	F	V. HARUTUNIAN	K 466	
CHEMICAL TECHNOLOGY 161						1.00 UNIT
SPECIAL PROJECTS I						
1660	lab	3:15 hrs/wk	TBA	V. HARUTUNIAN	K 405	
CHEMICAL TECHNOLOGY 162						2.00 UNITS
SPECIAL PROJECTS II						
1661	lab	6:30 hrs/wk	TBA	V. HARUTUNIAN	K 424	

CHEMISTRY

CHEMISTRY 051						5.00 UNITS
FUNDAMENTALS OF CHEMISTRY I (UC:CSU)						
Prerequisite: Math 115 or Math 113 and 114 or higher.						
1670	lec	10:10am - 11:45am	MW	M. DIAZ	K 422	
&	lec	11:45am - 1:00pm	W	B.E. RUIZ SILVA	K 406	
&	lab	9:00am - 12:00pm	Th	K.F. HOUBEN	K 464	
1671	lec	10:10am - 11:45am	MW	M. DIAZ	K 422	
&	lec	11:45am - 1:00pm	W	B.E. RUIZ SILVA	K 406	
&	lab	12:00pm - 3:00pm	Th	V. SACHDEV	K 464	
1672	lec	10:10am - 12:10pm	TTh	B.E. RUIZ SILVA	K 406	
&	lab	12:10pm - 3:10pm	T	H.O. AJIE	K 464	
1674	lab	8:00am - 11:10am	S	S.H. PARKIN	K 464	
&	lec	12:00pm - 4:25pm	S	S.H. PARKIN	K 301	
Evening Class						
4070	lec	4:45pm - 6:50pm	TTh	H.O. AJIE	K 464	
&	lab	6:50pm - 10:00pm	T	H.O. AJIE	K 464	
CHEMISTRY 070						4.00 UNITS
INTRODUCTORY ORGANIC AND BIOCHEMISTRY (UC:CSU)						
Prerequisite: Chemistry 51 or 65 or 101 with a grade of "C" or better.						
1634	lec	8:00am - 11:10am	S	P.M. DARMANYAN	K 204	
&	lab	12:00pm - 3:10pm	S	P.M. DARMANYAN	K 464	

CHEMISTRY 101						5.00 UNITS
GENERAL CHEMISTRY I (UC:CSU)						
Prerequisite: Math 125 or higher with a grade of "C" or better.						
1680	lec	10:10am - 11:50am	MW	K.F. HOUBEN	K 424	
&	lab	12:00pm - 3:00pm	MW	STAFF	K 466	
1695	lec	10:10am - 11:50am	TTh	M. DIAZ	K 422	
&	lab	11:50am - 3:00pm	TTh	STAFF	K 466	
Evening Class						
4075	lec	4:35pm - 6:00pm	TTh	K.F. HOUBEN	K 422	
&	lab	6:10pm - 9:20pm	TTh	M.Z. VISI	K 466	
CHEMISTRY 102						5.00 UNITS
GENERAL CHEMISTRY II (UC:CSU)						
Prerequisite: Chemistry 101 and Math 125 or higher with a grade of "C" or better.						
1682	lec	1:10pm - 2:50pm	TTh	M. DIAZ	K 262	
&	lab	3:00pm - 6:00pm	TTh	M. DIAZ	K 466	
Evening Class						
4076	lec	4:35pm - 6:00pm	MW	K.F. HOUBEN	K 422	
&	lab	6:10pm - 9:20pm	MW	K.F. HOUBEN	K 466	
CHEMISTRY 185						1.00 UNIT
DIRECTED STUDY - CHEMISTRY (UC:CSU)						
1683	lec	1:05 hrs/wk	TBA	M. DIAZ	K 422	
CHEMISTRY 211						5.00 UNITS
ORGANIC CHEMISTRY FOR SCIENCE MAJORS I (UC:CSU)						
Prerequisite: Chem 102 with a grade of "C" or better.						
1684	lec	1:10pm - 2:30pm	WF	B.E. RUIZ SILVA	K 406	
&	lab	2:30pm - 6:00pm	WF	B.E. RUIZ SILVA	K 464	
CHEMISTRY 212						5.00 UNITS
ORGANIC CHEMISTRY FOR SCIENCE MAJORS II (UC:CSU)						
Prerequisite: Chemistry 211 with a grade of "C" or better.						
1685	lec	1:10pm - 2:50pm	MW	M. DIAZ	K 262	
&	lab	3:00pm - 6:00pm	MW	M. DIAZ	K 466	
1687	lec	1:10pm - 3:00pm	MW	M. DIAZ	K 262	
&	lab	6:00pm - 9:10pm	MW	STAFF	K 464	
CHEMISTRY 221						5.00 UNITS
BIOCHEMISTRY FOR SCIENCE MAJORS (UC:CSU)						
Prerequisite: Chemistry 211 with a grade of "C" or better.						
1699	lec	1:10pm - 3:00pm	TTh	B.E. RUIZ SILVA	K 406	
&	lab	3:00pm - 6:00pm	TTh	B.E. RUIZ SILVA	K 464	
CHEMISTRY 285						2.00 UNITS
DIRECTED STUDY - CHEMISTRY (UC:CSU)						
1681	lec	2:15 hrs/wk	TBA	M. DIAZ	K 424	
CHEMISTRY 385						3.00 UNITS
DIRECTED STUDY - CHEMISTRY (UC:CSU)						
1686	lec	3:15 hrs/wk	TBA	B.E. RUIZ SILVA	K 464	

CHILD DEVELOPMENT

CHILD DEVELOPMENT 001						3.00 UNITS
CHILD GROWTH AND DEVELOPMENT (UC:CSU)						
Advisory: English 28.						
Childhood development from conception through adolescence.						
1201	lec	8:35am - 10:00am	MW	C. VEGA	F 222	
1202	lec	10:10am - 11:35am	MW	M.T. ROSTAMI	H 301	
1203	lec	8:35am - 10:00am	TTh	J.Y. BABB	F 222	
1204	lec	10:10am - 11:35am	TTh	J.Y. BABB	F 222	
1206	lec	9:00am - 12:10pm	S	R.W. ESSEX	F 209	
7931	lec	3:15 hrs/wk	TBA	J.Y. BABB	ON LINE	
➤ Please visit the online program homepage at http://moodle.lattc.edu prior to the start of class for directions, or see pages 70-72 of this schedule for more information.						
Evening Class						
3720	lec	6:00pm - 9:10pm	T	R.G. MAINA	F 222	
3721	lec	5:00pm - 8:10pm	W	R.B. ESTROFF	F 222	

Child Development Courses Flow Chart

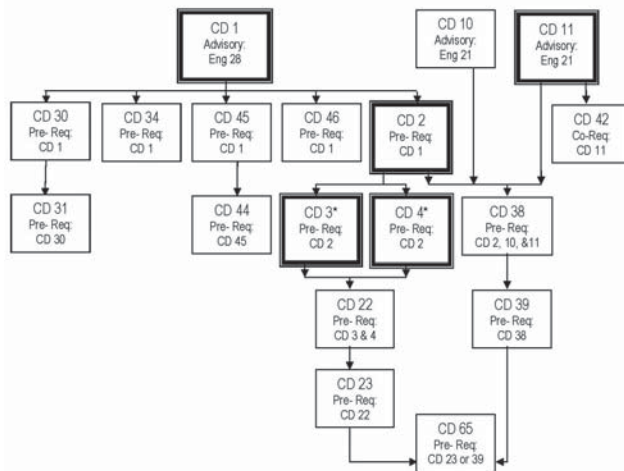

Core Courses

* It is not recommended to take both CD 3 & 4 at the same time.

CHILD DEVELOPMENT 002 3.00 UNITS
EARLY CHILDHOOD: PRINCIPLES AND PRACTICES (CSU)

TB clearance required. Prerequisite: Child Development 1.
 1208 lec 8:35am - 10:00am MW J.Y. BABB H 314
 1209 lec 10:10am - 11:35am TTh C. VEGA H 337
Evening Class
 3723 lec 6:00pm - 9:10pm Th R.G. MAINA F 210

CHILD DEVELOPMENT 003 3.00 UNITS
CREATIVE EXPERIENCES FOR CHILDREN I (CSU)

Prerequisite: Child Development 2.
 Curriculum and lesson planning: art, music and rhythmic movement.
Evening Class
 3725 lec 6:00pm - 9:10pm M R.G. MAINA H 340

CHILD DEVELOPMENT 004 3.00 UNITS
CREATIVE EXPERIENCES FOR CHILDREN II (CSU)

Prerequisite: Child Development 2.
 Curriculum and lesson planning: math and science.
 1213 lec 11:45am - 2:55pm W C. VEGA H 340
Evening Class
 3726 lec 5:30pm - 8:40pm M A. CHELSTROM H 337

CHILD DEVELOPMENT 010 3.00 UNITS
CHILD HEALTH (CSU)

Advisory: English 21.
 1215 lec 11:45am - 1:10pm MW G.J. RODRIGUEZ H 314
 1216 lec 8:35am - 10:00am TTh C. VEGA H 337
 1217 lec 9:00am - 12:10pm S J. WILLIAMS F 222
Evening Class
 3709 lec 6:00pm - 9:10pm Th D.E. DICKERSON F 235

CHILD DEVELOPMENT 011 3.00 UNITS
HOME, SCHOOL, AND COMMUNITY RELATIONS (CSU)

Advisory: English 21.
 1218 lec 10:10am - 11:35am MW J.Y. BABB H 314
 1219 lec 11:45am - 1:10pm TTh C. VEGA H 337
Evening Class
 3728 lec 6:00pm - 9:10pm M I.H. KAPLAN F 223

CHILD DEVELOPMENT 022 4.00 UNITS
PRACTICUM IN CHILD DEVELOPMENT I (CSU)

Prerequisite: Child Development 3, 4.
 Students are required to complete 90 hours an approved field site. Must be available between 8:00 a.m. and noon.
Evening Class
 3741 lec 6:00pm - 8:05pm W R.G. MAINA H 340
 & lab 6:45 hrs/wk TBA R.G. MAINA H 340

CHILD DEVELOPMENT 023 4.00 UNITS
PRACTICUM IN CHILD DEVELOPMENT II (CSU)

Prerequisite: Child Development 22.
Evening Class
 3743 lec 6:00pm - 8:05pm W M.A. LOVETT H 301
 & lab 6:45 hrs/wk TBA M.A. LOVETT H 301

CHILD DEVELOPMENT 031 3.00 UNITS
INFANT AND TODDLER STUDIES II (CSU)

Prerequisite: Child Development 30.
 1223 lec 11:45am - 1:10pm TTh R.M. MCLAUGHLIN F 231
Evening Class
 3718 lec 6:00pm - 9:10pm M M.D. BENJAMIN H 314

CHILD DEVELOPMENT 034 3.00 UNITS
OBSERVING AND RECORDING CHILDREN'S BEHAVIOR (CSU)

Prerequisite: Child Development 1.
 1226 lec 10:10am - 11:35am MW E.A. GOMEZ F 222
Evening Class
 3745 lec 5:00pm - 8:10pm Th W.S. KIEL F 222

CHILD DEVELOPMENT 039 3.00 UNITS
ADMINISTRATION & SUPERVISION OF EARLY CHILDHOOD PROGRAMS II (CSU)

Prerequisite: Child Development 38.
Evening Class
 3746 lec 6:00pm - 9:10pm W M.J. UDEOCHU F 215

CHILD DEVELOPMENT 042 3.00 UNITS
THE CHILD IN A DIVERSE SOCIETY (CSU)

Corequisite: Child Development 11.
 1227 lec 11:45am - 1:10pm TTh J.Y. BABB F 222

CHILD DEVELOPMENT 044 3.00 UNITS
PROGRAMS FOR CHILDREN WITH SPECIAL NEEDS I (CSU)

Prerequisite: Child Development 45.
 1231 lec 10:10am - 11:35am MW C. VEGA H 337

CHILD DEVELOPMENT 047 3.00 UNITS
SCHOOL AGE PROGRAMS II (CSU)

1251 lec 8:35am - 10:00am TTh STAFF H 314
Evening Class
 3727 lec 6:00pm - 9:10pm W M.R. DEZGARAN H 314

CHILD DEVELOPMENT 941 4.00 UNITS
COOPERATIVE EDUCATION - CHILD DEVELOPMENT (CSU)

9048 lec 4:25 hrs/wk TBA STAFF D 236
 > See page 73 for details and meeting times.

COMMUNITY PLANNING & ECONOMIC DEVELOPMENT

COMMUNITY PLANNING & ECONOMIC DEVELOPMENT 006 3.00 UNITS
MANAGING NON-PROFIT AND PUBLIC ORGANIZATIONS (CSU)

Evening Class
 4995 lec 6:00pm - 9:10pm W C.M. SANDOVAL F 231

COMMUNITY PLANNING & ECONOMIC DEVELOPMENT 007 3.00 UNITS
POPULAR EDUCATION AND ORGANIZING (CSU)

6890 lec 8:50am - 9:40am MTWThF STAFF ENMT CHAR
 > Environmental Charter High School, 16315 Grevillea Avenue, Lawndale, CA 90260
 6891 lec 10:10am - 11:00am MTWThF STAFF ENMT CHAR
 > Environmental Charter High School, 16315 Grevillea Avenue, Lawndale, CA 90260

COMMUNITY PLANNING & ECONOMIC DEVELOPMENT 011 3.00 UNITS
PROFESSIONAL DEVELOPMENT SKILLS / ISSUES IN COMMUNITY DEVELOPMENT (CSU)

Evening Class
 4952 lec 5:30pm - 9:35pm M B. TORRES F 229
 (14 Week Class - Starts 2/22/2010, Ends 6/7/2010)

COMMUNITY PLANNING & ECONOMIC DEVELOPMENT 036 3.00 UNITS
INTRODUCTION TO APPLIED COMMUNITY DEVELOPMENT RESEARCH
(UC:CSU)

Evening Class
 4951 lec 5:30pm - 8:40pm M STAFF F 235

COMMUNITY PLANNING & ECONOMIC DEVELOPMENT 037 1.00 UNIT
LEADERSHIP DEVELOPMENT: EFFECTIVE STRATEGIES FOR BUILDING
THE CAPACITY OF INDIVIDUALS (CSU)

6896 lec 1:30pm - 3:50pm F STAFF LA CAUS
(7 Week Class - Starts 2/26/2010, Ends 4/16/2010)
 > LA CAUSA YOUTH BLD 1117 GOODRICH BLVD, CA 90022

COMMUNITY PLANNING & ECONOMIC DEVELOPMENT 040 2.00 UNITS
NON-PROFIT PROGRAM DESIGN AND DEVELOPMENT (UC:CSU)

6895 lec 8:30am - 11:35am F STAFF LA CAUS
(11 Week Class - Starts 2/26/2010, Ends 5/14/2010)
 > LA CAUSA YOUTH BLD 1117 GOODRICH BLVD, CA 90022

COMMUNITY PLANNING & ECONOMIC DEVELOPMENT 065 3.00 UNITS
COMMUNITY-BASED HEALTH POLICY ADVOCACY

Evening Class
 4963 lec 5:30pm - 8:40pm W STAFF F 235

COMMUNITY PLANNING & ECONOMIC DEVELOPMENT 071 2.00 UNITS
GREEN BUILDING BASICS FOR DEVELOPERS

8387 lec 9:00am - 11:05am S D.G. FAIRCHILD F 242

COMPUTER APPLICATIONS OFFICE TECHNOLOGIES

COMPUTER APPLICATIONS OFFICE TECHNOLOGIES 001 3.00 UNITS
COMPUTER KEYBOARDING I (CSU)

Fundamentals of keyboarding and letter writing.
 0201 lec 10:15am - 11:20am MW D.M. THORNHILL K 320
 & lab 11:20am - 12:45pm MW D.M. THORNHILL K 320
 0203 lec 1:10pm - 2:15pm TTh O.K. KAPAKU K 208
 & lab 2:15pm - 3:40pm TTh O.K. KAPAKU K 208

Evening Class
 3046 lec 6:00pm - 7:05pm TTh V.T. PALACIOS K 320
 & lab 7:05pm - 8:30pm TTh V.T. PALACIOS K 320

COMPUTER APPLICATIONS OFFICE TECHNOLOGIES 002 3.00 UNITS
COMPUTER KEYBOARDING II (CSU)

Increase computer keyboarding skills and improve business and legal document development in MS Word.
 0205 lec 10:15am - 11:20am TTh P. BAILEY K 208
 & lab 11:20am - 12:45pm TTh P. BAILEY K 208

COMPUTER APPLICATIONS OFFICE TECHNOLOGIES 003 3.00 UNITS
COMPUTER KEYBOARDING III (CSU)

Further increase keyboarding skills and legal document development.
 0206 lec 10:15am - 11:20am TTh P. BAILEY K 208

COMPUTER APPLICATIONS OFFICE TECHNOLOGIES 007 3.00 UNITS
MACHINE TRANSCRIPTION (CSU)

Voice transcription keyboarding.
 0210 lec 8:00am - 9:05am MW D.M. THORNHILL K 320
 & lab 9:05am - 10:05am MW D.M. THORNHILL K 320

COMPUTER APPLICATIONS OFFICE TECHNOLOGIES 030 3.00 UNITS
OFFICE PROCEDURES (CSU)

0230 lec 8:00am - 9:00am MW E.J. CHU K 208
 & lab 9:00am - 10:05am MW E.J. CHU K 208

COMPUTER APPLICATIONS OFFICE TECHNOLOGIES 031 3.00 UNITS
BUSINESS ENGLISH (CSU)

0231 lec 8:00am - 9:25am TTh D.M. THORNHILL K 320

COMPUTER APPLICATIONS OFFICE TECHNOLOGIES 033 2.00 UNITS
RECORDS MANAGEMENT AND FILING

0233 lec 10:15am - 10:40am MW E.J. CHU K 322
 & lab 10:40am - 11:40am MW E.J. CHU K 322

COMPUTER APPLICATIONS OFFICE TECHNOLOGIES 034 2.00 UNITS
BUSINESS TERMINOLOGY (CSU)

0234 lec 8:00am - 10:05am F D. SEETAO K 321

COMPUTER APPLICATIONS OFFICE TECHNOLOGIES 046 3.00 UNITS
MACHINE TRANSCRIPTION FOR MEDICAL SECRETARIES

Transcription of medical communications.
 0236 lec 9:45am - 10:45am TTh D.M. THORNHILL K 320
 & lab 10:50am - 11:50am TTh D.M. THORNHILL K 320

COMPUTER APPLICATIONS OFFICE TECHNOLOGIES 082 3.00 UNITS
MICROCOMPUTER SOFTWARE SURVEY IN THE OFFICE (CSU)

0248 lec 8:00am - 10:10am F P. BAILEY K 208
 & lab 10:10am - 1:20pm F P. BAILEY K 208
 7959 lec 5:15 hrs/wk TBA S.Y. BAKLAYAN ON LINE
 > Please visit the online program homepage at <http://moodle.lattc.edu> prior to the start of class for directions, or see pages 70-72 of this schedule for more information.

Evening Class
 3057 lec 6:00pm - 7:05pm MW P.A. TAYLOR K 320
 & lec 7:05pm - 8:40pm MW P.A. TAYLOR K 320

COMPUTER APPLICATIONS OFFICE TECHNOLOGIES 084 3.00 UNITS
MICROCOMPUTER OFFICE APPLICATIONS: WORD PROCESSING (CSU)

7962 lab 5:15 hrs/wk TBA S.Y. BAKLAYAN ON LINE
 > Please visit the online program homepage at <http://moodle.lattc.edu> prior to the start of class for directions, or see pages 70-72 of this schedule for more information.

COMPUTER APPLICATIONS OFFICE TECHNOLOGIES 085 3.00 UNITS
MICROCOMPUTER OFFICE APPLICATIONS: SPREADSHEET (CSU)

0253 lec 8:00am - 10:00am S S.Y. BAKLAYAN K 208
 & lab 10:00am - 1:20pm S S.Y. BAKLAYAN K 208
 7863 lab 5:15 hrs/wk TBA S.Y. BAKLAYAN ON LINE
 > Please visit the online program homepage at <http://moodle.lattc.edu> prior to the start of class for directions, or see pages 70-72 of this schedule for more information.

COMPUTER APPLICATIONS OFFICE TECHNOLOGIES 086 3.00 UNITS
MICROCOMPUTER OFFICE APPLICATIONS: DATABASE (CSU)

0256 lec 8:00am - 10:10am F S.B. HAYMON K 304
 & lab 10:10am - 1:20pm F S.B. HAYMON K 304

COMPUTER APPLICATIONS OFFICE TECHNOLOGIES 088 3.00 UNITS
MICROCOMPUTER OFFICE APPLICATIONS: DESKTOP PUBLISHING (CSU)

0255 lec 8:00am - 10:10am S W. BURTON K 304
 & lab 10:10am - 1:20pm S W. BURTON K 304

COMPUTER APPLICATIONS OFFICE TECHNOLOGIES 101 1.00 UNIT
HANDS-ON INTERNET (CSU)

Evening Class
 3058 lab 6:00pm - 8:05pm M E.L. PROCTOR K 304

COMPUTER APPLICATIONS OFFICE TECHNOLOGIES 133 1.00 UNIT
HOW TO SUCCEED IN AN ONLINE COURSE

7960 lab 4:15 hrs/wk TBA J.D. PERRET ON LINE
(6 Week Class - Starts 2/8/2010, Ends 3/19/2010)
 > Note: A live, highly recommended in-class orientation will be offered on Friday evening, February 5, 2010, from 6:00 p.m. to 8:00 p.m., in Room K-208. Email Prof_Perret@msn.com for details. Please visit the online homepage at <http://moodle.lattc.edu> prior to the start of class for directions, or see pages 70-72 of this schedule for more information.

COMPUTER INFORMATION SYSTEMS

COMPUTER INFORMATION SYSTEMS 012 WEB SECURITY (CSU) 3.00 UNITS

0161 lec 8:00am - 12:15pm S J. AUCIELLO K 307

COMPUTER INFORMATION SYSTEMS 035 MULTIMEDIA PRESENTATIONS FOR THE INTERNET I (CSU) 3.00 UNITS

Evening Class
3011 lec 6:00pm - 9:05pm W G.W. PHILLIPS K 307
& lab 1:30 hrs/wk TBA G.W. PHILLIPS K 307

COMPUTER INFORMATION SYSTEMS 700 COMPUTER CONCEPTS (CSU) 3.00 UNITS

0152 lec 12:00pm - 1:05pm TTh L.M. HAHNE K 307
& lab 1:05pm - 2:10pm TTh L.M. HAHNE K 307

COMPUTER INFORMATION SYSTEMS 701 INTRODUCTION TO COMPUTERS AND THEIR USES (UC:CSU) 3.00 UNITS

0156 lec 7:00am - 8:05am MW L.M. HAHNE K 307
& lab 8:05am - 9:10am MW L.M. HAHNE K 307
0157 lec 7:00am - 7:30am TTh J. AUCIELLO K 302
& lab 7:30am - 9:10am TTh J. AUCIELLO K 302

Evening Class
3027 lec 6:00pm - 9:05pm T E.L. PROCTOR K 307
& lab 1:05 hrs/wk TBA E.L. PROCTOR K 307

COMPUTER INFORMATION SYSTEMS 733 MICROCOMPUTER DATABASE PROGRAMMING (CSU) 3.00 UNITS

0164 lec 12:00pm - 1:05pm TTh J. AUCIELLO K 302
& lab 1:05pm - 2:10pm TTh J. AUCIELLO K 302

COMPUTER INFORMATION SYSTEMS 739 PROGRAMMING IN C++ (UC:CSU) 3.00 UNITS

0165 lec 12:00pm - 1:05pm MW L.M. HAHNE K 307
& lab 1:05pm - 2:10pm MW L.M. HAHNE K 307

COMPUTER INFORMATION SYSTEMS 743 OBJECT-ORIENTED PROGRAMMING WITH C++ (UC:CSU) 3.00 UNITS

0163 lec 9:15am - 10:20am TTh L.M. HAHNE K 307
& lab 10:20am - 11:25am TTh L.M. HAHNE K 307

COMPUTER INFORMATION SYSTEMS 750 DREAMWEAVER CONCEPTS AND TECHNIQUES 3.00 UNITS

0158 lec 9:15am - 10:20am MW L.M. HAHNE K 307
& lab 10:20am - 11:25am MW L.M. HAHNE K 307

COMPUTER INFORMATION SYSTEMS 757 XHTML PROGRAMMING AND APPLICATIONS (CSU) 3.00 UNITS

0168 lec 9:15am - 10:20am TTh J. AUCIELLO K 302
& lab 10:20am - 11:25am TTh J. AUCIELLO K 302

COMPUTER INFORMATION SYSTEMS 762 WEB SCRIPTING (CSU) 3.00 UNITS

Evening Class
3031 lec 6:00pm - 9:10pm Th D.W. MOORE K 305
& lab 1:05 hrs/wk TBA D.W. MOORE K 305

COMPUTER INFORMATION SYSTEMS 787 NETWORK ESSENTIALS (CSU) 3.00 UNITS

Evening Class
3028 lec 6:00pm - 9:05pm W W.V. TEE K 305
& lab 1:05 hrs/wk TBA W.V. TEE K 305

COMPUTER INFORMATION SYSTEMS 790 PROGRAMMING IN JAVA (UC:CSU) 3.00 UNITS

Evening Class
3029 lec 6:00pm - 9:05pm M J.D. CRUNKLETON K 307
& lab 1:05 hrs/wk TBA J.D. CRUNKLETON K 307

COOPERATIVE EDUCATION

COOPERATIVE EDUCATION 395 WORK EXPERIENCE - GENERAL I (CSU) 3.00 UNITS

9001 lec 5:05 hrs/wk TBA STAFF D 236
& lec 3:10 hrs/wk TBA STAFF D 236
> See page 73 for details and meeting times.

COSMETOLOGY

COSMETOLOGY 035 SKIN THERAPY I 6.00 UNITS

7030 lec 12:30pm - 2:00pm MT L.G. LEY E 216
& lab 2:30pm - 6:00pm MT L.G. LEY A 213
& lec 12:30pm - 2:00pm WTh L.G. LEY E 216
& lab 2:30pm - 6:00pm WTh L.G. LEY A 213
& lec 12:30pm - 2:00pm F L.G. LEY E 216
& lab 2:30pm - 6:00pm F L.G. LEY A 213
(8 Week Class - Starts 2/8/2010, Ends 4/9/2010)

COSMETOLOGY 036 SKIN THERAPY II 6.00 UNITS

Pre-requisite: COSMO 35.
7031 lec 12:30pm - 2:00pm MT L.G. LEY E 216
& lab 2:30pm - 6:00pm MT L.G. LEY A 213
& lec 12:30pm - 2:00pm WTh L.G. LEY E 216
& lab 2:30pm - 6:00pm WTh L.G. LEY A 213
& lec 12:30pm - 2:00pm F L.G. LEY A 213
& lab 2:30pm - 6:00pm F L.G. LEY A 213
(8 Week Class - Starts 4/12/2010, Ends 6/7/2010)

COSMETOLOGY 037 SKIN THERAPY III 6.00 UNITS

Pre-requisite: COSMO 35, 36.
7032 lec 12:30pm - 2:00pm MT L.G. LEY E 216
& lab 2:30pm - 6:00pm MT L.G. LEY A 213
& lec 12:30pm - 1:20pm WTh L.G. LEY E 216
& lab 2:30pm - 6:00pm WTh L.G. LEY A 213
& lec 12:30pm - 2:00pm F L.G. LEY E 216
& lab 2:30pm - 6:00pm F L.G. LEY A 213
(8 Week Class - Starts 2/8/2010, Ends 4/9/2010)

COSMETOLOGY 038 SKIN THERAPY IV 6.00 UNITS

Prerequisite: COSMO 35, 36, 37.
7033 lec 12:30pm - 2:00pm MT L.G. LEY E 216
& lab 2:30pm - 6:00pm MT L.G. LEY A 213
& lec 12:30pm - 2:00pm WTh L.G. LEY E 216
& lab 2:30pm - 6:00pm WTh L.G. LEY A 213
& lec 12:30pm - 2:00pm F L.G. LEY E 216
& lab 2:30pm - 6:00pm F L.G. LEY A 213
(8 Week Class - Starts 4/12/2010, Ends 6/7/2010)

COSMETOLOGY 101 INTRODUCTION TO COSMETOLOGY 3.00 UNITS

7026 lec 2:30pm - 3:55pm MTWTh R.G. LOPEZ A 208
(8 Week Class - Starts 2/8/2010, Ends 4/9/2010)

COSMETOLOGY 111 FRESHMAN COSMETOLOGY 6.00 UNITS

7000 lec 7:00am - 8:30am MTW L.H. CHEN A 208
& lab 9:00am - 2:10pm MTW L.H. CHEN A 208
& lab 7:00am - 8:30am Th L.H. CHEN A 208
& lab 9:00am - 11:00am Th L.H. CHEN A 208
& lab 11:00am - 2:10pm Th L.H. CHEN A 208
(8 Week Class - Starts 2/8/2010, Ends 4/9/2010)

7002	lec	7:00am - 8:30am	MTW	R.G. LOPEZ	A 211
&	lab	9:00am - 2:10pm	MTW	R.G. LOPEZ	A 211
&	lab	7:00am - 8:30am	Th	R.G. LOPEZ	A 211
&	lab	9:00am - 11:00am	Th	R.G. LOPEZ	A 211
&	lab	11:00am - 2:10pm	Th	R.G. LOPEZ	A 211

(8 Week Class - Starts 2/8/2010, Ends 4/9/2010)

Evening Class

4300	lec	4:30pm - 6:00pm	MT	D. MERCADO	A 208
&	lab	6:00pm - 9:30pm	MT	D. MERCADO	A 208
&	lec	4:30pm - 6:00pm	WTh	S.A. WILLIAMS	A 208
&	lab	6:00pm - 9:30pm	WTh	S.A. WILLIAMS	A 208
&	lab	7:00am - 10:00am	S	F. SMITH	A 208
&	lab	10:30am - 2:00pm	S	F. SMITH	A 208

(8 Week Class - Starts 2/8/2010, Ends 4/9/2010)

COSMETOLOGY 112 JUNIOR SALON I 6.00 UNITS

Prerequisite: Cosmetology 111.

7001	lec	7:00am - 8:30am	MTW	L.H. CHEN	A 208
&	lab	9:00am - 2:10pm	MTW	L.H. CHEN	A 208
&	lab	7:00am - 8:30am	Th	L.H. CHEN	A 208
&	lab	9:00am - 11:00am	Th	L.H. CHEN	A 208
&	lab	11:00am - 2:10pm	Th	L.H. CHEN	A 208

(8 Week Class - Starts 4/12/2010, Ends 6/7/2010)

7003	lec	7:00am - 8:30am	MTW	R.G. LOPEZ	A 211
&	lab	9:00am - 2:10pm	MTW	R.G. LOPEZ	A 211
&	lab	7:00am - 8:30am	Th	R.G. LOPEZ	A 211
&	lab	9:00am - 11:00am	Th	R.G. LOPEZ	A 211
&	lab	11:00am - 2:10pm	Th	R.G. LOPEZ	A 211

(8 Week Class - Starts 4/12/2010, Ends 6/7/2010)

Evening Class

4301	lec	4:30pm - 6:00pm	MT	D. MERCADO	A 208
&	lab	6:00pm - 9:30pm	MT	D. MERCADO	A 208
&	lec	4:30pm - 6:00pm	WTh	S.A. WILLIAMS	A 208
&	lab	6:00pm - 9:30pm	WTh	S.A. WILLIAMS	A 208
&	lab	7:00am - 10:00am	S	F. SMITH	A 208
&	lab	10:30am - 2:00pm	S	F. SMITH	A 208

(8 Week Class - Starts 4/12/2010, Ends 6/7/2010)

COSMETOLOGY 121 JUNIOR SALON II 6.00 UNITS

Prerequisite: Cosmetology 112.

7004	lec	7:00am - 8:30am	MTW	E.J. ROBINSON	A 210
&	lab	9:00am - 2:10pm	MTW	E.J. ROBINSON	A 210
&	lab	7:00am - 8:30am	Th	E.J. ROBINSON	A 210
&	lab	9:00am - 11:00am	Th	E.J. ROBINSON	A 210
&	lab	11:00am - 2:10pm	Th	E.J. ROBINSON	A 210

(8 Week Class - Starts 2/8/2010, Ends 4/9/2010)

COSMETOLOGY 122 JUNIOR SALON III 6.00 UNITS

Prerequisite: Cosmetology 121.

7005	lec	7:00am - 8:30am	MTW	E.J. ROBINSON	A 210
&	lab	9:00am - 3:10pm	MTW	E.J. ROBINSON	A 210
&	lab	7:00am - 8:30am	Th	E.J. ROBINSON	A 210
&	lab	9:00am - 11:00am	Th	E.J. ROBINSON	A 210
&	lab	11:00am - 2:10pm	Th	E.J. ROBINSON	A 210

(8 Week Class - Starts 4/12/2010, Ends 6/7/2010)

COSMETOLOGY 131 TINTING I 6.00 UNITS

Prerequisite: Cosmetology 112.

7006	lec	7:00am - 8:30am	MTW	S. SHACKELFORD	A 200
&	lab	9:00am - 2:10pm	MTW	S. SHACKELFORD	A 200
&	lab	7:00am - 8:30am	Th	S. SHACKELFORD	A 200
&	lab	9:00am - 11:00am	Th	S. SHACKELFORD	A 200
&	lab	11:00am - 2:10pm	Th	S. SHACKELFORD	A 200

(8 Week Class - Starts 2/8/2010, Ends 4/9/2010)

Evening Class

4304	lec	4:30pm - 6:00pm	MTWTh	C.P. YOUNG	A 202
&	lab	6:00pm - 9:30pm	MTWTh	C.P. YOUNG	A 202
&	lab	7:00am - 10:00am	S	C.P. YOUNG	A 202
&	lab	10:30am - 2:00pm	S	C.P. YOUNG	A 202

(8 Week Class - Starts 2/8/2010, Ends 4/9/2010)

COSMETOLOGY 132 TINTING II 6.00 UNITS

Prerequisite: Cosmetology 131.

7007	lec	7:00am - 8:30am	MTW	S. SHACKELFORD	A 200
&	lab	9:00am - 2:10pm	MTW	S. SHACKELFORD	A 200
&	lab	7:00am - 8:30am	Th	S. SHACKELFORD	A 200
&	lab	9:00am - 11:00am	Th	S. SHACKELFORD	A 200
&	lab	11:00am - 2:10pm	Th	S. SHACKELFORD	A 200

(8 Week Class - Starts 4/12/2010, Ends 6/7/2010)

Evening Class

4305	lec	4:30pm - 6:00pm	MTWTh	J.V. MONGE	A 202
&	lab	6:00pm - 9:30pm	MTWTh	J.V. MONGE	A 202
&	lab	7:00am - 10:10am	S	J.V. MONGE	A 202
&	lab	10:30am - 2:00pm	S	J.V. MONGE	A 202

(8 Week Class - Starts 4/12/2010, Ends 6/7/2010)

COSMETOLOGY 141 SENIOR SALON I 6.00 UNITS

Prerequisite: Cosmetology 122, 132.

7008	lec	7:00am - 8:30am	MTW	M.K. MAINE	A 202
&	lab	9:00am - 2:10pm	MTW	M.K. MAINE	A 202
&	lab	7:00am - 8:30am	Th	M.K. MAINE	A 202
&	lab	9:00am - 11:00am	Th	M.K. MAINE	A 202
&	lab	11:00am - 2:10pm	Th	M.K. MAINE	A 202

(8 Week Class - Starts 2/8/2010, Ends 4/9/2010)

7016	lec	2:30pm - 3:55pm	W	E.J. ROBINSON	A 210
&	lab	4:30pm - 8:00pm	W	E.J. ROBINSON	A 210
&	lab	2:30pm - 3:55pm	ThF	A.M. MYERS	A 210
&	lab	4:30pm - 8:00pm	ThF	A.M. MYERS	A 210
&	lab	2:30pm - 3:55pm	MT	R.M. NUNLEY	A 210
&	lab	4:30pm - 8:00pm	MT	R.M. NUNLEY	A 210

(8 Week Class - Starts 2/8/2010, Ends 4/9/2010)

Evening Class

4306	lec	4:30pm - 6:00pm	MTWTh	C.P. YOUNG	A 200
&	lab	6:00pm - 9:30pm	MTWTh	C.P. YOUNG	A 200
&	lab	7:00am - 10:00am	S	C.P. YOUNG	A 200
&	lab	10:30am - 2:00pm	S	C.P. YOUNG	A 200

(8 Week Class - Starts 2/8/2010, Ends 4/9/2010)

COSMETOLOGY 142 SENIOR SALON II 6.00 UNITS

Prerequisite: Cosmetology 141.

7009	lec	7:00am - 8:30am	MTW	M.K. MAINE	A 202
&	lab	9:00am - 2:10pm	MTW	M.K. MAINE	A 202
&	lab	7:00am - 8:30am	Th	M.K. MAINE	A 202
&	lab	9:00am - 11:00am	Th	M.K. MAINE	A 202
&	lab	11:00am - 2:10pm	Th	M.K. MAINE	A 202

(8 Week Class - Starts 4/12/2010, Ends 6/7/2010)

7017	lec	2:30pm - 3:55pm	W	E.J. ROBINSON	A 210
&	lab	4:30pm - 8:00pm	W	E.J. ROBINSON	A 210
&	lab	2:30pm - 3:55pm	ThF	A.M. MYERS	A 210
&	lab	4:30pm - 8:00pm	ThF	A.M. MYERS	A 210
&	lab	2:30pm - 3:55pm	MT	R.M. NUNLEY	A 210
&	lab	4:30pm - 8:00pm	MT	R.M. NUNLEY	A 210

(8 Week Class - Starts 4/12/2010, Ends 6/7/2010)

Evening Class

4307	lec	4:30pm - 6:00pm	MTWTh	J.V. MONGE	A 200
&	lab	6:00pm - 9:30pm	MTWTh	J.V. MONGE	A 200
&	lab	7:00am - 10:00am	S	J.V. MONGE	A 200
&	lab	10:30am - 2:00pm	S	J.V. MONGE	A 200

(8 Week Class - Starts 4/12/2010, Ends 6/7/2010)

CULINARY ARTS

ENGLISH 021 ENGLISH FUNDAMENTALS (NDA) 3.00 UNITS

Prerequisite: English 64.

#1180 - Culinary Arts Focus English 21 class.

1180	lec	1:30pm - 3:30pm	T	L.M. MORENO	F 235
&	lec	1:05 hrs/wk	TBA	L.M. MORENO	F 235

SPRING 2010 CLASSES

CULINARY ARTS 100 **2.00 UNITS**
INTRODUCTION TO CULINARY ARTS (CSU)

7551	lec	7:00am - 9:20am	F	J.K. KANEMAKI	H 132
&	lab	9:20am - 2:25pm	F	J.K. KANEMAKI	H 107
<i>(8 Week Class - Starts 2/8/2010, Ends 4/9/2010)</i>					
7525	lec	7:00am - 9:00am	F	J.K. KANEMAKI	H 132
&	lab	9:00am - 2:15pm	F	J.K. KANEMAKI	H 107
<i>(8 Week Class - Starts 4/16/2010, Ends 6/7/2010)</i>					

CULINARY ARTS 111 **4.00 UNITS**
CULINARY ARTS ORIENTATION I (CSU)

Pre/corequisite: Cul Art 112

7500	lec	7:00am - 8:15am	TWTh	R.T. SPENCE	H 236
&	lab	8:15am - 12:30pm	TWTh	R.T. SPENCE	H 102
<i>(8 Week Class - Starts 2/8/2010, Ends 4/9/2010)</i>					
7503	lec	7:00am - 8:15am	TWTh	R.T. SPENCE	H 236
&	lab	8:15am - 12:30pm	TWTh	R.T. SPENCE	H 102
<i>(8 Week Class - Starts 4/12/2010, Ends 6/7/2010)</i>					
7505	lec	2:00pm - 3:05pm	TTh	L.S. BLANCHARD	H 132
&	lab	3:05pm - 6:35pm	TTh	L.S. BLANCHARD	H 107
<i>(8 Week Class - Starts 2/8/2010, Ends 6/7/2010)</i>					
7530	lec	1:30pm - 2:45pm	TWTh	STAFF	H 119
&	lab	2:45pm - 7:00pm	TWTh	STAFF	H 102
<i>(8 Week Class - Starts 4/13/2010, Ends 6/7/2010)</i>					

CULINARY ARTS 112 **2.00 UNITS**
SANITATION AND SAFETY (CSU)

7501	lec	7:15am - 9:25am	MW	D. SCHERER	H 103
<i>(8 Week Class - Starts 4/12/2010, Ends 6/7/2010)</i>					
7502	lec	7:30am - 9:35am	MW	J.K. KANEMAKI	H 236
<i>(8 Week Class - Starts 2/8/2010, Ends 4/9/2010)</i>					
7504	lec	2:00pm - 4:15pm	MW	S.B. FEIGENBAUM	H 132
<i>(8 Week Class - Starts 2/8/2010, Ends 4/9/2010)</i>					
7537	lec	2:00pm - 4:15pm	MW	S.B. FEIGENBAUM	H 132
<i>(8 Week Class - Starts 4/12/2010, Ends 6/7/2010)</i>					
Evening Class					
7538	lec	4:30pm - 6:45pm	MW	S.B. FEIGENBAUM	H 103
<i>(8 Week Class - Starts 2/8/2010, Ends 4/9/2010)</i>					
7558	lec	4:30pm - 6:45pm	MW	S.B. FEIGENBAUM	H 132
<i>(8 Week Class - Starts 4/12/2010, Ends 6/7/2010)</i>					

CULINARY ARTS 120 **4.00 UNITS**
FRONT OF HOUSE/DINING SERVICES

7534	lec	9:45am - 10:45am	MTWTh	J.K. KANEMAKI	H 103
&	lab	10:45am - 2:05pm	MTWTh	J.K. KANEMAKI	H 103
<i>(8 Week Class - Starts 2/8/2010, Ends 4/9/2010)</i>					
7539	lec	9:35am - 10:35am	MTWTh	D. SCHERER	H 103
&	lab	10:35am - 1:50pm	MTWTh	D. SCHERER	H 103
<i>(8 Week Class - Starts 4/12/2010, Ends 6/7/2010)</i>					

CULINARY ARTS 121 **6.00 UNITS**
GARDE MANGER I - BAKING (CSU)

7506	lec	6:30am - 10:25am	MTWTh	L.S. BLANCHARD	H 107
&	lab	10:25am - 12:25pm	MTWTh	L.S. BLANCHARD	H 132
<i>(8 Week Class - Starts 2/8/2010, Ends 4/9/2010)</i>					
7509	lec	6:30am - 10:25am	MTWTh	L.S. BLANCHARD	H 107
&	lab	10:25am - 12:25pm	MTWTh	L.S. BLANCHARD	H 132
<i>(8 Week Class - Starts 4/12/2010, Ends 6/7/2010)</i>					
7510	lab	2:00pm - 5:35pm	TTh	D. WARRINER	H 107
&	lec	5:35pm - 7:35pm	TTh	D. WARRINER	H 119

CULINARY ARTS 122 **6.00 UNITS**
GARDE MANGER II - CHARCUTEIRE (CSU)

7507	lec	7:30am - 9:35am	MTWTh	J.A. VACHON	H 119
&	lab	9:35am - 1:25pm	MTWTh	J.A. VACHON	H 107
<i>(8 Week Class - Starts 4/12/2010, Ends 6/7/2010)</i>					
7508	lec	7:30am - 9:35am	MTWTh	J.A. VACHON	H 107
&	lab	9:35am - 1:25pm	MTWTh	J.A. VACHON	H 132
<i>(8 Week Class - Starts 2/8/2010, Ends 4/9/2010)</i>					
7511	lab	2:00pm - 5:35pm	MW	J.A. VACHON	H 119
&	lec	5:35pm - 7:35pm	MW	J.A. VACHON	H 107

CULINARY ARTS 131 **6.00 UNITS**
CULINARY ARTS - BREAKFAST I (CSU)

7512	lab	6:30am - 10:10am	MTWTh	S.B. FEIGENBAUM	H 107
&	lec	10:10am - 12:10pm	MTWTh	S.B. FEIGENBAUM	H 132
<i>(8 Week Class - Starts 2/8/2010, Ends 4/9/2010)</i>					
7515	lab	6:30am - 10:10am	MTWTh	S.B. FEIGENBAUM	H 107
&	lec	10:10am - 12:10pm	MTWTh	S.B. FEIGENBAUM	H 132
<i>(8 Week Class - Starts 4/12/2010, Ends 6/7/2010)</i>					

CULINARY ARTS 132 **6.00 UNITS**
CULINARY ARTS - BREAKFAST II (CSU)

7513	lec	7:00am - 9:00am	MTWTh	G.J. DELROSARIO	H 301
&	lab	9:00am - 12:35pm	MTWTh	G.J. DELROSARIO	H 107
<i>(8 Week Class - Starts 4/12/2010, Ends 6/7/2010)</i>					
7514	lec	7:00am - 9:00am	MTWTh	G.J. DELROSARIO	H 301
&	lab	9:00am - 12:35pm	MTWTh	G.J. DELROSARIO	H 107
<i>(8 Week Class - Starts 2/8/2010, Ends 4/9/2010)</i>					

CULINARY ARTS 141 **6.00 UNITS**
ADVANCED RESTAURANT PRACTICES I (CSU)

7518	lec	7:00am - 9:00am	MTWTh	S.L. KASMAR	H 132
&	lab	9:00am - 12:50pm	MTWTh	S.L. KASMAR	H 107
<i>(8 Week Class - Starts 2/8/2010, Ends 4/9/2010)</i>					
7519	lec	6:45am - 8:45am	MTWTh	J.K. KANEMAKI	H 132
&	lab	8:45am - 12:35pm	MTWTh	J.K. KANEMAKI	H 107
<i>(8 Week Class - Starts 4/12/2010, Ends 6/7/2010)</i>					

CULINARY ARTS 142 **6.00 UNITS**
ADVANCED RESTAURANT PRACTICES II (CSU)

7516	lab	6:45am - 10:25am	MTWTh	J.M. LISANTI	H 107
&	lec	10:25am - 12:45pm	MTWTh	J.M. LISANTI	H 107
<i>(8 Week Class - Starts 2/8/2010, Ends 4/9/2010)</i>					
7517	lab	6:45am - 10:25am	MTWTh	J.M. LISANTI	H 132
&	lec	10:25am - 12:45pm	MTWTh	J.M. LISANTI	H 334
<i>(8 Week Class - Starts 4/12/2010, Ends 6/7/2010)</i>					

CULINARY ARTS 170 **2.00 UNITS**
CULINARY NUTRITION (CSU)

7532	lec	7:00am - 9:20am	M	R.T. SPENCE	H 236
&	lec	9:20am - 2:20pm	M	R.T. SPENCE	H 102
<i>(8 Week Class - Starts 2/8/2010, Ends 4/9/2010)</i>					
7533	lec	7:00am - 9:20am	M	R.T. SPENCE	H 236
&	lec	9:20am - 2:20pm	M	R.T. SPENCE	H 102
<i>(8 Week Class - Starts 4/12/2010, Ends 6/7/2010)</i>					
7552	lec	2:30pm - 3:25pm	MW	R.T. SPENCE	H 103
&	lec	3:25pm - 5:35pm	MW	R.T. SPENCE	H 107
<i>(8 Week Class - Starts 4/12/2010, Ends 6/7/2010)</i>					

CULINARY ARTS 941 **4.00 UNITS**
COOPERATIVE EDUCATION - CULINARY ARTS

9044	lab	4:25 hrs/wk	TBA	STAFF	D 236
➤ See page 73 for details and meeting times.					

DIESEL AND RELATED TECHNOLOGY

DIESEL AND RELATED TECHNOLOGY 112 **11.00 UNITS**
DIESEL ENGINE FUNDAMENTALS

7411	lec	7:00am - 8:25am	MTWTh	C.A. ROJAS	F 100
&	lab	8:25am - 12:40pm	MTWTh	C.A. ROJAS	F 100

DIESEL AND RELATED TECHNOLOGY 122 **11.00 UNITS**
DIESEL FUEL SYSTEMS AND ELECTRIC COMPONENT THEORY

7400	lec	7:00am - 8:05am	MTWTh	J. GUERRA	F 126
&	lab	8:05am - 12:20pm	MTWTh	J. GUERRA	F 126

DIESEL AND RELATED TECHNOLOGY 132						11.00 UNITS
HEAVY DUTY DRIVE TRAIN FUNDAMENTALS						
7410	lec	7:00am - 8:05am	MTWTh	J.M. CAVANAUGH	F 100	
&	lab	8:05am - 12:20pm	MTWTh	J.M. CAVANAUGH	F 100	
DIESEL AND RELATED TECHNOLOGY 261						4.00 UNITS
CONSTRUCTION AND OPERATION OF DIESEL ENGINES						
Evening Class						
4506	lec	6:00pm - 6:30pm	MW	J.R. DROUIN	F 100	
&	lab	6:30pm - 9:35pm	MW	J.R. DROUIN	F 100	
DIESEL AND RELATED TECHNOLOGY 263						4.00 UNITS
DIESEL FUEL SYSTEMS						
4451	lec	7:30am - 10:50am	S	C.A. ROJAS	F 126	
&	lab	10:50am - 2:10pm	S	C.A. ROJAS	F 126	
DIESEL AND RELATED TECHNOLOGY 266						4.00 UNITS
DIESEL ENGINE OVERHAUL						
Evening Class						
4452	lec	6:00pm - 7:30pm	TTh	J.M. CAVANAUGH	F 100	
&	lab	7:30pm - 9:20pm	TTh	J.M. CAVANAUGH	F 100	
DIESEL AND RELATED TECHNOLOGY 941						4.00 UNITS
COOPERATIVE EDUCATION - DIESEL AND RELATED TECHNOLOGY						
9236	lec	4:25 hrs/wk	TBA	STAFF	D 236	
➤ See page 73 for details and meeting times.						

DIGITAL MEDIA

DIGITAL MEDIA 100						3.00 UNITS
INTRODUCTION TO DIGITAL VIDEO (CSU)						
Evening Class						
4361	lec	6:00pm - 7:15pm	MW	J. GUERRIERI	H 220	
&	lab	7:15pm - 8:30pm	MW	J. GUERRIERI	H 220	
DIGITAL MEDIA 103						3.00 UNITS
FUNDAMENTAL OF DIGITAL AUDIO (CSU)						
Evening Class						
4362	lec	6:00pm - 7:15pm	TTh	P. REED	H 220	
&	lab	7:15pm - 8:30pm	TTh	P. REED	H 220	

DRAFTING

DRAFTING 060						3.00 UNITS
CAD INTRODUCTION (UC:CSU)						
8004	lec	10:00am - 11:35am	F	D.E. FREELAND	D 331	
&	lab	11:35am - 3:15pm	F	D.E. FREELAND	D 331	
DRAFTING 062						3.00 UNITS
CAD FOR ARCHITECTS (CSU)						
8001	lec	9:45am - 10:50am	TTh	E.A. GARCIA	D 331	
&	lab	10:50am - 12:20pm	TTh	E.A. GARCIA	D 331	

ECONOMICS

ECONOMICS 001						3.00 UNITS
PRINCIPLES OF ECONOMICS I (UC:CSU)						
0185	lec	11:45am - 1:10pm	MW	J. AHMAD	K 321	

Evening Class						
3033	lec	6:00pm - 9:10pm	M	J. AHMAD	K 321	

Economics I is also offered through Instructional Television (ITV) Program. For registration and orientation, see Ad on page 75

ECONOMICS 002						3.00 UNITS
PRINCIPLES OF ECONOMICS II (UC:CSU)						
0186	lec	10:10am - 11:35am	MW	J. AHMAD	K 321	
0187	lec	10:10am - 11:35am	TTh	J. AHMAD	K 321	
Evening Class						
3032	lec	6:00pm - 9:10pm	T	M.D. SHAW	K 258	

EDUCATION

EDUCATION 006						1.00 UNIT
METHODS AND MATERIALS OF TUTORING						
0426	lab	3:15 hrs/wk	TBA	A.K. RANDALL	C 102	

ELECTRICAL CONSTRUCTION AND MAINTENANCE

ELECTRICAL CONSTRUCTION AND MAINTENANCE 001						3.00 UNITS
FUNDAMENTALS OF ELECTRICITY						
8330	lec	12:00pm - 1:25pm	MW	STAFF	B 301	
ELECTRICAL CONSTRUCTION AND MAINTENANCE 100						2.00 UNITS
(O.S.H.A.) SAFETY STANDARDS: CONSTRUCTION & INDUSTRY						
8130	lec	8:30am - 10:40am	W	M.D. ROGERS	TBA 1	
ELECTRICAL CONSTRUCTION AND MAINTENANCE 101						4.00 UNITS
ELECTRICAL CRAFT HELPER						
Evening Class						
4785	lec	5:30pm - 9:45pm	T	G.M. WAID	PDC DWP	
➤ Power Distribution Center, Dept of Water & Power, 11760 Truesdale, Sun Valley, CA 91352. Contact 213-763-3701						
4786	lec	5:30pm - 9:45pm	W	G.M. WAID	PDC DWP	
➤ Power Distribution Center, Dept of Water & Power, 11760 Truesdale, Sun Valley, CA 91352. Contact 213-763-3701						
4787	lec	5:30pm - 9:45pm	W	D.E. POPLAWSKI	CDH DWP	
➤ Central District Headquarters, Dept. Water & Power, 1350 S. Wall Street, Los Angeles, CA 90015. 213-763-3701						
4788	lec	5:30pm - 9:45pm	Th	D.E. POPLAWSKI	CDH DWP	
➤ Central District Headquarters, Dept. Water & Power, 1350 S. Wall Street, Los Angeles, CA 90015. 213-763-3701						
4826	lec	5:00pm - 9:15pm	Th	G.M. WAID	PDC DWP	
➤ Power Distribution Center, Dept of Water & Power, 11760 Truesdale, Sun Valley, CA 91352. Contact 213-763-3701						
5000	lec	4:30pm - 8:45pm	W	R.C. STATES	GLN PS	
➤ City of Glendale Power Station, 800 Airway, Glendale, CA 91201-3012. Contact 213-763-3707						
8324	lec	5:30pm - 9:45pm	F	D.E. POPLAWSKI	CDH DWP	
➤ Central District Headquarters, Dept. Water & Power, 1350 S. Wall Street, Los Angeles, CA 90015. 213-763-3701						
8325	lec	5:30pm - 9:45pm	F	R.E. IADEVAIA	D 301	
ELECTRICAL CONSTRUCTION AND MAINTENANCE 105						3.00 UNITS
FUNDAMENTALS OF SOLAR ELECTRICITY						
8334	lec	2:30pm - 5:40pm	F	B. GOLUZA	F 208	
Evening Class						
4750	lec	6:00pm - 9:10pm	F	B. GOLUZA	F 208	
ELECTRICAL CONSTRUCTION AND MAINTENANCE 115						3.00 UNITS
FUNDAMENTALS OF D.C. ELECTRICITY						
8122	lec	7:00am - 8:25am	TTh	D.C. BURKE	B 353	
8126	lec	7:00am - 8:25am	TTh	D.S. ROBINSON	B 301	

Evening Class						
4709	lec	6:00pm - 9:10pm	M	D.A. SUSSMAN	D 325	
4731	lec	6:00pm - 9:10pm	F	R.E. JACKSON	B 352	
ELECTRICAL CONSTRUCTION AND MAINTENANCE 116 2.00 UNITS						
HANDTOOLS AND WIRING PRACTICES						
8123	lab	7:00am - 1:30pm	F	D.C. BURKE	B 353	
8127	lab	7:00am - 1:30pm	F	D.S. ROBINSON	B 301	
Evening Class						
4712	lab	6:00pm - 9:10pm	TTh	D.C. BURKE	B 353	
4722	lab	6:00pm - 9:10pm	WF	A.C. MAH	B 353	
ELECTRICAL CONSTRUCTION AND MAINTENANCE 117 4.00 UNITS						
ELEMENTARY CIRCUIT PRACTICES						
8124	lab	8:35am - 11:45am	MTWTh	D.C. BURKE	B 353	
8128	lab	8:35am - 11:45am	MTWTh	D.S. ROBINSON	B 301	
ELECTRICAL CONSTRUCTION AND MAINTENANCE 119 3.00 UNITS						
ELECTRICAL CONSTRUCTION AND MAINTENANCE						
8125	lec	7:00am - 8:25am	MW	D.C. BURKE	B 353	
8129	lec	7:00am - 8:25am	MW	D.S. ROBINSON	B 301	
8303	lec	10:20am - 1:30pm	M	W.D. ELARTON	B 250	
ELECTRICAL CONSTRUCTION AND MAINTENANCE 120 3.00 UNITS						
INDUSTRIAL CONTROL SYSTEMS						
8136	lec	10:45am - 12:10pm	MT	J.B. LESTER	B 320	
8140	lec	9:00am - 10:25am	MT	M.D. ROGERS	B 352	
Evening Class						
4713	lec	6:00pm - 9:10pm	M	C.R. WIEGAND	B 336	
ELECTRICAL CONSTRUCTION AND MAINTENANCE 128 3.00 UNITS						
INDUSTRIAL CONTROL SYSTEMS PRACTICES						
Development and application of control circuitry.						
8137	lab	7:00am - 9:20am	MTThF	J.B. LESTER	B 320	
8141	lab	10:45am - 12:50pm	MTWThF	M.D. ROGERS	B 330	
ELECTRICAL CONSTRUCTION AND MAINTENANCE 128A 1.00 UNIT						
INDUSTRIAL CONTROL SYSTEMS PRACTICES A						
Evening Class						
4714	lab	6:00pm - 9:10pm	M	J.L. SEITZ	B 330	
4715	lab	6:00pm - 9:10pm	W	J.L. SEITZ	B 330	
ELECTRICAL CONSTRUCTION AND MAINTENANCE 128B 1.00 UNIT						
INDUSTRIAL CONTROL SYSTEMS PRACTICES B						
Evening Class						
4716	lab	6:00pm - 9:10pm	M	J.L. SEITZ	B 330	
4717	lab	6:00pm - 9:10pm	W	J.L. SEITZ	B 330	
ELECTRICAL CONSTRUCTION AND MAINTENANCE 128C 1.00 UNIT						
INDUSTRIAL CONTROL SYSTEMS PRACTICES C						
Evening Class						
4718	lab	6:00pm - 9:10pm	M	J.L. SEITZ	B 330	
4719	lab	6:00pm - 9:10pm	W	J.L. SEITZ	B 330	
ELECTRICAL CONSTRUCTION AND MAINTENANCE 129 3.00 UNITS						
FUNDAMENTALS OF ALTERNATING CURRENT						
8138	lec	10:45am - 12:10pm	ThF	J.B. LESTER	B 320	
8142	lec	9:00am - 10:25am	ThF	M.D. ROGERS	B 352	
Evening Class						
4720	lec	6:00pm - 9:10pm	T	STAFF	F 150	
4782	lec	6:00pm - 9:10pm	F	D.A. SUSSMAN	B 351	
ELECTRICAL CONSTRUCTION AND MAINTENANCE 130 3.00 UNITS						
PRINCIPLES OF INDUSTRIAL ELECTRIC POWER						
8144	lec	10:10am - 11:35am	MW	H. UCHIDA	C 201	
8149	lec	8:45am - 10:10am	MW	T.G. NIEVES	B 302	
ELECTRICAL CONSTRUCTION AND MAINTENANCE 136 3.00 UNITS						
INDUSTRIAL POWER APPLICATIONS						
8145	lab	7:00am - 10:10am	MWF	H. UCHIDA	B 304	
8150	lab	10:10am - 1:20pm	MWF	T.G. NIEVES	B 304	
ELECTRICAL CONSTRUCTION AND MAINTENANCE 137 3.00 UNITS						
INDUSTRIAL ELECTRONIC CONTROL SYSTEMS						
8146	lec	10:10am - 11:35am	TTh	H. UCHIDA	C 201	
8151	lec	8:45am - 10:10am	TTh	T.G. NIEVES	B 302	
ELECTRICAL CONSTRUCTION AND MAINTENANCE 138 2.00 UNITS						
APPLICATIONS OF ELECTRICAL AND ELECTRONICS DEVICES						
8147	lab	7:00am - 10:10am	TTh	H. UCHIDA	B 304	
8152	lab	10:10am - 1:20pm	TTh	T.G. NIEVES	B 304	
ELECTRICAL CONSTRUCTION AND MAINTENANCE 140 3.00 UNITS						
CONSTRUCTION WIRING PRINCIPLES AND PRACTICES						
8154	lec	7:00am - 8:25am	MW	R.E. JACKSON	B 336	
8159	lec	7:00am - 8:25am	MW	L.D. POGOLER	B 352	
ELECTRICAL CONSTRUCTION AND MAINTENANCE 142 1.00 UNIT						
BASIC PROGRAMMABLE LOGIC CONTROLS (PLC)						
8148	lab	11:40am - 1:05pm	TTh	H. UCHIDA	C 201	
8153	lab	7:00am - 10:10am	F	T.G. NIEVES	C 201	
ELECTRICAL CONSTRUCTION AND MAINTENANCE 150 3.00 UNITS						
INTRODUCTION TO THE ELECTRICAL CODES						
8155	lec	7:00am - 8:25am	TTh	R.E. JACKSON	B 336	
8160	lec	7:00am - 8:25am	TTh	L.D. POGOLER	B 352	
ELECTRICAL CONSTRUCTION AND MAINTENANCE 159 4.00 UNITS						
PROGRAMMABLE LOGIC CONTROLS (PLC)						
Evening Class						
4723	lec	6:00pm - 7:20pm	TTh	L.D. POGOLER	C 201	
&	lab	7:20pm - 10:40pm	TTh	L.D. POGOLER	C 201	
ELECTRICAL CONSTRUCTION AND MAINTENANCE 167 3.00 UNITS						
ELECTRICAL CONSTRUCTION WIRING TECHNIQUES						
8156	lab	8:25am - 11:35am	MWF	R.E. JACKSON	B 337	
8161	lab	8:25am - 11:35am	MWF	L.D. POGOLER	B 337	
ELECTRICAL CONSTRUCTION AND MAINTENANCE 168 2.00 UNITS						
INSTALLATION OF ELECTRICAL WIRING						
8157	lab	8:25am - 11:35am	T	R.E. JACKSON	B 337	
&	lab	7:00am - 10:10am	Th	R.E. JACKSON	B 337	
8162	lab	8:25am - 11:35am	T	L.D. POGOLER	B 337	
&	lab	7:00am - 10:10am	Th	L.D. POGOLER	B 337	
ELECTRICAL CONSTRUCTION AND MAINTENANCE 169 2.00 UNITS						
ALTERNATING CURRENT PRACTICES						
8139	lab	9:20am - 10:45am	MTThF	J.B. LESTER	B 330	
8143	lab	12:50pm - 2:00pm	MTWThF	M.D. ROGERS	B 330	
ELECTRICAL CONSTRUCTION AND MAINTENANCE 171 3.00 UNITS						
ELECTRICAL CODES AND ORDINANCES I						
Evening Class						
4724	lec	6:00pm - 9:10pm	M	R.T. TAKIGUCHI	B 320	
4760	lec	6:00pm - 9:10pm	F	J.M. DOMINGUEZ	B 301	
ELECTRICAL CONSTRUCTION AND MAINTENANCE 172 3.00 UNITS						
ELECTRICAL CODES AND ORDINANCES II						
Evening Class						
4725	lec	6:00pm - 9:10pm	M	W.D. ELARTON	B 353	
ELECTRICAL CONSTRUCTION AND MAINTENANCE 173 3.00 UNITS						
ELECTRICAL MATHEMATICS I						
Evening Class						
4726	lec	6:00pm - 9:10pm	T	N.G. KARTHAS	B 352	
ELECTRICAL CONSTRUCTION AND MAINTENANCE 174 3.00 UNITS						
ELECTRICAL MATHEMATICS II						
8307	lec	10:20am - 1:30pm	F	C.J. BARNETT	B 232	
Evening Class						
4728	lec	6:00pm - 9:10pm	M	N.G. KARTHAS	B 302	
ELECTRICAL CONSTRUCTION AND MAINTENANCE 177 3.00 UNITS						
ELECTRIC MOTOR CONTROL I						
Evening Class						
4729	lec	6:00pm - 9:10pm	M	R. WINSTON	B 352	
ELECTRICAL CONSTRUCTION AND MAINTENANCE 178 3.00 UNITS						
ELECTRIC MOTOR CONTROL II						
Evening Class						
4721	lec	6:00pm - 9:10pm	W	R. WINSTON	B 320	

ELECTRICAL CONSTRUCTION AND MAINTENANCE 181 3.00 UNITS
BASIC WIRING PRACTICES

Evening Class					
4733	lec	6:00pm - 9:10pm	T	R. RAMIREZ	B 301
4762	lec	6:00pm - 9:10pm	M	K.E. CURTIN	B 301

ELECTRICAL CONSTRUCTION AND MAINTENANCE 182 1.00 UNIT
BASIC DIAGRAM AND CIRCUIT PRACTICES

Evening Class					
4734	lab	6:00pm - 9:10pm	Th	R. RAMIREZ	B 301
4736	lab	6:00pm - 9:10pm	W	K.E. CURTIN	B 301

ELECTRICAL CONSTRUCTION AND MAINTENANCE 183 3.00 UNITS
RESIDENTIAL ELECTRIC WIRING

Evening Class					
4711	lec	6:00pm - 9:10pm	W	E.N. MAALOUF	B 352
4727	lec	6:00pm - 9:10pm	F	G.B. NASRALLAH	D 325

ELECTRICAL CONSTRUCTION AND MAINTENANCE 184 3.00 UNITS
MOTOR CONTROL PRINCIPLES AND PRACTICES

Evening Class					
4747	lec	6:00pm - 6:50pm	MW	F. BRKIC	B 304
&	lab	6:50pm - 9:00pm	MW	F. BRKIC	B 304

ELECTRICAL CONSTRUCTION AND MAINTENANCE 185 1.00 UNIT
DIRECTED STUDY - ELECTRICAL CONSTRUCTION AND MAINTENANCE

8336	lec	12:30pm - 1:20pm	F	STAFF	B 302
------	-----	------------------	---	-------	-------

ELECTRICAL CONSTRUCTION AND MAINTENANCE 186 3.00 UNITS
INDUSTRIAL ELECTRICAL PRINCIPLES AND PRACTICES

Evening Class					
4737	lec	6:00pm - 6:50pm	TTh	B. GOLUZA	B 304
&	lab	6:50pm - 9:10pm	TTh	B. GOLUZA	B 304

ELECTRICAL CONSTRUCTION AND MAINTENANCE 193 3.00 UNITS
CONDUIT BENDING AND CALCULATIONS

Evening Class					
4773	lec	6:00pm - 6:45pm	TTh	R.E. JACKSON	B 337
&	lab	6:45pm - 9:10pm	TTh	R.E. JACKSON	B 337

ELECTRICAL CONSTRUCTION AND MAINTENANCE 193A 1.00 UNIT
CONDUIT BENDING LABORATORY

8158	lab	10:10am - 1:20pm	Th	R.E. JACKSON	B 337
8163	lab	10:10am - 1:20pm	Th	L.D. POGOLER	B 337

ELECTRICAL CONSTRUCTION AND MAINTENANCE 195 3.00 UNITS
GROUNDING: FUNDAMENTALS, APPLICATIONS AND PRACTICES

4770	lec	8:00am - 11:10am	S	M.D. ROGERS	B 352
------	-----	------------------	---	-------------	-------

ELECTRICAL CONSTRUCTION AND MAINTENANCE 196 4.00 UNITS
INFRASTRUCTURE WIRING PRACTICES

Evening Class					
4758	lec	6:00pm - 7:05pm	TTh	M. ZELAYA	B 351
&	lab	7:05pm - 9:40pm	TTh	M. ZELAYA	B 351

ELECTRICAL CONSTRUCTION AND MAINTENANCE 197 3.00 UNITS
LOW VOLTAGE ELECTRICAL PRACTICES

Evening Class					
4707	lec	6:00pm - 6:50pm	MW	D.S. ROBINSON	B 351
&	lab	6:50pm - 9:10pm	MW	D.S. ROBINSON	B 351

ELECTRICAL CONSTRUCTION AND MAINTENANCE 199 3.00 UNITS
JOURNEYMAN ELECTRICIAN EXAM PREPARATION

Evening Class					
4735	lec	6:00pm - 6:40pm	TTh	W.D. ELARTON	F 208
Team	lab	6:00pm - 9:10pm	Th	D.S. ROBINSON/W.D. ELARTON	B 352

ELECTRICAL CONSTRUCTION AND MAINTENANCE 205 2.00 UNITS
SOLAR ENERGY INSTALLATION & MAINTENANCE PRINCIPLES AND PRACTICES

8335	lab	2:30pm - 5:40pm	MW	B. GOLUZA	F 151
Evening Class					
8526	lab	6:00pm - 8:50pm	MW	B. GOLUZA	F 151

ELECTRICAL CONSTRUCTION AND MAINTENANCE 941 4.00 UNITS
COOPERATIVE EDUCATION -ELECTRICAL CONSTRUCTION & MAINTENANCE

9072	lec	4:25 hrs/wk	TBA	STAFF	D 236
------	-----	-------------	-----	-------	-------

> See page 73 for details and meeting times.

ELECTRICAL LINEMAN

ELECTRICAL LINEMAN 600 15.00 Units
ELECTRIC UTILITY LINE-WORKER (600 Hours)

8320	lec	7:00am - 8:10am	MTWThF	K.L. BUSHMAN	F 208
&	lab	8:10am - 2:30pm	MTWThF	K.L. BUSHMAN	F 208

ELECTRONICS

ELECTRONICS 002 3.00 UNITS
INTRODUCTION TO ELECTRONICS (CSU)

0461	lec	10:10am - 1:20pm	W	S.A. ROOSTA	E 306
3330	lec	1:00pm - 4:10pm	W	R.W. CAMPBELL	E 306

Evening Class					
3331	lec	6:00pm - 9:10pm	W	R.W. CAMPBELL	E 306

ELECTRONICS TECHNOLOGY

ELECTRONICS TECHNOLOGY 154 3.00 UNITS
AC THEORY AND CIRCUIT FUNDAMENTALS

0476	lec	7:00am - 8:25am	T	S.A. ROOSTA	E 302
&	lec	8:35am - 10:00am	TTh	S.A. ROOSTA	E 302

ELECTRONICS TECHNOLOGY 155 2.00 UNITS
AC THEORY AND CIRCUIT FUNDAMENTALS LAB

0479	lab	8:35am - 11:50am	T	S.A. ROOSTA	E 305
&	lab	10:10am - 1:15pm	Th	S.A. ROOSTA	E 305

ELECTRONICS TECHNOLOGY 156 1.00 UNIT
APPLIED AC CALCULATIONS

0482	lec	7:00am - 7:50am	Th	S.A. ROOSTA	E 302
------	-----	-----------------	----	-------------	-------

ELECTRONICS TECHNOLOGY 157 3.00 UNITS
SEMICONDUCTORS DEVICES AND APPLICATIONS (UC:CSU)

0485	lec	7:00am - 8:25am	TTh	S. CYRUS	E 301
------	-----	-----------------	-----	----------	-------

ELECTRONICS TECHNOLOGY 158 3.00 UNITS
SEMICONDUCTORS DEVICES AND ELECTRONICS LABORATORY (UC:CSU)

0488	lab	10:30am - 2:45pm	TTh	S. CYRUS	E 301
------	-----	------------------	-----	----------	-------

ELECTRONICS TECHNOLOGY 159 3.00 UNITS
DIGITAL CIRCUITS AND APPLICATIONS (UC:CSU)

0491	lec	8:35am - 10:10am	TTh	S. CYRUS	E 301
------	-----	------------------	-----	----------	-------

ELECTRONICS TECHNOLOGY 160 2.00 UNITS
DIGITAL CIRCUITS AND APPLICATIONS LAB (UC:CSU)

0494	lab	10:10am - 1:00pm	TTh	S. CYRUS	E 301
------	-----	------------------	-----	----------	-------

ELECTRONICS TECHNOLOGY 161 3.00 UNITS
F.C.C. RADIO OPERATOR LICENSE (UC:CSU)

7832	lec	2:40 hrs/wk	TBA	E.L. CHAVEZ	E 200
------	-----	-------------	-----	-------------	-------

**ELECTRONICS TECHNOLOGY 252
NETWORK CABLING SPECIALIST** **3.00 UNITS**

0509	lec	7:00am - 9:05am	F	S. CYRUS	E 304
&	lab	9:25am - 12:35pm	F	S. CYRUS	E 304

**ELECTRONICS TECHNOLOGY 253
FIBER OPTICS** **3.00 UNITS**

0512	lec	7:00am - 9:05am	M	S. CYRUS	E 301
&	lab	9:25am - 12:35pm	M	S. CYRUS	E 301

**ELECTRONICS TECHNOLOGY 254
COMPUTER APPLICATIONS FOR ELECTRONICS TECHNOLOGY** **3.00 UNITS**

0515	lec	7:00am - 9:05am	M	S.A. ROOSTA	E 200
&	lab	9:25am - 12:35pm	M	S.A. ROOSTA	E 200

**ELECTRONICS TECHNOLOGY 255
COMPUTER-BASED ELECTRONICS I** **1.00 UNIT**

0518	lab	7:00am - 10:10am	W	S.A. ROOSTA	E 200
------	-----	------------------	---	-------------	-------

**ENGINEER-OPERATION
MAINTENANCE****ENGINEER-OPERATION MAINTENANCE 228
STEAM PLANT OPERATION I** **6.00 UNITS**

Evening Class					
4755	lec	6:00pm - 9:10pm	MW	V. MARTINOV	F 208

**ENGINEER-OPERATION MAINTENANCE 229
STEAM PLANT OPERATION II** **6.00 UNITS**

Evening Class					
4756	lec	6:00pm - 9:10pm	TTh	P.A. BRADY	B 320

**ENGINEER-OPERATION MAINTENANCE 941
COOPERATIVE EDUCATION - ENGINEER-OPERATION MAINTENANCE** **4.00 UNITS**

9148	lec	4:25 hrs/wk	TBA	STAFF	D 236
------	-----	-------------	-----	-------	-------

> See page 73 for details and meeting times.

ENGINEERING, GENERAL**ENGINEERING, GENERAL 101
INTRODUCTION TO SCIENCE, ENGINEERING AND TECHNOLOGY (UC:CSU)** **2.00 UNITS**

1690	lec	7:00am - 8:05am	MW	M.A. EL TAWANSY	K 422
------	-----	-----------------	----	-----------------	-------

**ENGINEERING, GENERAL 110
ENGINEERING GRAPHICS (UC:CSU)** **3.00 UNITS**

1691	lec	10:10am - 11:15am	T	M.A. EL TAWANSY	D 331
&	lab	11:15am - 12:20pm	T	M.A. EL TAWANSY	D 331
&	lab	10:10am - 12:20pm	Th	M.A. EL TAWANSY	D 331

ENGLISH**ENGLISH 021
ENGLISH FUNDAMENTALS (NDA)** **3.00 UNITS**

Prerequisite: English 64.					
1101	lec	11:45am - 1:10pm	TTh	R.N. SHAKIR	F 234
1102	lec	10:10am - 11:35am	TTh	G.P. MCCANTS	F 224
1103	lec	10:10am - 11:35am	MW	T.M. DOLAN	F 228
1158	lec	8:00am - 11:10am	F	S.V. MITCHELL	F 216

1161	lec	12:45pm - 2:10pm	MW	T.M. DOLAN	F 228
1162	lec	8:35am - 10:00am	MW	R.A. MANCIA	F 234
1165	lec	8:35am - 10:00am	TTh	R.A. MANCIA	F 234
1167	lec	10:10am - 11:35am	TTh	H.M. DOSS	F 229
1179	lec	8:35am - 10:00am	MW	R.M. DALRYMPLE	F 235

#1180 - Culinary Arts Focus English 21 class.					
1180	lec	1:30pm - 3:30pm	T	L.M. MORENO	F 235
&	lec	1:05 hrs/wk	TBA	L.M. MORENO	F 235
1181	lec	10:10am - 11:35am	MW	R.N. SHAKIR	F 216

Evening Class					
3701	lec	6:00pm - 9:10pm	M	A.A. STEVENS	K 222
3702	lec	6:00pm - 9:10pm	T	A.A. STEVENS	K 222
3703	lec	6:00pm - 9:10pm	W	G.P. MCCANTS	F 224
3704	lec	6:00pm - 9:10pm	Th	L.I. FOSTER	F 231

Fashion Focus English 28
#1177
Instructor: Lisa Moreno
Wednesdays
11:45 - 1:45 + 1 hr. TBA
Room F-223

Additional information at lisamoreno.net

**ENGLISH 028
INTERMEDIATE READING AND COMPOSITION** **3.00 UNITS**

Prerequisite: English 21.					
1170	lec	10:10am - 11:35am	TTh	T.M. DOLAN	F 228
1172	lec	8:35am - 10:10am	MW	A. DURAN	F 231
1173	lec	10:10am - 11:35am	MW	L.A. STAHL	F 224
1174	lec	10:10am - 11:35am	MW	R.M. DALRYMPLE	F 235
1175	lec	8:35am - 10:00am	TTh	M.A. GONZALEZ	K 222
1176	lec	10:10am - 11:35am	TTh	M.A. GONZALEZ	F 231
1207	lec	10:10am - 11:35am	TTh	E.A. GREGORY	K 222
1559	lec	11:45am - 1:10pm	MW	R.A. MANCIA	F 234

#1177 - Fashion Focus English 28 class.					
1177	lec	11:45am - 1:45pm	W	L.M. MORENO	F 223
&	lec	1:00 hrs/wk	TBA	L.M. MORENO	F 223
7946	lec	3:15 hrs/wk	TBA	J.M. GANGEL VASQUEZ	ON LINE

> Please visit the online program homepage at <http://moodle.lattc.edu> prior to the start of class for directions, or see pages 70-72 of this schedule for more information.

Evening Class					
3706	lec	6:00pm - 9:10pm	T	M.A. KOBLER	F 216
3707	lec	6:00pm - 9:10pm	W	F.J. VILLANI	F 227
3708	lec	6:00pm - 9:10pm	Th	F.J. VILLANI	F 216

**ENGLISH 047
READING CLINIC (NDA)** **3.00 UNITS**

1188	lec	7:00am - 8:30am	TTh	D.S. SMITH	F 216
------	-----	-----------------	-----	------------	-------

**ENGLISH 064
INTERMEDIATE READING AND COMPOSITION: BASIC SKILLS (NDA)** **3.00 UNITS**

1186	lec	11:45am - 1:10pm	MW	F.E. LENNON	F 224
1410	lec	11:45am - 1:10pm	TTh	A.E. MENDEZ	F 216

Evening Class					
3710	lec	6:00pm - 9:10pm	Th	E.F. MENZIES	F 224
3711	lec	6:00pm - 9:10pm	T	E.F. MENZIES	F 224
3712	lec	6:00pm - 9:10pm	W	J.C. DANIELS	F 234

**ENGLISH 101
COLLEGE READING AND COMPOSITION I (UC:CSU)** **3.00 UNITS**

Prerequisite: English 28.					
1107	lec	10:10am - 11:35am	TTh	A.E. MENDEZ	F 214
1108	lec	10:10am - 11:35am	TTh	R.A. MANCIA	F 216
1109	lec	8:35am - 10:10am	TTh	R.N. SHAKIR	F 216
1110	lec	11:45am - 1:10pm	TTh	R.M. DALRYMPLE	F 224
1111	lec	8:35am - 10:00am	MW	M.A. GONZALEZ	K 222
1196	lec	11:45am - 1:10pm	MW	R.N. SHAKIR	F 216
1199	lec	10:10am - 11:35am	MW	R.A. MANCIA	F 234
#1571 - Honor class					
1571	lec	10:10am - 11:35am	MW	R.A. MANCIA	F 234

7947	lec	3:15 hrs/wk	TBA	L.M. MORENO	ON LINE
➤ Please visit the online program homepage at http://moodle.lattc.edu prior to the start of class for directions, or see pages 70-72 of this schedule for more information.					
Evening Class					
3716	lec	6:00pm - 9:10pm	W	M.A. KOBLER	F 229
3736	lec	6:00pm - 9:10pm	W	B.L. JACOBS	F 210
#4021 - Honor class					
4021	lec	6:00pm - 9:10pm	W	B.L. JACOBS	F 223

English 101 is also offered through Instructional Television (ITV) Program. For registration and orientation, see Ad on page 75

ENGLISH 102					
COLLEGE READING AND COMPOSITION II (UC:CSU)					
Prerequisite: English 101.					
1113	lec	11:45am - 1:10pm	TTh	T.M. DOLAN	F 228
#1572 - Honor class					
1572	lec	11:45am - 1:10pm	TTh	T.M. DOLAN	F 228
7948	lec	3:15 hrs/wk	TBA	J.M. GANGEL VASQUEZ	ON LINE
➤ Please visit the online program homepage at http://moodle.lattc.edu prior to the start of class for directions, or see pages 70-72 of this schedule for more information.					

English 102 is also offered through Instructional Television (ITV) Program. For registration and orientation, see Ad on page 75

ENGLISH 103					
COMPOSITION AND CRITICAL THINKING (UC:CSU)					
Prerequisite: English 101.					
1115	lec	10:10am - 11:35am	MW	M.A. GONZALEZ	K 222
1117	lec	2:15pm - 3:40pm	MW	T.M. DOLAN	F 228
1118	lec	10:10am - 11:35am	TTh	G.B. BLAKE	F 223
7943	lec	3:15 hrs/wk	TBA	L.M. MORENO	ON LINE
➤ Please visit the online program homepage at http://moodle.lattc.edu prior to the start of class for directions, or see pages 70-72 of this schedule for more information.					
Evening Class					
3731	lec	6:00pm - 9:10pm	T	W.L. RYDER	F 215
3832	lec	6:00pm - 9:10pm	Th	A.A. AHMED	F 234
#4023 - Honor class					
4023	lec	6:00pm - 9:10pm	Th	A.A. AHMED	F 234

ENGLISH 127					
CREATIVE WRITING (CSU)					
1574	lec	10:10am - 11:35am	TTh	R.N. SHAKIR	F 234

ENGLISH 206					
ENGLISH LITERATURE II (UC:CSU)					
Prerequisite: English 101.					
7942	lec	3:15 hrs/wk	TBA	L.M. MORENO	ON LINE
➤ Please visit the online program homepage at http://moodle.lattc.edu prior to the start of class for directions, or see pages 70-72 of this schedule for more information.					

ENGLISH AS A SECOND LANGUAGE

ENGLISH AS A SECOND LANGUAGE 004A					
COLLEGE ENGLISH AS A SECOND LANGUAGE IV: READING AND VOCABULARY					
Prerequisite: ESL 3A					
0887	lec	10:10am - 11:35am	MTWTh	D. GRUNBAUM	E 214
ENGLISH AS A SECOND LANGUAGE 005A					
COLLEGE ENGLISH AS A SECOND LANGUAGE V: WRITING AND GRAMMAR (CSU)					
Prerequisite: ESL 4A					
0889	lec	10:10am - 11:35am	MTWTh	K.C. KINYON	E 101
ENGLISH AS A SECOND LANGUAGE 005B					
COLLEGE ENGLISH AS A SECOND LANGUAGE V: READING AND VOCABULARY					
Prerequisite: ESL 4B					
0890	lec	8:35am - 10:10am	TTh	K.C. KINYON	E 101

ENGLISH AS A SECOND LANGUAGE 006A

COLLEGE ENGLISH AS A SECOND LANGUAGE VI: WRITING AND GRAMMAR (CSU)

Prerequisite: ESL 5A with a grade of "C" or better.					
0891	lec	10:10am - 11:35am	MTWTh	V.F. LE VEQUE	E 209
0892	lec	8:35am - 10:10am	TTh	N.N. DE LA PENNA	E 209

English as a Second Language Course Sequence

Trade-Tech offers a complete English as a Second Language package, all the way from ESL 1, for complete beginners, to ESL 8, which leads into English 101.

English learners can improve their skills in writing and grammar (the ESL "A" classes), reading and vocabulary (the "B" classes), and listening and speaking (the "C" classes).

The units from core ESL classes above level 2 not only apply towards the community college degree, but also earn transfer credit.

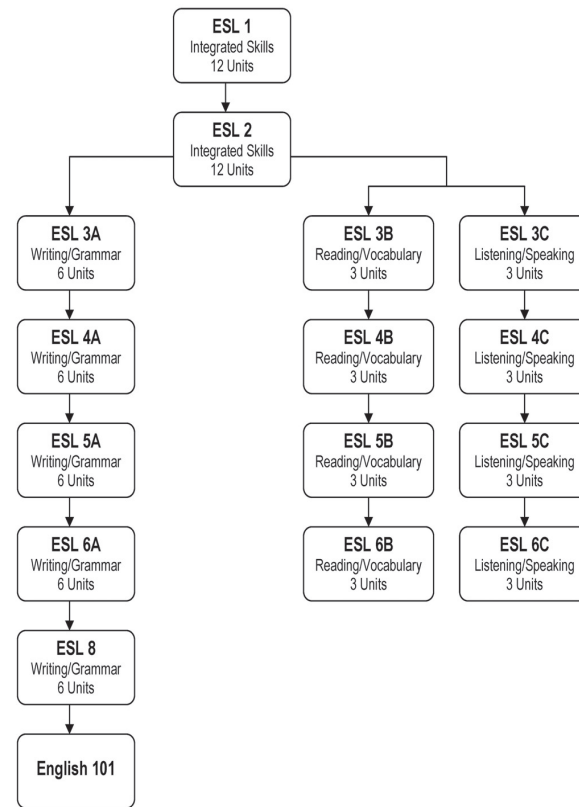

SPRING 2010 CLASSES

ENVIRONMENTAL SCIENCE

ENVIRONMENTAL SCIENCE 001					
THE HUMAN ENVIRONMENT: PHYSICAL PROCESSES (UC:CSU)					
Prerequisite: ESL 4A					
7828	lec	3:30 hrs/wk	TBA	R.E. PIEPER	ON LINE
<i>(15 Week Class - Starts 3/1/2010, Ends 6/7/2010)</i>					
➤ Please visit the online program homepage at http://moodle.lattc.edu prior to the start of class for directions, or see pages 70-72 of this schedule for more information.					

FASHION DESIGN

ENGLISH 028 3.00 UNITS

INTERMEDIATE READING AND COMPOSITION

Prerequisite: English 21.

#1177 - Fashion Focus English 28 class.

1177	lec	11:45am - 1:45pm	W	L.M. MORENO	F 223
&	lec	1:00 hrs/wk	TBA	L.M. MORENO	F 223

Fashion Focus English 28
#1177
Instructor: Lisa Moreno
Wednesdays
11:45 - 1:45 + 1 hr. TBA
Room F-223
 Additional information at lisamoreno.net

FASHION DESIGN 101 2.00 UNITS

INTRODUCTION TO FASHION DESIGN

7133	lec	8:35am - 9:35am	S	C. ALCALA	D 234
&	lab	9:35am - 3:15pm	S	C. ALCALA	D 234
<i>(8 Week Class - Starts 2/8/2010, Ends 4/9/2010)</i>					

FASHION DESIGN 111 4.00 UNITS

CLOTHING CONSTRUCTION (CSU)

7050	lec	7:00am - 8:00am	MTWThF	C.R. WATANABE	D 234
&	lab	8:00am - 11:10am	MTWThF	C.R. WATANABE	D 234
<i>(8 Week Class - Starts 2/8/2010, Ends 4/9/2010)</i>					
7051	lec	7:00am - 8:00am	MTWThF	T.R. JACKSON	D 332
&	lab	8:00am - 11:10am	MTWThF	T.R. JACKSON	D 332
<i>(8 Week Class - Starts 2/8/2010, Ends 4/9/2010)</i>					
7052	lec	11:50am - 12:50pm	MTWThF	STAFF	D 234
&	lab	12:50pm - 4:00pm	MTWThF	STAFF	D 234
<i>(8 Week Class - Starts 2/8/2010, Ends 4/9/2010)</i>					
7053	lec	7:00am - 8:00am	MTWThF	A.D. LEE	D 234
&	lab	8:00am - 11:10am	MTWThF	A.D. LEE	D 234
<i>(8 Week Class - Starts 4/12/2010, Ends 6/7/2010)</i>					
7054	lec	11:50am - 12:50pm	MTWThF	N. GLASS VILLALOBOS	D 234
&	lab	12:50pm - 4:00pm	MTWThF	N. GLASS VILLALOBOS	D 234
<i>(8 Week Class - Starts 4/12/2010, Ends 6/7/2010)</i>					

FASHION DESIGN 112 4.00 UNITS

BASIC FASHION ART AND DESIGN (CSU)

7055	lec	7:00am - 8:00am	MTWThF	M.K. BRAND NJOKU	D 230
&	lab	8:00am - 11:10am	MTWThF	M.K. BRAND NJOKU	D 230
<i>(8 Week Class - Starts 2/8/2010, Ends 4/9/2010)</i>					
7056	lec	11:50am - 12:50pm	MTWThF	M.B. COREAS	D 230
&	lab	12:50pm - 4:00pm	MTWThF	M.B. COREAS	D 230
<i>(8 Week Class - Starts 2/8/2010, Ends 4/9/2010)</i>					
7057	lec	7:00am - 8:00am	MTWThF	M.K. BRAND NJOKU	D 230
&	lab	8:00am - 11:10am	MTWThF	M.K. BRAND NJOKU	D 230
<i>(8 Week Class - Starts 4/12/2010, Ends 6/7/2010)</i>					
7058	lec	7:00am - 8:00am	MTWThF	C.R. WATANABE	D 105
&	lab	8:00am - 11:10am	MTWThF	C.R. WATANABE	D 105
<i>(8 Week Class - Starts 4/12/2010, Ends 6/7/2010)</i>					
7059	lec	11:50am - 12:50pm	MTWThF	STAFF	D 205
&	lab	12:50pm - 4:00pm	MTWThF	STAFF	D 205
<i>(8 Week Class - Starts 4/12/2010, Ends 6/7/2010)</i>					

FASHION DESIGN 118 2.00 UNITS

ADVANCED CLOTHING CONSTRUCTION

Prerequisite: Fashion Design 111

7061	lec	12:00pm - 1:00pm	F	A.D. LEE	D 332
&	lab	1:00pm - 4:30pm	F	A.D. LEE	D 332

FASHION DESIGN 119 3.00 UNITS

HISTORY OF COSTUME

7062	lec	12:00pm - 1:45pm	TTh	T.R. JACKSON	D 236
------	-----	------------------	-----	--------------	-------

FASHION DESIGN 120 4.00 UNITS

BASIC PATTERN MAKING & DESIGN (CSU)

Prerequisite: Fashion Design 111 & 112

7064	lec	7:00am - 8:00am	MTWThF	T.R. JACKSON	D 332
&	lab	8:00am - 11:10am	MTWThF	T.R. JACKSON	D 332
<i>(8 Week Class - Starts 4/12/2010, Ends 6/7/2010)</i>					
7065	lec	7:00am - 8:00am	MTWThF	STAFF	D 205
&	lab	8:00am - 11:10am	MTWThF	STAFF	D 205
<i>(8 Week Class - Starts 4/12/2010, Ends 6/7/2010)</i>					
7066	lec	11:50am - 12:50pm	MTWThF	C.M. IAFFALDANO	D 105
&	lab	12:50pm - 4:00pm	MTWThF	C.M. IAFFALDANO	D 105
<i>(8 Week Class - Starts 4/12/2010, Ends 6/7/2010)</i>					

FASHION DESIGN 122 4.00 UNITS

GRADING AND MARKER MAKING

7068	lec	7:00am - 8:00am	MTWThF	C.E. SAPOS	D 105
&	lab	8:00am - 11:10am	MTWThF	C.E. SAPOS	D 105
<i>(8 Week Class - Starts 2/8/2010, Ends 4/9/2010)</i>					
7069	lec	7:00am - 8:00am	MTWThF	STAFF	D 205
&	lab	8:00am - 11:10am	MTWThF	STAFF	D 205
<i>(8 Week Class - Starts 2/8/2010, Ends 4/9/2010)</i>					
7070	lec	11:50am - 12:50pm	MTWThF	N. GLASS VILLALOBOS	D 205
&	lab	12:50pm - 4:00pm	MTWThF	N. GLASS VILLALOBOS	D 205
<i>(8 Week Class - Starts 2/8/2010, Ends 4/9/2010)</i>					

FASHION DESIGN 125 3.00 UNITS

TEXTILES, FIBERS AND FABRICS, PROPERTIES AND MANUFACTURING (CSU)

7073	lec	9:00am - 10:45am	MW	C.M. IAFFALDANO	D 236
------	-----	------------------	----	-----------------	-------

FASHION DESIGN 130 4.00 UNITS

DRAPING & DESIGN (CSU)

Prerequisite: Fashion Design 111, 112, 120 & 122

7076	lec	7:00am - 8:00am	MTWThF	C.E. SAPOS	D 205
&	lab	8:00am - 11:10am	MTWThF	C.E. SAPOS	D 205
<i>(8 Week Class - Starts 4/12/2010, Ends 6/7/2010)</i>					
7077	lec	7:00am - 8:00am	MTWThF	H. KIM	D 102
&	lab	8:00am - 11:10am	MTWThF	H. KIM	D 102
<i>(8 Week Class - Starts 4/12/2010, Ends 6/7/2010)</i>					
7078	lec	11:50am - 12:50pm	MTWThF	M.B. COREAS	D 230
&	lab	12:50pm - 4:00pm	MTWThF	M.B. COREAS	D 230
<i>(8 Week Class - Starts 4/12/2010, Ends 6/7/2010)</i>					

FASHION DESIGN 132 4.00 UNITS

ADVANCED PATTERNS AND DESIGN (CSU)

Prerequisite: Fashion Design 111, 112, 120 & 122

7080	lec	7:00am - 8:00am	MTWThF	A.D. LEE	D 332
&	lab	8:00am - 11:10am	MTWThF	A.D. LEE	D 332
<i>(8 Week Class - Starts 2/8/2010, Ends 4/9/2010)</i>					
7081	lec	7:00am - 8:00am	MTWThF	H. KIM	D 102
&	lab	8:00am - 11:10am	MTWThF	H. KIM	D 102
<i>(8 Week Class - Starts 2/8/2010, Ends 4/9/2010)</i>					
7082	lec	11:50am - 12:50pm	MTWThF	C.M. IAFFALDANO	D 105
&	lab	12:50pm - 4:00pm	MTWThF	C.M. IAFFALDANO	D 105
<i>(8 Week Class - Starts 2/8/2010, Ends 4/9/2010)</i>					

FASHION DESIGN 139 2.00 UNITS

COORDINATED SPORTSWEAR (CSU)

Prerequisites: FASHDSN 132

Evening Class					
4272	lec	6:00pm - 6:30pm	TTh	STAFF	D 106
&	lab	6:30pm - 8:05pm	TTh	STAFF	D 106

FASHION DESIGN 140 2.00 UNITS
ADVANCED DRAPING & DESIGN

Prerequisites: FASHDSN 130 or 239.
 7084 lec 11:45am - 12:45pm MW H. KIM D 102
 & lab 12:45pm - 3:05pm MW H. KIM D 102
(8 Week Class - Starts 4/12/2010, Ends 6/7/2010)

FASHION DESIGN 141 4.00 UNITS
ADVANCED DESIGN (CSU)

Prerequisites: FASHDSN 111, 112, 120, 122, 130, 132.
 7085 lec 7:00am - 8:00am MTWThF F. DREBSKAYA D 130
 & lab 8:00am - 11:10am MTWThF F. DREBSKAYA D 130
(8 Week Class - Starts 2/8/2010, Ends 4/9/2010)
 7086 lec 7:00am - 8:00am MTWThF D.M. THORNTON D 106
 & lab 8:00am - 11:10am MTWThF D.M. THORNTON D 106
(8 Week Class - Starts 2/8/2010, Ends 4/9/2010)

FASHION DESIGN 142 4.00 UNITS
MANUFACTURING PRODUCTION (CSU)

Prerequisites: FASHDSN 111, 112, 120, 122, 130, 132, 141.
 7089 lec 7:00am - 8:00am MTWThF F. DREBSKAYA D 130
 & lab 8:00am - 11:10am MTWThF F. DREBSKAYA D 130
(8 Week Class - Starts 4/12/2010, Ends 6/7/2010)
 7090 lec 7:00am - 8:00am MTWThF D.M. THORNTON D 106
 & lab 8:00am - 11:10am MTWThF D.M. THORNTON D 106
(8 Week Class - Starts 4/12/2010, Ends 6/7/2010)

FASHION DESIGN 147 2.00 UNITS
DEVELOPING A FASHION SHOW

7116 lec 12:00pm - 1:30pm F C.L. ANDERSON D 236
 & lab 1:00 hrs/wk TBA C.L. ANDERSON D 236

FASHION DESIGN 148 2.00 UNITS
ACTIVEWEAR DESIGN

Prerequisites: FASHDSN 132 or 225.
 7134 lec 8:35am - 9:35am S L.A. MELIN D 102
 & lab 9:35am - 3:15pm S L.A. MELIN D 102
(8 Week Class - Starts 4/12/2010, Ends 6/7/2010)

FASHION DESIGN 222 2.00 UNITS
SAMPLE MAKING AND DESIGN I

7101 lab 8:35am - 3:05pm S F. DREBSKAYA D 130
 Evening Class
 4250 lab 6:00pm - 9:10pm TTh B.S. TORDA D 234

FASHION DESIGN 223 2.00 UNITS
SAMPLE MAKING AND DESIGN II

7103 lab 8:35am - 3:05pm S F. DREBSKAYA D 130
 Evening Class
 4251 lab 6:00pm - 9:10pm TTh B.S. TORDA D 234

FASHION DESIGN 224 2.00 UNITS
SAMPLE MAKING AND DESIGN III

7105 lab 8:35am - 3:05pm S F. DREBSKAYA D 130
 Evening Class
 4252 lab 6:00pm - 9:10pm TTh B.S. TORDA D 234

FASHION DESIGN 225 2.00 UNITS
PATTERN MAKING AND DESIGN I

Evening Class
 4253 lab 6:00pm - 9:10pm MW D.J. FORAL D 130

FASHION DESIGN 226 2.00 UNITS
PATTERN MAKING AND DESIGN II

7109 lab 8:35am - 3:05pm S W. STAFFORD D 205
 Evening Class
 4254 lab 6:00pm - 9:10pm MW L.A. MELIN D 332

FASHION DESIGN 227 2.00 UNITS
PATTERN MAKING AND DESIGN III

7111 lab 8:35am - 3:05pm S W. STAFFORD D 205
 Evening Class
 4255 lab 6:00pm - 9:10pm MW L.A. MELIN D 332

FASHION DESIGN 228 2.00 UNITS
PATTERN GRADING AND DESIGN I

Evening Class
 4256 lab 6:00pm - 9:10pm TTh N. GLASS VILLALOBOS D 106

FASHION DESIGN 229 2.00 UNITS
PATTERN GRADING AND DESIGN II

Evening Class
 4257 lab 6:00pm - 9:10pm TTh N. GLASS VILLALOBOS D 106

FASHION DESIGN 230 1.00 UNIT
CONTEMPORARY GARMENT CONSTRUCTION TECHNIQUES

7091 lab 1:00pm - 3:00pm MW F. DREBSKAYA D 130
(16 Week Class - Starts 2/15/2010, Ends 6/7/2010)
 Evening Class
 4282 lab 4:00pm - 6:00pm TTh D.M. THORNTON D 106
(16 Week Class - Starts 2/15/2010, Ends 6/7/2010)

FASHION DESIGN 231 1.00 UNIT
CONTEMPORARY PATTERN MAKING TECHNIQUES

7098 lab 1:00pm - 3:00pm MW F. DREBSKAYA D 130
(16 Week Class - Starts 2/15/2010, Ends 6/7/2010)
 Evening Class
 4283 lab 4:00pm - 6:00pm TTh D.M. THORNTON D 106
(16 Week Class - Starts 2/15/2010, Ends 6/7/2010)

FASHION DESIGN 236 2.00 UNITS
FASHION SKETCHING AND DESIGN I

Evening Class
 4260 lab 6:00pm - 9:10pm MW C.R. WATANABE D 230

FASHION DESIGN 237 2.00 UNITS
FASHION SKETCHING AND DESIGN II

Evening Class
 4262 lab 6:00pm - 9:10pm MW C.R. WATANABE D 230

FASHION DESIGN 238 2.00 UNITS
FASHION SKETCHING AND DESIGN III

Evening Class
 4264 lab 6:00pm - 9:10pm MW C.R. WATANABE D 230

FASHION DESIGN 239 2.00 UNITS
GOWN DRAPING AND DESIGN I

7120 lab 8:35am - 3:05pm S D.J. CUNNIGAN D 105
 Evening Class
 4267 lab 6:00pm - 9:10pm TTh H. KIM D 102

FASHION DESIGN 240 2.00 UNITS
GOWN DRAPING AND DESIGN II

7121 lab 8:35am - 3:05pm S D.J. CUNNIGAN D 105
 Evening Class
 4269 lab 6:00pm - 9:10pm TTh H. KIM D 102

FASHION DESIGN 241 2.00 UNITS
GOWN DRAPING AND DESIGN III

7122 lab 8:35am - 3:05pm S D.J. CUNNIGAN D 105
 Evening Class
 4271 lab 6:00pm - 9:10pm TTh H. KIM D 102

FASHION DESIGN 244 2.00 UNITS
COMPUTER FASHION ART

7123 lab 8:35am - 3:05pm S L.L. ADAMS D 203

FASHION DESIGN 250 2.00 UNITS
BEGINNING COMPUTER APPAREL SYSTEMS

Evening Class
 4295 lab 6:00pm - 8:50pm TTh D.A. JOHNSON D 133

FASHION DESIGN 256 2.00 UNITS
CAD APPAREL PRE-PRODUCTION TECHNIQUES

Evening Class
 4274 lab 6:00pm - 9:10pm MW C.E. SAPOS D 132

FASHION DESIGN 262 2.00 UNITS
INTRODUCTION TO CAD DESIGN AND PRE-PRODUCTION APPLICATIONS

7129 lab 8:35am - 3:05pm S C.E. SAPOS D 132

FASHION DESIGN 264 2.00 UNITS
APPAREL COMPUTER SYSTEMS ANALYSIS (CSU)

 7140 lec 11:45am - 12:45pm MW C.E. SAPOS D 133
 & lab 12:45pm - 3:30pm MW C.E. SAPOS D 133
(8 Week Class - Starts 4/12/2010, Ends 6/7/2010)
FASHION DESIGN 270 2.00 UNITS
ILLUSTRATOR FOR FASHION DESIGN

 Evening Class
 4279 lab 6:00pm - 9:10pm TTh L.L. ADAMS D 203

FASHION DESIGN 941 4.00 UNITS
COOPERATIVE EDUCATION - FASHION DESIGN

 9092 lec 4:25 hrs/wk TBA STAFF D 232
 > See page 73 for details and meeting times.

FASHION MERCHANDISING

FASHION MERCHANDISING 010 3.00 UNITS
RETAIL MERCHANDISING (CSU)

7161 lec 8:30am - 10:15am MW D.R. MURPHY D 200

FASHION MERCHANDISING 020 3.00 UNITS
APPAREL PRODUCT DEVELOPMENT (CSU)

7167 lec 12:00pm - 3:00pm F D.R. MURPHY D 200

FASHION MERCHANDISING 027 3.00 UNITS
ADVANCED RETAIL MERCHANDISING (CSU)

 7162 lec 12:45pm - 1:45pm TTh D.R. MURPHY D 200
 & lab 1:45pm - 3:00pm TTh D.R. MURPHY D 200

FASHION MERCHANDISING 035 3.00 UNITS
FASHION PROMOTION (CSU)

7164 lec 10:30am - 12:15pm MW D.R. MURPHY D 200

FASHION MERCHANDISING 040 3.00 UNITS
MODERN MERCHANDISING MATH (CSU)

7165 lec 8:30am - 10:15am TTh H. CHERNER K 304

FASHION MERCHANDISING 050 3.00 UNITS
INTERNATIONAL FASHION BUSINESS

7166 lec 10:45am - 12:30pm TTh D.R. MURPHY D 200

FASHION MERCHANDISING 941 4.00 UNITS
COOPERATIVE EDUCATION - FASHION MERCHANDISING

 9088 lec 4:25 hrs/wk TBA STAFF D 232
 > See page 73 for details and meeting times.

FRENCH

FRENCH 001 5.00 UNITS
ELEMENTARY FRENCH I (UC:CSU)

1420 lec 11:45am - 12:55pm MTWTh R. PALACIOS OCHOA K 364

FRENCH 002 5.00 UNITS
ELEMENTARY FRENCH II (UC:CSU)

1421 lec 1:40pm - 2:50pm MTWTh STAFF K 366

FRENCH 004 5.00 UNITS
INTERMEDIATE FRENCH II (UC:CSU)

6805 lec 1:30pm - 4:10pm MTh R. PALACIOS OCHOA K 364

GEOGRAPHY

GEOGRAPHY 001 3.00 UNITS
PHYSICAL GEOGRAPHY (UC:CSU)

1719 lec 10:10am - 11:35am TTh J. KRANZ H 301

 Evening Class
 4080 lec 6:00pm - 9:10pm M D.M. LANDAU H 352

GEOGRAPHY 002 3.00 UNITS
CULTURAL ELEMENTS OF GEOGRAPHY (UC:CSU)

7850 lec 3:15 hrs/wk TBA G.J. SCHWARTZ ON LINE

 > Please visit the online program homepage at <http://moodle.lattc.edu> prior to the start of class for directions, or see pages 70-72 of this schedule for more information.

GEOLOGY

GEOLOGY 001 3.00 UNITS
PHYSICAL GEOLOGY (UC:CSU)

1711 lec 8:30am - 11:40am S J.T. HALL H 354

GEOLOGY 006 2.00 UNITS
PHYSICAL GEOLOGY LABORATORY (CSU)

1715 lab 12:10pm - 3:20pm S J.T. HALL H 353

GRAPHIC DESIGN

 See classes under VISUAL COMMUNICATIONS – PAGES 66-67.

HEALTH

HEALTH 006 3.00 UNITS
NUTRITION FOR HEALTHFUL LIVING AND FITNESS ACTIVITIES (UC:CSU)

 Evening Class
 3801 lec 4:30pm - 6:35pm W S.L. SULLIVAN D 301
 & lab 6:35pm - 7:45pm W S.L. SULLIVAN D 301
 & lab 1:05 hrs/wk TBA S.L. SULLIVAN D 301

HEALTH 008 3.00 UNITS
WOMEN'S PERSONAL HEALTH (UC:CSU)

 1301 lec 11:45am - 1:10pm MW S.L. SULLIVAN D 325
 1302 lec 11:45am - 1:10pm TTh S.L. SULLIVAN D 325
 7900 lec 3:15 hrs/wk TBA L.D. DELZEIT ON LINE

 > Please visit the online program homepage at <http://moodle.lattc.edu> prior to the start of class for directions, or see pages 70-72 of this schedule for more information.

HEALTH 011						3.00 UNITS
PRINCIPLES OF HEALTHFUL LIVING (UC:CSU)						
1303	lec	7:00am - 8:25am	MW	M.A. WAGENBACH	D 301	
1304	lec	8:35am - 10:00am	MW	R.L. WELLS	D 301	
1305	lec	10:10am - 11:35am	MW	R.L. WELLS	D 301	
1306	lec	11:45am - 1:10pm	MW	R.L. WELLS	D 301	
1307	lec	1:20pm - 2:45pm	MW	S.L. SULLIVAN	D 301	
1308	lec	7:00am - 8:25am	TTh	M.A. WAGENBACH	D 301	
1309	lec	10:10am - 11:35am	TTh	R.L. WELLS	D 301	
1310	lec	11:45am - 1:10pm	TTh	R.L. WELLS	D 301	
7893	lec	3:15 hrs/wk	TBA	G.D. JOHNSON	ON LINE	
➤ Please visit the online program homepage at http://moodle.lattc.edu prior to the start of class for directions, or see pages 70-72 of this schedule for more information.						
3806	lec	6:00pm - 9:10pm	M	D.R. LAGOS	D 301	

Health 11 is also offered through Instructional Television (ITV) Program. For registration and orientation, see Ad on page 75

HEALTH 012						3.00 UNITS
SAFETY EDUCATION AND FIRST AID (UC:CSU)						
1312	lec	8:35am - 10:00am	TTh	D. DE FRANCO BROWNE	D 301	
HEALTH 021						3.00 UNITS
HUMAN SEXUALITY (UC:CSU)						
1314	lec	10:10am - 11:35am	MW	J.E. BUDINGER	D 325	
1315	lec	1:20pm - 2:45pm	MW	J.E. BUDINGER	D 325	

HEALTH OCCUPATIONS

HEALTH OCCUPATIONS 037						5.00 UNITS
NURSE ASSISTANT						
7790	lec	7:00am - 1:30pm	M	B. SOLES	T-L 100	
	& lab	7:00am - 1:45pm	ThF	B. SOLES	COUN VILL	
(8 Week Class - Starts 3/8/2010, Ends 5/7/2010)						
➤ Country Villa East, 2415 South Western Avenue, Los Angeles, CA 90018.						
7796	lec	7:00am - 1:30pm	M	B. SOLES	T-B 100	
	& lab	7:00am - 1:45pm	TW	R.L. GREEN WOMACK	COUN VILL	
(8 Week Class - Starts 3/8/2010, Ends 5/7/2010)						
➤ Country Villa East, 2415 South Western Avenue, Los Angeles, CA 90018.						

HEALTH OCCUPATIONS 038						2.00 UNITS
HOME HEALTH AIDE						
7791	lec	7:00am - 12:30pm	M	B. SOLES	T-B 100	
	& lab	7:00am - 1:45pm	ThF	B. SOLES	H OSP	
(2 Week Class - Starts 5/10/2010, Ends 5/21/2010)						
7797	lec	7:00am - 12:30pm	M	B. SOLES	T-B 100	
	& lab	7:00am - 1:45pm	TW	R.L. GREEN WOMACK	COUN VILL	
(2 Week Class - Starts 5/10/2010, Ends 5/21/2010)						
➤ Country Villa East, 2415 South Western Avenue, Los Angeles, CA 90018.						

HISTORY

HISTORY 011						3.00 UNITS
POLITICAL AND SOCIAL HISTORY OF THE UNITED STATES I (UC:CSU)						
1010	lec	8:35am - 10:00am	MW	D.B. JACKSON	F 211	
1011	lec	8:35am - 10:00am	MW	T.E. ROBINSON	F 215	
1012	lec	10:10am - 11:35am	MW	T.E. ROBINSON	F 215	
1014	lec	8:35am - 10:00am	TTh	T.E. ROBINSON	F 215	
1015	lec	11:45am - 1:10pm	MW	T.E. ROBINSON	F 215	
1016	lec	10:10am - 11:35am	TTh	D.B. JACKSON	F 211	
1017	lec	11:45am - 1:10pm	TTh	D.B. JACKSON	F 211	
7987	lec	3:15 hrs/wk	TBA	A.I. RODRIQUEZ ESTRADA	ON LINE	
➤ Please visit the online program homepage at http://moodle.lattc.edu prior to the start of class for directions, or see pages 70-72 of this schedule for more information.						
Evening Class						
3627	lec	6:00pm - 9:10pm	Th	B.D. FRIEDMAN	F 211	

History 11 is also offered through Instructional Television (ITV) Program. For registration and orientation, see Ad on page 75

HISTORY 012						3.00 UNITS
POLITICAL AND SOCIAL HISTORY OF THE UNITED STATES II (UC:CSU)						
1019	lec	11:45am - 1:10pm	MW	D.B. JACKSON	F 211	
1020	lec	8:35am - 10:00am	TTh	D.B. JACKSON	F 211	
1021	lec	11:45am - 1:10pm	TTh	T.E. ROBINSON	F 215	
7980	lec	3:15 hrs/wk	TBA	A.I. RODRIQUEZ ESTRADA	ON LINE	
➤ Please visit the online program homepage at http://moodle.lattc.edu prior to the start of class for directions, or see pages 70-72 of this schedule for more information.						
Evening Class						
3629	lec	6:00pm - 9:10pm	W	G. KINCSE	F 211	

History 12 is also offered through Instructional Television (ITV) Program. For registration and orientation, see Ad on page 75

HISTORY 042						3.00 UNITS
THE AFRICAN AMERICAN IN THE HISTORY OF THE U.S. II (UC:CSU)						
1022	lec	10:10am - 11:35am	TTh	T.E. ROBINSON	F 215	
HISTORY 087						3.00 UNITS
INTRODUCTION TO WORLD CIVILIZATION II (UC:CSU)						
1023	lec	10:10am - 11:35am	MW	D.B. JACKSON	F 211	

HUMANITIES

HUMANITIES 001						3.00 UNITS
CULTURAL PATTERNS OF WESTERN CIVILIZATION (UC:CSU)						
1403	lec	2:40pm - 5:50pm	T	C.D. PARKER	F 229	
1404	lec	8:35am - 10:00am	TTh	A.E. ARMSTRONG	F 235	
1405	lec	9:00am - 12:10pm	S	C.D. PARKER	F 229	
1406	lec	11:45am - 1:10pm	TTh	R.K. TROPF	F 229	
1433	lec	9:00am - 12:10pm	S	C.D. PARKER	F 214	
1434	lec	10:10am - 11:35am	MW	C.D. PARKER	F 229	
7941	lec	3:15 hrs/wk	TBA	M.A. GONZALEZ	ON LINE	
➤ Please visit the online program homepage at http://moodle.lattc.edu prior to the start of class for directions, or see pages 70-72 of this schedule for more information.						
Evening Class						
3895	lec	6:00pm - 9:10pm	T	C.D. PARKER	F 214	

HUMANITIES 002						3.00 UNITS
STUDIES IN SELECTED CULTURES (UC:CSU)						
1407	lec	10:10am - 11:35am	TTh	A.E. ARMSTRONG	F 235	

LABOR STUDIES

LABOR STUDIES 001						3.00 UNITS
AMERICAN LABOR HISTORY (CSU)						
7861	lec	3:15 hrs/wk	TBA	G. MAFFEI	ON LINE	
➤ Please visit the online program homepage at http://moodle.lattc.edu prior to the start of class for directions, or see pages 70-72 of this schedule for more information.						

LABOR STUDIES 003						3.00 UNITS
LABOR RELATIONS LAW (CSU)						
Evening Class						
3255	lec	6:00pm - 9:10pm	Th	D.S. ADELSTEIN	TEAM 396	
➤ Teamsters Local 396 880 Oak Pk Rd, Covina, CA 91724. Contact: Labor Center (213) 763-7129						

LABOR STUDIES 004						3.00 UNITS
LABOR IN AMERICA (CSU)						
0430	lec	10:10am - 11:35am	TTh	L. SIEGEL	L 107	
Evening Class						
3250	lec	6:00pm - 9:10pm	M	J.F. WALKER	UFCW 1428	
➤ UFCW Local 1428, 705 W. Arrow Hwy., Claremont, CA 91711. Contact: Labor Center (213) 763-7129						

LABOR STUDIES 005 **3.00 UNITS**
GRIEVANCE AND ARBITRATION PROCEDURES (CSU)0446 lec 8:30am - 5:20pm SU L.M. ZIGMAN T-L 100
(5 Week Class - Starts 4/17/2010, Ends 5/16/2010)**LABOR STUDIES 006** **3.00 UNITS**
LABOR AND COMMUNITY SERVICES (CSU)Evening Class
3251 lec 6:00pm - 9:10pm T STAFF CWA 9586
> CWA Local 9586, 12330 E. Firestone Blvd., Norwalk, CA 90650**LABOR STUDIES 007** **3.00 UNITS**
LABOR POLITICAL ACTION (CSU)Evening Class
3253 lec 6:00pm - 9:10pm W J.M. WHITE NALC 24
> NALC Branch 24, 774 Valencia St., Los Angeles, CA 90017. Contact: Labor Center (213) 763-7129**LABOR STUDIES 008** **3.00 UNITS**
LABOR ECONOMICS (UC:CSU)Evening Class
3252 lec 6:00pm - 9:10pm W G. WOLFF LACF 112
> Los Angeles City Firefighters Local 112, 1571 Beverly Blvd., Los Angeles, CA 90026. Contact: Labor Center (213) 763-7129**LABOR STUDIES 021** **3.00 UNITS**
THE WORKING CLASS AND CINEMA (UC:CSU)Evening Class
3254 lec 6:00pm - 9:10pm Th M.A. HART UFCW 324
> UFCW Local 324, 8530 Stanton Ave., Buena Park, CA 90622. Contact: Labor Center (213) 763-7129**LABOR STUDIES 101** **1.00 UNIT**
INTRODUCTION TO UNIONS0438 lec 8:30am - 5:20pm F J. MCMAHON LA CF
(2 Week Class - Starts 2/12/2010, Ends 2/19/2010)
> Los Angeles County Federation of Labor, 2130 W. James M. Wood Blvd., Los Angeles, CA 90006; Contact Labor Center (213) 763-7129
0447 lec 9:00am - 3:00pm S W.J. DELORO LA CF
(8 Week Class - Starts 2/20/2010, Ends 4/17/2010)
> Los Angeles County Federation of Labor, 2130 W. James M. Wood Blvd., Los Angeles, CA 90006; Contact Labor Center (213) 763-7129**LABOR STUDIES 103** **1.00 UNIT**
LABOR LAW UPDATE (CSU)0441 lec 8:30am - 5:20pm S A.N. STERN & L. LEVY T-L 100
(2 Week Class - Starts 2/27/2010, Ends 3/6/2010)**LABOR STUDIES 105** **1.00 UNIT**
GRIEVANCE HANDLING SKILLS (CSU)0439 lec 8:30am - 5:20pm S D. MAYER CSEA GLEN
(2 Week Class - Starts 2/27/2010, Ends 3/6/2010)
> CSEA Glendale, 1505 Gardena Ave., Glendale, CA 91204; Labor Center (213) 763-7029
0440 lec 8:30am - 5:20pm S L.M. ZIGMAN T-L 100
(1 Week Class - Starts 2/20/2010, Ends 2/21/2010)
0448 lec 9:00 hrs/wk TBA T. CONROW TEAM 848
(2 Week Class - Starts 3/10/2010, Ends 3/19/2010)**LABOR STUDIES 107** **1.00 UNIT**
ORGANIZING FOR POLITICAL ACTION (CSU)0443 lec 8:30am - 5:20pm SU J. GOMEZ T-L 100
(1 Week Class - Starts 4/10/2010, Ends 4/11/2010)**LABOR STUDIES 113** **1.00 UNIT**
UNION LEADERSHIP SEMINAR (CSU)0449 lec 8:30am - 5:20pm M T. CONROW ILWU 63
(2 Week Class - Starts 5/24/2010, Ends 5/31/2010)
> 350 West 5th Street, San Pedro, CA 90731. Contact: Labor Center (213) 763-7129**LABOR STUDIES 116** **1.00 UNIT**
NEW STRATEGIES FOR LABOR (CSU)0437 lec 8:30am - 2:20pm FSU M.A. MEJIA CSEA EL
(1 Week Class - Starts 2/19/2010, Ends 2/21/2010)
> CSEA El Monte, 4600 Santa Anita Ave., El Monte, CA 91731; Contact: Labor Center (213) 763-7129**LABOR STUDIES 120** **1.00 UNIT**
UNION ISSUES FOR WOMEN WORKERS (CSU)0444 lec 8:30am - 5:20pm S J. MCMAHON T-L 100
(1 Week Class - Starts 4/24/2010, Ends 4/25/2010)**LABOR STUDIES 132** **1.00 UNIT**
STRATEGIC BARGAINING (CSU)0442 lec 8:30am - 5:20pm S J.F. WALKER T-L 100
(2 Week Class - Starts 3/13/2010, Ends 3/20/2010)**LABOR STUDIES 136** **1.00 UNIT**
WHEN THE PAYCHECK STOPS0436 lec 8:30am - 5:20pm S G. MAFFEI RANC ELEM
(2 Week Class - Starts 4/24/2010, Ends 5/1/2010)
> Rancho Avenue Elementary School, 7940 Rancho Avenue, Panorama City, CA 91402. Contact: Labor Center at (213) 763-7129**LABOR STUDIES 185** **1.00 UNIT**
DIRECTED STUDY - LABOR STUDIES (CSU)3271 lec 1:05 hrs/wk TBA J.R. MCDOWELL LA CF
> Los Angeles County Federation of Labor, 2130 W. James M. Wood Blvd., Los Angeles, CA 90006; Contact Labor Center (213) 763-7129**LABOR STUDIES 285** **2.00 UNITS**
DIRECTED STUDY - LABOR STUDIES (CSU)3272 lec 2:05 hrs/wk TBA J.R. MCDOWELL LA CF
> Los Angeles County Federation of Labor, 2130 W. James M. Wood Blvd., Los Angeles, CA 90006; Contact Labor Center (213) 763-7129**LABOR STUDIES 385** **3.00 UNITS**
DIRECTED STUDY - LABOR STUDIES (CSU)3273 lec 3:15 hrs/wk TBA J.R. MCDOWELL LA CF
> Los Angeles County Federation of Labor, 2130 W. James M. Wood Blvd., Los Angeles, CA 90006; Contact Labor Center (213) 763-7129**LEARNING SKILLS****LEARNING SKILLS 001A** **1.00 UNIT**
READING A (NDA)1280 lab 3:15 hrs/wk TBA A.K. RANDALL C 102
1281 lab 3:15 hrs/wk TBA A.K. RANDALL C 102**LEARNING SKILLS 001B** **1.00 UNIT**
READING B (NDA)0352 lab 3:15 hrs/wk TBA A.K. RANDALL C 102
1283 lab 3:15 hrs/wk TBA A.K. RANDALL C 102**LEARNING SKILLS 001C** **1.00 UNIT**
READING C (NDA)1284 lab 3:15 hrs/wk TBA A.K. RANDALL C 102
1285 lab 3:15 hrs/wk TBA C.P. ANKETELL C 102**LEARNING SKILLS 002A** **1.00 UNIT**
ENGLISH FUNDAMENTALS A (NDA)0360 lab 3:15 hrs/wk TBA C.P. ANKETELL C 102
0361 lab 3:15 hrs/wk TBA C.P. ANKETELL C 212**LEARNING SKILLS 002B** **1.00 UNIT**
ENGLISH FUNDAMENTALS B (NDA)0364 lab 3:15 hrs/wk TBA C.P. ANKETELL C 102
0366 lab 3:15 hrs/wk TBA C.P. ANKETELL C 102**LEARNING SKILLS 002C** **1.00 UNIT**
ENGLISH FUNDAMENTALS C (NDA)0368 lab 3:15 hrs/wk TBA C.P. ANKETELL C 102
0369 lab 3:15 hrs/wk TBA C.P. ANKETELL C 102**LEARNING SKILLS 004** **1.00 UNIT**
THE MECHANICS OF SPELLING (NDA)

1289 lab 3:15 hrs/wk TBA M.C. ARMSTRONG C 102

LEARNING SKILLS 005						1.00 UNIT
ENGLISH AS A SECOND LANGUAGE FUNDAMENTALS (NDA)						
0427	lab	3:15 hrs/wk	TBA	M.C. ARMSTRONG	C 102	
LEARNING SKILLS 010A						1.00 UNIT
MATHEMATICS FUNDAMENTALS A (NDA)						
0379	lec	8:00am - 9:00am	T	A.K. RANDALL	C 200	
0380	lec	9:00am - 10:00am	M	A.K. RANDALL	C 200	
0381	lec	9:00am - 10:00am	T	A.K. RANDALL	C 200	
0382	lec	10:00am - 11:00am	M	A.K. RANDALL	C 200	
LEARNING SKILLS 010B						1.00 UNIT
MATHEMATICS FUNDAMENTALS B (NDA)						
0390	lab	2:25 hrs/wk	TBA	M.C. ARMSTRONG	C 102	
0392	lab	2:25 hrs/wk	TBA	M.C. ARMSTRONG	C 102	
LEARNING SKILLS 010C						1.00 UNIT
MATHEMATICS FUNDAMENTALS C (NDA)						
0370	lab	2:25 hrs/wk	TBA	M.C. ARMSTRONG	C 102	
1290	lab	2:25 hrs/wk	TBA	M.C. ARMSTRONG	C 102	
LEARNING SKILLS 039A						1.00 UNIT
CHILD DEVELOPMENT, LEARNING SKILLS - READING (NDA)						
0372	lab	2:25 hrs/wk	TBA	C.P. ANKTELL	C 102	
LEARNING SKILLS 039B						1.00 UNIT
CHILD DEVELOPMENT, LEARNING SKILLS - WRITING AND BIOLOGY (NDA)						
0373	lab	2:25 hrs/wk	TBA	C.P. ANKTELL	C 102	
LEARNING SKILLS 039C						1.00 UNIT
CHILD DEVELOPMENT, LEARNING SKILLS - MATH & EMPLOYMENT (NDA)						
0374	lab	0:55 hrs/wk	TBA	C.P. ANKTELL	C 102	
LEARNING SKILLS 062						1.00 UNIT
GED PREPARATION: LITERATURE AND THE ARTS (NDA)						
0375	lab	3:15 hrs/wk	TBA	M.C. ARMSTRONG	C 102	
LEARNING SKILLS 063						1.00 UNIT
GED PREPARATION: WRITING SKILLS (NDA)						
0376	lab	3:15 hrs/wk	TBA	M.C. ARMSTRONG	C 102	
LEARNING SKILLS 064						1.00 UNIT
GED PREPARATION: SCIENCE TEST (NDA)						
0377	lab	3:15 hrs/wk	TBA	M.C. ARMSTRONG	C 102	
LEARNING SKILLS 065						3.00 UNITS
GED PREPARATION: MATHEMATICS (NDA)						
0378	lab	3:15 hrs/wk	TBA	M.C. ARMSTRONG	C 102	
LEARNING SKILLS 066						1.00 UNIT
GED PREPARATION: SOCIAL STUDIES (NDA)						
0385	lab	3:15 hrs/wk	TBA	M.C. ARMSTRONG	C 102	
LEARNING SKILLS 185						1.00 UNIT
DIRECTED STUDY - LEARNING SKILLS (NDA)						
0417	lec	0:55 hrs/wk	TBA	A.K. RANDALL	C 102	
0425	lec	0:55 hrs/wk	TBA	A.K. RANDALL	C 102	

LIBRARY SCIENCE

LIBRARY SCIENCE 101						1.00 UNIT
LIBRARY RESEARCH METHODS (CSU)						
7829	lec	3:30 hrs/wk	TBA	R.R. KUZMICH	ON LINE	
<i>(5 Week Class - Starts 3/1/2010, Ends 4/3/2010)</i>						
➤ Please visit the online program homepage at http://moodle.lattc.edu prior to the start of class for directions, or see pages 70-72 of this schedule for more information.						
7830	lec	3:30 hrs/wk	TBA	R.R. KUZMICH	ON LINE	
<i>(5 Week Class - Starts 4/12/2010, Ends 5/14/2010)</i>						
➤ Please visit the online program homepage at http://moodle.lattc.edu prior to the start of class for directions, or see pages 70-72 of this schedule for more information.						

MACHINE SHOP

MACHINE SHOP 121						2.00 UNITS
PRINCIPLES OF MACHINE TOOLS II (CSU)						
0615	lec	7:00am - 8:25am	Th	P.A. RAUTERKUS	F 164C	
&	lec	7:00am - 8:25am	T	P.A. RAUTERKUS	F 164C	
MACHINE SHOP 122A						3.00 UNITS
TECHNOLOGY AND APPLICATION OF MACHINING IIA						
0616	lab	7:00am - 10:10am	MWF	P.A. RAUTERKUS	F 164	
MACHINE SHOP 122B						1.00 UNIT
TECHNOLOGY AND APPLICATION OF MACHINING IIB						
0617	lab	8:35am - 10:00am	TTh	P.A. RAUTERKUS	F 151A	
MACHINE SHOP 124						3.00 UNITS
PRINT INTERPRETATION AND INSPECTION (BLUEPRINT II) (CSU)						
0618	lec	10:10am - 11:35am	TTh	P.A. RAUTERKUS	F 164C	
MACHINE SHOP 125						3.00 UNITS
INTERMEDIATE APPLIED MATHEMATICAL CALCULATIONS (CSU)						
0619	lec	10:10am - 11:35am	MW	P.A. RAUTERKUS	F 164C	
MACHINE SHOP 141						2.00 UNITS
PRINCIPLES OF MACHINE TOOLS (CNC) IV (CSU)						
0623	lec	8:35am - 10:00am	T	S.T. SHIBUYA	F 166E	
&	lab	8:35am - 10:00am	Th	S.T. SHIBUYA	F 166	
MACHINE SHOP 142A						3.00 UNITS
TECHNOLOGY AND APPLICATION OF MACHINING IV A						
0624	lab	7:00am - 10:10am	MWF	S.T. SHIBUYA	F 166	
MACHINE SHOP 142B						1.00 UNIT
TECHNOLOGY AND APPLICATION OF MACHINING IV B						
0625	lec	7:00am - 8:25am	TTh	S.T. SHIBUYA	F 151A	
MACHINE SHOP 161A						3.00 UNITS
COMPUTER ASSISTED MACHING PROGRAMMING (CAM) IA						
0626	lec	10:10am - 11:35am	TTh	S.T. SHIBUYA	F 151A	
MACHINE SHOP 161B						3.00 UNITS
COMPUTER ASSISTED MACHINE PROGRAMMING (CAM) IB						
0627	lab	10:10am - 11:35am	MW	S.T. SHIBUYA	F 151A	

MANAGEMENT

MANAGEMENT 013						3.00 UNITS
SMALL BUSINESS ENTREPRENEURSHIP (CSU)						
0193	lec	11:45am - 1:10pm	TTh	K.L. GARY	K 324	

MARKETING

MARKETING 001						3.00 UNITS
PRINCIPLES OF SELLING (CSU)						
7957	lec	3:15 hrs/wk	TBA	M.C. BESSLER	ON LINE	
➤ Please visit the online program homepage at http://moodle.lattc.edu prior to the start of class for directions, or see pages 70-72 of this schedule for more information.						

MARKETING 011 **3.00 UNITS**
FUNDAMENTALS OF ADVERTISING (CSU)

7958 lec 3:15 hrs/wk TBA M.C. BESSLER ON LINE
 > Please visit the online program homepage at <http://moodle.lattc.edu> prior to the start of class for directions, or see pages 70-72 of this schedule for more information.

MARKETING 021 **3.00 UNITS**
PRINCIPLES OF MARKETING (CSU)

0254 lec 11:45am - 1:10pm MW M.C. BESSLER K 262

MATHEMATICS

MATHEMATICS 101 **3.00 UNITS**
THE WORLD OF NUMBERS (NDA)

1901 lec 8:35am - 10:00am MW N. SIMPSON-RODGERS E 306
 1902 lec 10:10am - 11:35am TTh C. LOOP E 306
 1903 lec 11:45am - 1:10pm TTh C. LOOP E 306

Evening Class
 4146 lec 6:00pm - 9:10pm T O.L. BARROW H 351

MATHEMATICS 105 **3.00 UNITS**
ARITHMETIC (NDA)

Prerequisite: MATH 101.
 1905 lec 8:35am - 10:00am MW H. LIU H 354
 1906 lec 1:10pm - 2:35pm TTh L.V. TRAN K 222
 1907 lec 7:00am - 8:25am MW M. TOWHIDLOW K 322
 1909 lec 8:35am - 10:00am TTh R.S. SHERER K 406
 1911 lec 11:45am - 1:10pm TTh R.S. SHERER K 406
 1913 lec 10:10am - 11:35am TTh H. LIU H 354
 1915 lec 11:45am - 1:10pm MW N. SIMPSON-RODGERS H 351
 1916 lec 10:10am - 11:35am MW M. TOWHIDLOW K 322
 1917 lec 10:10am - 11:35am TTh N. SIMPSON-RODGERS H 351
 7916 lec 3:15 hrs/wk TBA T.S. MEFTAGH ON LINE

> Please visit the online program homepage at <http://moodle.lattc.edu> prior to the start of class for directions, or see pages 70-72 of this schedule for more information.

Evening Class
 4151 lec 6:00pm - 9:10pm T R.S. SHERER K 262
 4152 lec 6:00pm - 9:10pm M O.L. BARROW H 354
 4153 lec 6:00pm - 9:10pm Th R. KUMADA H 354
 4154 lec 6:00pm - 9:10pm W G.N. DAGHER H 351

MATHEMATICS 112 **3.00 UNITS**
PRE-ALGEBRA (NDA)

Prerequisite: MATH 105.
 1920 lec 7:00am - 8:25am TTh M.A. EL TAWANSY K 301
 1924 lec 10:10am - 11:35am MW H. LIU H 354
 1926 lec 10:10am - 11:35am TTh C.K. CHEN H 352
 1927 lec 11:45am - 1:10pm MW M.A. CHAMMAS K 258
 1928 lec 8:35am - 10:00am TTh H. LIU H 354
 1929 lec 11:45am - 1:10pm TTh B.A. PAIGE K 321
 7917 lec 3:15 hrs/wk TBA T.S. MEFTAGH ON LINE

> Please visit the online program homepage at <http://moodle.lattc.edu> prior to the start of class for directions, or see pages 70-72 of this schedule for more information.

Evening Class
 4162 lec 6:00pm - 9:10pm M G.N. DAGHER H 351
 4163 lec 6:00pm - 9:10pm T M. BURGIN H 353

MATHEMATICS 113 **3.00 UNITS**
ELEMENTARY ALGEBRA A

Prerequisite: MATH 112.
 1932 lec 10:10am - 11:35am MW K.H. LEE H 353
 1933 lec 11:45am - 1:10pm TTh S. KUNARAK K 258

Evening Class
 4170 lec 6:00pm - 9:10pm W M.M. NAKANO H 354

MATHEMATICS 114 **3.00 UNITS**
ELEMENTARY ALGEBRA B

Prerequisite: Math 113.
 1936 lec 10:10am - 11:35am MW B.A. PAIGE H 352
 1937 lec 10:10am - 11:35am TTh S. KUNARAK K 258

Evening Class
 4176 lec 6:00pm - 9:10pm T M.M. NAKANO H 354

MATHEMATICS 115 **5.00 UNITS**
ELEMENTARY ALGEBRA

Prerequisite: MATH 112.
 1940 lec 7:00am - 8:10am MTWTh A.A. BAKMAN K 321
 1941 lec 7:00am - 8:10am MTWTh K.H. LEE H 353
 1942 lec 8:35am - 9:45am MTWTh M.M. MURPHY H 352
 1943 lec 8:35am - 9:45am MTWTh S. KUNARAK K 258
 1945 lec 10:10am - 11:20am MTWTh STAFF TBA 1
 1946 lec 11:45am - 12:55pm MTWTh H. LIU H 354
 1947 lec 11:45am - 12:55pm MTWTh T.S. MEFTAGH K 322
 1948 lec 8:00am - 1:20pm S Y.P. MANCHANDA K 406
 1949 lec 2:00pm - 4:30pm MW S. KUNARAK K 258
 1950 lec 2:00pm - 4:30pm TTh N. SIMPSON-RODGERS E 306
 7920 lec 5:30 hrs/wk TBA T.S. MEFTAGH ON LINE

> Please visit the online program homepage at <http://moodle.lattc.edu> prior to the start of class for directions, or see pages 70-72 of this schedule for more information.

Evening Class
 4180 lec 6:00pm - 8:35pm MW P.A. PETER K 258
 4181 lec 6:00pm - 8:35pm TTh M.N. NISHIMOTO H 352

MATHEMATICS 121 **3.00 UNITS**
ESSENTIALS OF PLANE GEOMETRY

Prerequisite: MATH 115 or MATH 113/114.
 1957 lec 8:35am - 10:00am TTh A. OVANESSIONIAN E 306

Course Sequence in Mathematics

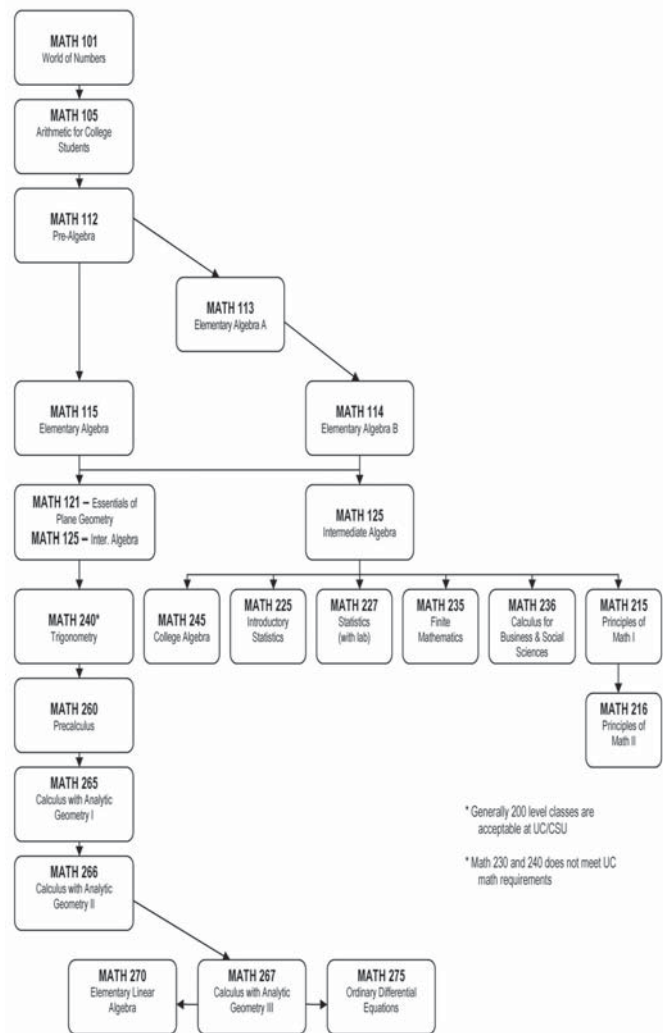

Note: Math Competency Exam given each semester. Meets elementary Algebra graduation requirements. Contact the Math Department at (213) 763-7330.

* Generally 200 level classes are acceptable at UC/CSU

* Math 230 and 240 does not meet UC math requirements



Los Angeles Trade-Technical College Spring 2010

1. Steps in the Financial Aid Application Process
2. Ability to Benefit Test (ATB)
3. BOGG Fee Waiver Application
4. LATTC Educational Programs & Certificates
5. Application for Admission

At Los Angeles Trade-Technical College, getting the information, forms, and assistance you need is as easy as going online (www.lattc.edu), or in person!

Online



In person





Los Angeles Trade-Tech College

H O N O R S

The Honors program provides highly motivated students with an intellectually challenging educational experience designed to prepare them for a successful transition from community college to university.

Why enroll?

- *Priority consideration when transferring*
- *More competitive application will contain references to and evidence of Honors participation*
- *Help ensure smoother transition to 4 year college or university*

Program Includes:

- *Honors library*
- *Honors club*

Program Includes:

- *Minimum 3.25 GPA in high school course work, or a minimum of 3.25 in at least 6 units of college course work, verified by transcripts and LATTC counselor.*
- *Eligibility for English 101*
- *Completion of Honors Program application*
- *Letter of recommendation from English Instructor or submission of research paper*

More information is available at lisamoreno.net

The Transfer Advantage!



TAKE COURSES HERE comparable to courses at Cal State, the UC system or private schools such as USC for only \$26 per unit. A 3-unit course at LATTC cost \$78 plus fees. The same course at a four-year school will range from \$160 to \$4200 plus fees!

MAKE EVERY COURSE COUNT! A transfer plan will not only help you to meet graduation requirements here at LATTC, but also for the four-year school you're planning to attend. You can also prepare for your four-year major now. That means you can transfer as a junior, have all your lower division major courses and general education completed and have an A.A. degree in Liberal Arts at the same time!

COME TO THE UNIVERSITY TRANSFER CENTER IN H-134, to meet with a counselor, visit with a university representative or sign up for a trip or workshop today. Office Hours: Monday- 9:00 a.m. to 6:00 p.m., Tuesday- 9:00 a.m. to 3:30 p.m., Wednesday- 9:00 a.m. to 3:00 p.m., Thursday 9:00 a.m. to 4:00 p.m., and Friday 9:00 a.m. to 1:00 p.m., (213) 763-7154. Telephone - (213) 763-7154.

Need Help?

Visit the **LEARNING SKILLS CENTER**

Room C-102 • (213) 763-3738 • www.lattc.edu/dept/tlsc/main.html

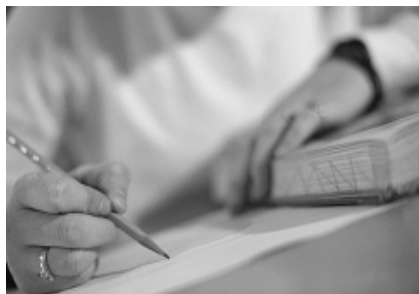

- Get help in basic skills reading, writing, and/or math
- Improve your grades
- Learn basic computer skills
- Use the computer to type papers and access online classes
- Receive tutoring
- Prepare for various tests such as the Abilities To Benefit, ACT Compass, Accuplacer, Nursing, GED, etc.
- Master English, math, and other skills such as times tables
- Develop better study skills strategies

Learning Skills Computer Lab:

The Learning Skills Computer Lab is available to students taking Learning Skills courses or using the lab for instructional purposes. The Learning Skills Lab is located in C-102. Knowledgeable and friendly faculty, staff, and tutors are available to assist students with various types of instructional software including, such as:

- Ainsworth and Greg College Keyboarding (Typing)
- GED Official Practice Tests by Steck-Vaughn (For GED preparation)
- Informal Reading & Arithmetic Tests
- KeyTrain (Online basic workplace skills training)
- Moodle (Portal for most LATTTC online classes)
- PLATO (Basic reading, writing, math, spelling – beginning to advanced)
- Reading Horizons (Phonics to beginning reading)
- Rosetta Stone (ESL listening, speaking, and writing)
- Steck-Vaughn Read On! (Beginning to advanced reading)
- Windows & Mouse Tutorial (Computer literacy)

Fall & Spring Hours:

Mon-Thur 8am-8pm
Fri 8am-2pm
Saturday 9am-1pm

Winter & Summer Hours:

Mon-Thur 8am-7pm
Fri 8am-2pm

Hours may vary during holidays

Open Computer Lab:

The Open Computer Lab, located in C-109, offers general computer usage including Internet and online class access. The Open Lab has a laser printer, scanner, and the latest software.

Learning Skills Classes:

Learning Skills offers non-degree applicable, for-credit classes to help students improve their basic reading, writing, math, and/or computer literacy skills.

Tutoring Center:

The Tutoring Center, located in C-102, provides tutorial services, both individually and in small groups.

Writing Center:

The Writing Center, located in C-100, offers assistance to students interested in improving their writing skills.



**All students must be enrolled at LATTTC and have a current LATTTC student ID card to use all Learning Skills facilities.*

THE FINANCIAL AID APPLICATION PROCESS

STUDENTS MUST REAPPLY FOR EACH ACADEMIC YEAR
APPLICATIONS ARE AVAILABLE YEAR-ROUND

- Step 1** The student submits their FAFSA (Free Application for Federal Student Aid) or Renewal via:
- FAFSA on line at www.fafsa.ed.gov;
 - Download the FAFSA form at www.FederalStudentAid.ed.gov; or
 - Call toll free at 1-800-433-3243 to request your own paper FAFSA.
- Application assistance is available in the Financial Aid Computer Lab located in the K-Building Basement, Room K004
- Step 2** The Federal Processor receives and processes the student's FAFSA.
- Step 3** In approximately two weeks, a paper Student Aid Report (SAR) is mailed or e-mailed to the student. (e-mail address must have been provided on the FAFSA).
- Step 4** Los Angeles Trade Technical College (LATTC) Financial Aid Office sends a Tracking Letter to the student, listing items required to complete their Financial Aid file and begin processing.
- Step 5** The student brings the requested documents/items to the LATTC Financial Aid Office, located in Temp. Bldg. TN-100
- Step 6** LATTC mails an Award Notification Letter to the student, showing their Financial Aid eligibility based on full time enrollment. The actual award amount disbursed is adjusted each semester based on actual units enrolled.
- Step 7** LATTC mails Financial Aid checks starting the first week of Fall semester for students who completed their Financial Aid file by the priority date of May 1st. Students who miss the priority processing deadline can expect to receive their checks at least 4 to 6 weeks after their file is completed.



Have you applied for Financial Aid?

If not, Fee Waiver and Free Application for Federal Student Aid (FAFSA) are still available. Los Angeles Trade Technical College offers over **\$15 million** of Federal and State Financial Aid each year!

You **may** be eligible to receive Fee Waiver and/or Financial Aid even if:

- You are working
- You are receiving welfare
- You enrolled in only one class
- You were not eligible in the past

Come to the Financial Aid Office and Lab for further assistance!

Phone: (213) 763-7082

Office Hours:

Monday-Friday 9:00 am to 2:00 pm

Monday-Thursday 4:30 pm to 7:30 pm

Location: Temporary Building TN-100

Lab Hours:

Monday-Friday 10:00 am to 2:00 pm

Monday -Thursday 4:30 pm to 6:00 pm

Location: K-Building Basement Room 004

THE ABILITY TO BENEFIT (ATB) TEST

FOR FEDERAL FINANCIAL AID



Assessment Center

(213) 763-5339

Location:

Building C - Room 107

Office Hours:

Monday: 9:00 a.m. - 5:00 p.m.
 Tuesday: 9:00 a.m. - 5:00 p.m.
 Wednesday: 9:00 a.m. - 8:00 p.m.
 Thursday: 9:00 a.m. - 5:00 p.m.
 Friday: 9:00 a.m. - 2:00 p.m.
 Saturday: Call for available dates and times.

Please REMEMBER that during testing:

- No food or drinks
- No children
- No calculators
- Cell phones and pagers MUST be turned OFF

The Ability To Benefit (ATB) Test is the same computerized assessment test offered during the enrollment process. The ATB test is used for students lacking a high school diploma or its equivalent who wish to apply for financial aid. This is not applicable to students who are currently enrolled in high school.

Students are tested on basic skills in Mathematics and English (or English as a Second Language, ESL). The test is not timed but students should allow themselves at least two hours to complete. Printed results of the test are given to the student after completion. To be eligible for financial aid, students must pass the three (3) test sections: Reading Comprehension, Sentence Skills, and Arithmetic. The scores are as follows:

Students who completed the native English speakers test:

<u>Reading Skills</u>	<u>55</u>
<u>Sentence Meaning</u>	<u>60</u>
<u>Arithmetic</u>	<u>34</u>
<u>Total possible points per section:</u>	<u>120</u>

Students who completed the English as a Second Language (ESL) test:

<u>Reading</u>	<u>70</u>
<u>Grammar Usage</u>	<u>64</u>
<u>Listening</u>	<u>70</u>
<u>Total possible points per section:</u>	<u>99</u>

Since this is a pass or fail test, it is recommended to review skills in these subjects prior to taking the assessment test. For sample questions go to: http://www.testprepreview.com/accu-placer_practice.htm

Students must bring a valid photo ID in order to take the test. There are NO EXCEPTIONS to this policy! The ID must be original, NO photocopies. Examples of ID include a California Driver's License, California ID, a passport, high school picture ID, etc.

Students that do not pass the ATB Test the first time may take it again. Please see below for retesting policy.

Test 1 ATBNO:	<i>Student can retest after 28 days.</i>
Test 2 ATBNO:	<i>Student can retest after receiving a passing grade of "C" or better in English, Math, or Learning Skills class.</i>
Test 3 ATBNO:	<i>Student can retest after one (1) year from original test date.</i>

California Community Colleges 2009-2010 Board of Governors Fee Waiver Application

*This is an application to have your **ENROLLMENT FEES WAIVED**. This **FEE WAIVER** is for California residents only. If you need money to help with books, supplies, food, rent, transportation and other costs, please complete a **FREE APPLICATION FOR FEDERAL STUDENT AID (FAFSA)** immediately. Contact the Financial Aid Office for more information. **The FAFSA is available at www.fafsa.ed.gov or at the Financial Aid Office.***

Note: Students who are exempt from paying nonresident tuition under **Education Code Section 68130.5 (AB 540)** are NOT California residents. If you are NOT a California resident, you are not eligible for a fee waiver. Do not complete this application. You may apply for financial aid by completing the FAFSA.

Name: _____	Student ID # _____
<i>Last</i> <i>First</i> <i>Middle Initial</i>	
Email (if available): _____	Telephone Number: (____) _____
Home Address: _____	Date of Birth: ____/____/____
<i>Street</i> <i>City</i> <i>Zip Code</i>	
Has the Admissions or Registrar's Office determined that you are a California resident? <input type="checkbox"/> Yes <input type="checkbox"/> No	

IMPLEMENTATION OF THE CALIFORNIA DOMESTIC PARTNER RIGHTS AND RESPONSIBILITIES ACT

The California Domestic Partner Rights and Responsibilities Act extends new rights, benefits, responsibilities and obligations to individuals in domestic partnerships registered with the California Secretary of State under Section 297 of the Family Code. If **you** are in a Registered Domestic Partnership (RDP), you will be treated as an Independent married student to determine eligibility for this Enrollment Fee Waiver and will need to provide income and household information for your domestic partner. If you are a dependent student and your parent is in a Registered Domestic Partnership, you will be treated the same as a student with married parents and income and household information will be required for the parent's domestic partner.

Note: These provisions apply to state student financial aid **ONLY**, and not to federal student financial aid.

Are you or your parent in a Registered Domestic Partnership with the California Secretary of State under Section 297 of the Family Code? (Answer "Yes" if you or your parent are separated from a Registered Domestic Partner but have **NOT FILED** a Notice of Termination of Domestic Partnership with the California Secretary of State's Office.) Yes No

If you answered "Yes" to the question above treat the Registered Domestic Partner as a spouse. You are required to include your domestic partner's income and household information or your parent's domestic partner's income and household information in Questions 4, 11, 12, 13, 14, 15, 16, 17.

Student Marital Status: Single Married Divorced Separated Widowed Registered Domestic Partnership

DEPENDENCY STATUS

The questions below will determine whether you are considered a Dependent student or Independent student for fee waiver eligibility and whether parental information is needed. If you answer "Yes" to **ANY** of the questions 1-10 below, you will be considered an INDEPENDENT student. If you answer "No" to all questions, you will be considered a Dependent student thereby reporting parental information and should continue with Question 11.

1. Were you born before January 1, 1986? (If "Yes," skip to question 13) Yes No
2. As of today, are you married or in a Registered Domestic Partnership (RDP)?
(Answer "Yes" if you are separated but not divorced or have not filed a termination notice to dissolve partnership. Also, if you answer "Yes," skip to question 13.) Yes No
3. Are you a veteran of the U.S. Armed Forces or currently serving on active duty for purposes other than training? (If "Yes," skip to question 13) Yes No
4. Do you have children who receive more than half of their support from you, or other dependents who live with you (other than your children and spouse/RDP) who receive more than half of their support from you, now and through June 30, 2010? (If "Yes," skip to question 13) Yes No
5. When you were age 13 or older, were both your parents deceased, were you in foster care or were you a dependent/ward of the court? (If "Yes," skip to question 13) Yes No
6. As of today, are you an emancipated minor as determined by a court in your state of legal residence?
(If "Yes," skip to question 13) Yes No

DEPENDENCY STATUS *(Continued)*

7. As of today, are you in legal guardianship as determined by a court in your state of legal residence?
(If "Yes," skip to question 13) Yes No
8. At any time on or after July 1, 2008, did your high school or school district homeless liaison determine that you were an unaccompanied youth who was homeless? (If "Yes," skip to question 13) Yes No
9. At any time on or after July 1, 2008, did the director of an emergency shelter program funded by the U.S. Department of Housing and Urban Development determine that you were an unaccompanied youth who was homeless?
(If "Yes," skip to question 13) Yes No
10. At any time on or after July 1, 2008, did the director of a runaway or homeless youth basic center or transitional living program determine that you were an unaccompanied youth who was homeless or were self-supporting and at risk of being homeless?
(If "Yes," skip to question 13) Yes No

• If you answered "Yes" to any of the questions 1 - 10, you are considered an INDEPENDENT student for enrollment fee waiver purposes and must provide income and household information about yourself (and your spouse or RDP if applicable). Skip to Question #13.

• If you answered "No" to all questions 1 - 10, complete the following questions:

11. If your parent(s) or his/her RDP filed or will file a 2008 U.S. Income Tax Return, were you, or will you be claimed on their tax return as an exemption by either or both of your parents? Will Not File Yes No
12. Do you live with one or both of your parent(s) and/or his/her RDP? Yes No

• If you answered "No" to questions 1 - 10 and "Yes" to either question 11 or 12, you must provide income and household information about your PARENT(S)/RDP. Please answer questions for a DEPENDENT student in the sections that follow.

• If you answered "No" or "Parent(s) will not file" to question 11, and "No" to question 12, you are a dependent student for all student aid except this enrollment fee waiver. You may answer questions as an INDEPENDENT student on the rest of this application, but please try to get your PARENT information and file a FAFSA so you may be considered for other student aid. You cannot get other student aid without your parent(s) information.

METHOD A ENROLLMENT FEE WAIVER

13. Are you (the student ONLY) currently receiving monthly cash assistance for yourself or any dependents from:
- TANF/CalWORKs? Yes No
- SSI/SSP (Supplemental Security Income/State Supplemental Program)? Yes No
- General Assistance? Yes No
14. If you are a dependent student, are your parent(s)/RDP receiving monthly cash assistance from TANF/CalWORKs or SSI/SSP as a primary source of income? Yes No

• If you answered "Yes" to question 13 or 14 you are eligible for an ENROLLMENT FEE WAIVER. Sign the Certification at the end of this form. You are required to show current proof of benefits. Complete a FAFSA to be eligible for other financial aid opportunities.

METHOD B ENROLLMENT FEE WAIVER

15. **DEPENDENT STUDENT:** How many persons are in your parent(s)/RDP household? (Include yourself, your parent(s)/RDP, and anyone who lives with your parent(s)/RDP and receives more than 50% of their support from your parents/RDP, now and through June 30, 2010.) _____
16. **INDEPENDENT STUDENT:** How many persons are in your household? (Include yourself, your spouse/RDP, and anyone who lives with you and receives more than 50% of their support from you, now and through June 30, 2010.) _____
17. **2008 Income Information**

	DEPENDENT STUDENT: PARENT(S)/RDP INCOME ONLY	INDEPENDENT STUDENT: STUDENT (& SPOUSE'S/ RDP) INCOME
(Dependent students should not include their income information for Q 17 a and b below.)		
a. Adjusted Gross Income (If 2008 U.S. Income Tax Return was filed, enter the amount from Form 1040, line 37; 1040A, line 21; 1040EZ, line 4).	\$ _____	\$ _____
b. All other income (Include ALL money received in 2008 that is not included in line (a) above (such as disability, child support, military living allowance, Workman's Compensation, untaxed pensions).	\$ _____	\$ _____
TOTAL Income for 2008 (Sum of a + b)	\$ _____	\$ _____

The Financial Aid Office will review your income and let you know if you qualify for an ENROLLMENT FEE WAIVER under Method B. If you do not qualify using this simple method, you should file a FAFSA.

SPECIAL CLASSIFICATIONS ENROLLMENT FEE WAIVERS

18. Do you have certification from the CA Department of Veterans Affairs that you are eligible for a dependent's fee waiver?
Submit certification. Yes No
19. Do you have certification from the National Guard Adjutant General that you are eligible for a dependent's fee waiver?
Submit certification. Yes No
20. Are you eligible as a recipient of the Congressional Medal of Honor or as a child of a recipient?
Submit documentation from the Department of Veterans Affairs. Yes No
21. Are you eligible as a dependent of a victim of the September 11, 2001, terrorist attack?
Submit documentation from the CA Victim Compensation and Government Claims Board. Yes No
22. Are you eligible as a dependent of a deceased law enforcement/fire suppression personnel killed in the line of duty?
Submit documentation from the public agency employer of record. Yes No

• If you answered "Yes" to any of the questions from 18-22, you are eligible for an ENROLLMENT FEE WAIVER and perhaps other fee waivers or adjustments. Sign the Certification below. Contact the Financial Aid Office if you have questions.

LOS ANGELES COMMUNITY COLLEGE DISTRICT

APPLICATION FOR ADMISSION

Please type or print clearly in black ink

<p>1. Student Identification Number (Leave blank unless you have previously been assigned a Student Identification Number)</p> <p>8 8</p>		<p>3. Legal Name</p> <p>Last _____ First _____ Middle Initial _____</p> <p>List other names you have used. If none, check box: <input type="checkbox"/></p> <p>Last _____ First _____ Middle Initial _____</p>	
<p>2. Social Security Number</p> <p>Students are required by law to provide their Social Security Number, which will be used for reporting to the federal government under the Taxpayer Relief Act of 1997 and for financial aid verification. If you do not have a Social Security number, or if you do not wish to use it, please leave blank.</p>		<p>4. Legal Address/Residence (Do not use P.O. Box or Business Address)</p> <p>Number _____ Street _____ Apt. No. _____</p> <p>City _____ State _____ Zip Code _____</p> <p>Have lived at this address since: _____ Month _____ Day _____ Year _____</p>	
<p>9. If you have lived at your present address fewer than two years, list previous addresses)</p> <p>Number/Street/Apt. No. _____ City/State _____ FROM: Mo/Yr _____ TO: Mo/Yr _____</p> <p>Number/Street/Apt. No. _____ City/State _____ FROM: Mo/Yr _____ TO: Mo/Yr _____</p>		<p>13. Contact Information</p> <p>Primary Telephone: (_____) _____ Area Code _____ Number _____</p> <p>E-mail: _____</p>	
<p>10. Mailing Address (if different from Legal Address given above)</p> <p>Number/Street/Apt. No. _____ City/State _____ Zip Code _____</p>		<p>14. Place of Birth</p> <p>City _____ State or Foreign Country _____</p>	
<p>11. My present stay in California began on:</p> <p>Are any of the following on active military duty? (Please check all that apply)</p> <p><input type="checkbox"/> Yourself <input type="checkbox"/> Spouse <input type="checkbox"/> Parents</p>		<p>15. Full name of the most recent High School you attended</p> <p>Name of High School _____ State or Foreign Country _____</p> <p>City _____</p>	
<p>12. The questions below must be answered by every applicant. (If you are under 19, answer for your parents)</p> <p>* Registered to vote in a state other than California? Yes No If yes, what year? _____</p> <p>* Filed a legal action in a state other than California? Yes No If yes, what year? _____</p> <p>* Attended a non-California college/university as a resident of that state? Yes No If yes, what year? _____</p> <p>* Filed as a Non-Resident for California State Income Tax Purposes? Yes No If yes, what year? _____</p>		<p>16. Last College attended. If none, check box: <input type="checkbox"/></p> <p>Name of College _____ Dates Attended _____</p> <p>City/State/Foreign Country _____ Degree Awarded _____</p>	
<p>The LACCD is made up of the following schools. Please check ONE school.</p> <p><input type="checkbox"/> City <input type="checkbox"/> East <input type="checkbox"/> Harbor <input type="checkbox"/> Mission <input type="checkbox"/> Pierce</p> <p><input type="checkbox"/> Southwest <input type="checkbox"/> Trade Tech <input type="checkbox"/> Valley <input type="checkbox"/> West LA <input type="checkbox"/> ITV</p>		<p>17. I am a citizen of _____ Country _____</p> <p>18. If you are not a United States Citizen, please circle and complete:</p> <p>2. Permanent Resident Alien _____ Permanent Resident or Visa Number _____</p> <p>3. Temporary Resident Alien _____</p> <p>4. Refugee, Asylee _____</p> <p>5. Student Visa (F-1 or M-1 visa) _____</p> <p>6. Other (Specify): _____ Issue/Adjustment Date _____</p> <p>7. Visitor Visa (B-1 or B-2 visa) _____</p>	
<p>OFFICE USE ONLY</p> <p>Residence _____</p> <p>Matriculation _____</p> <p>High School _____</p> <p>College _____</p> <p>Concurrent _____</p>			

CONTINUE ON OTHER SIDE

<p>19. Complete this question only if you are under 19 and have never been married.</p> <p>Name of Parent or Legal Guardian: _____</p> <p>Relationship to you: <input type="checkbox"/> Father <input type="checkbox"/> Mother <input type="checkbox"/> Legal Guardian <input type="checkbox"/> Other _____</p> <p>Is the person a: <input type="checkbox"/> U.S. Citizen <input type="checkbox"/> Permanent Resident Alien <input type="checkbox"/> Other _____</p> <p>If a Permanent Resident Alien, enter "A-Number" and date of issue: _____</p> <p>Current residence of this person: _____ From: _____ To: PRESENT State _____ Month/Year _____</p>	<p>24. Highest Education Status: Please enter number and year in boxes below</p> <p>1 = Earned a U.S. High School diploma (or will earn one before college semester begins) <input style="width: 50px;" type="text"/></p> <p>2 = Enrolled in grade 12 or below when college semester begins <input style="width: 50px;" type="text"/></p> <p>3 = Not a High School graduate, currently enrolled in adult school _____</p> <p>4 = Not a High School graduate, last attended High School _____</p> <p>5 = Passed the GED or received a certificate of H.S. equivalency _____</p> <p>6 = Earned California High School Proficiency Certificate _____</p> <p>7 = Earned a Foreign Secondary diploma or certificate of graduation _____</p> <p>8 = Earned an Associate degree _____</p> <p>9 = Earned a Bachelor's or higher degree _____</p>																						
<p>20. Ethnic Identity (*) Please enter number in box <input style="width: 50px;" type="text"/></p> <table style="width:100%; border: none;"> <tr> <td style="width:50%;">10 = Chinese</td> <td style="width:50%;">20 = Black, African-American</td> </tr> <tr> <td>11 = Japanese</td> <td>30 = Filipino</td> </tr> <tr> <td>12 = Korean</td> <td>40 = Mexican, Chicano,</td> </tr> <tr> <td>13 = Laotian</td> <td>50 = Mexican-American</td> </tr> <tr> <td>14 = Cambodian</td> <td>60 = American Indian, Alaskan Native</td> </tr> <tr> <td>15 = Vietnamese</td> <td>70 = Pacific Islander, Samoan</td> </tr> <tr> <td>16 = Indian Sub-Continent</td> <td>71 = Pacific Islander, Hawaiian</td> </tr> <tr> <td>17 = Other Asian</td> <td>72 = Pacific Islander, Guamanian</td> </tr> <tr> <td>18 = Other Asian</td> <td>73 = Other Pacific Islander</td> </tr> <tr> <td>19 = Other Asian</td> <td>74 = Other Non-White</td> </tr> <tr> <td></td> <td>75 = Decline to state</td> </tr> </table>	10 = Chinese	20 = Black, African-American	11 = Japanese	30 = Filipino	12 = Korean	40 = Mexican, Chicano,	13 = Laotian	50 = Mexican-American	14 = Cambodian	60 = American Indian, Alaskan Native	15 = Vietnamese	70 = Pacific Islander, Samoan	16 = Indian Sub-Continent	71 = Pacific Islander, Hawaiian	17 = Other Asian	72 = Pacific Islander, Guamanian	18 = Other Asian	73 = Other Pacific Islander	19 = Other Asian	74 = Other Non-White		75 = Decline to state	<p>25. Enrollment Status: Please enter number in box <input style="width: 50px;" type="text"/></p> <p>1 = First time college student</p> <p>2 = First time at this college, after attending another college</p> <p>3 = Returning to this college, after attending another college</p> <p>4 = Returning to this college, without having attended another college</p> <p>5 = Enrolling in this college, while attending school in the 12th or lower grade</p> <p>26. College Units or degree completed by first day of this term</p> <p>Please enter number in box <input style="width: 50px;" type="text"/></p> <p>1 = 0 units</p> <p>2 = 1 to 15 1/2</p> <p>3 = 16 to 29 1/2</p> <p>4 = 30 to 59 1/2</p> <p>5 = 60 or more units, no degree</p> <p>6 = A.A., A.S., B.A., B.S. or higher degree</p>
10 = Chinese	20 = Black, African-American																						
11 = Japanese	30 = Filipino																						
12 = Korean	40 = Mexican, Chicano,																						
13 = Laotian	50 = Mexican-American																						
14 = Cambodian	60 = American Indian, Alaskan Native																						
15 = Vietnamese	70 = Pacific Islander, Samoan																						
16 = Indian Sub-Continent	71 = Pacific Islander, Hawaiian																						
17 = Other Asian	72 = Pacific Islander, Guamanian																						
18 = Other Asian	73 = Other Pacific Islander																						
19 = Other Asian	74 = Other Non-White																						
	75 = Decline to state																						
<p>21. What is your primary language? (*) Please enter number in box <input style="width: 50px;" type="text"/></p> <table style="width:100%; border: none;"> <tr> <td style="width:50%;">1 = English</td> <td style="width:50%;">5 = Filipino</td> </tr> <tr> <td>2 = Armenian</td> <td>6 = Japanese</td> </tr> <tr> <td>3 = Chinese</td> <td>7 = Korean</td> </tr> <tr> <td>4 = Farsi</td> <td>8 = Russian</td> </tr> <tr> <td></td> <td>9 = Spanish</td> </tr> <tr> <td></td> <td>10 = Vietnamese</td> </tr> <tr> <td></td> <td>11 = Other language _____</td> </tr> </table>	1 = English	5 = Filipino	2 = Armenian	6 = Japanese	3 = Chinese	7 = Korean	4 = Farsi	8 = Russian		9 = Spanish		10 = Vietnamese		11 = Other language _____	<p>27. Veteran (Leave blank, unless you are a veteran) <input style="width: 50px;" type="text"/></p> <p>Were you honorably discharged from the U.S. Armed Forces? <input type="checkbox"/> Yes <input type="checkbox"/> No</p>								
1 = English	5 = Filipino																						
2 = Armenian	6 = Japanese																						
3 = Chinese	7 = Korean																						
4 = Farsi	8 = Russian																						
	9 = Spanish																						
	10 = Vietnamese																						
	11 = Other language _____																						
<p>22. What is your main educational goal? Please enter number in box <input style="width: 50px;" type="text"/></p> <p>1 = Prepare for a new career (acquire new job skills)</p> <p>2 = Advance in current job/career (update job skills)</p> <p>3 = Discover/develop career interests, plans and goals</p> <p>4 = Obtain a two-year vocational degree without transfer</p> <p>5 = Obtain a two-year Associate degree without transfer</p> <p>6 = Obtain a vocational certificate without transfer</p> <p>7 = Obtain a Bachelor's degree after completing an Associate's degree</p> <p>8 = Obtain a Bachelor's degree without completing an Associate's degree</p> <p>9 = Maintain certificate or license (e.g. Nursing, Real Estate)</p> <p>10 = Improve basic skills in English, reading or math</p> <p>11 = Complete credits for high school diploma or GED</p> <p>12 = Personal development (intellectual, cultural)</p> <p>13 = Undecided on goal</p>	<p>28. Student Information -- Permission to Release</p> <p>TYPES OF STUDENT INFORMATION: (1) <i>Directory Information:</i> name; city of residence; participation in officially recognized activities and sports; weight and height of athletic team members; dates of attendance; degrees and awards received; and the most recent previous educational institution attended. (2) <i>College Foundation Information:</i> name, address, and telephone number. (3) <i>Four-year College Information:</i> name, address, and phone number. (4) <i>Military Recruiting Information:</i> "Directory information", plus address, telephone number, date of birth, and major field of study.</p> <p><input type="checkbox"/> I DO NOT permit the release of directory information</p> <p><input type="checkbox"/> I DO NOT permit the release of information to the College Foundation</p> <p><input type="checkbox"/> I DO NOT permit the release of information to four-year colleges</p> <p><input type="checkbox"/> I DO NOT permit the release of information to the military</p> <p>You may change your Directory Release at any time by completing a Release of Directory Information form and returning it to the Admissions Office.</p>																						
<p>23. Special Services (*)</p> <p>The Los Angeles Community College District is committed to increasing your educational success. Each area listed below provides special services. Please indicate those services that interest you.</p> <table style="width:100%; border: none;"> <tr> <td style="width:50%;">1. <input type="checkbox"/> Financial Aid</td> <td style="width:50%;">5. <input type="checkbox"/> Employment Assistance</td> </tr> <tr> <td>2. <input type="checkbox"/> Child Care</td> <td>6. <input type="checkbox"/> Information regarding special services and/or accommodations for students with disabilities may be obtained from the Disabled Student Programs (DSPS) Office.</td> </tr> <tr> <td>3. <input type="checkbox"/> Tutoring</td> <td>7. <input type="checkbox"/> Are you from a low income family and in need of special counseling, tutoring, and/or financial aid assistance? <input type="checkbox"/> Yes <input type="checkbox"/> No</td> </tr> <tr> <td>4. <input type="checkbox"/> Transfer Assistance</td> <td></td> </tr> </table> <p>(* NOTICE TO STUDENTS: Your responses to questions marked by this symbol will be used to provide you with information on college programs and services and/or for statistical purposes only. Refusal to provide this information will not be used to deny admission to the college or any of its programs.</p> <p>If additional information is needed to determine your residence status you will be required to complete a supplemental residence questionnaire and/or to present evidence in accordance with Education Code sections 68040 et seq. The burden of proof to clearly demonstrate both physical presence in California and intent to establish California residence lies with the student.</p>	1. <input type="checkbox"/> Financial Aid	5. <input type="checkbox"/> Employment Assistance	2. <input type="checkbox"/> Child Care	6. <input type="checkbox"/> Information regarding special services and/or accommodations for students with disabilities may be obtained from the Disabled Student Programs (DSPS) Office.	3. <input type="checkbox"/> Tutoring	7. <input type="checkbox"/> Are you from a low income family and in need of special counseling, tutoring, and/or financial aid assistance? <input type="checkbox"/> Yes <input type="checkbox"/> No	4. <input type="checkbox"/> Transfer Assistance		<p>29. Certification</p> <p>I declare under penalty of perjury that all information on this form is correct. I understand that falsifying or withholding information required on this form shall constitute grounds for dismissal.</p> <p>REQUIRED SIGNATURE _____ Date _____</p>														
1. <input type="checkbox"/> Financial Aid	5. <input type="checkbox"/> Employment Assistance																						
2. <input type="checkbox"/> Child Care	6. <input type="checkbox"/> Information regarding special services and/or accommodations for students with disabilities may be obtained from the Disabled Student Programs (DSPS) Office.																						
3. <input type="checkbox"/> Tutoring	7. <input type="checkbox"/> Are you from a low income family and in need of special counseling, tutoring, and/or financial aid assistance? <input type="checkbox"/> Yes <input type="checkbox"/> No																						
4. <input type="checkbox"/> Transfer Assistance																							

MATHEMATICS 125 5.00 UNITS
INTERMEDIATE ALGEBRA

Prerequisite: MATH 115 or MATH 113/114

1960	lec	7:00am - 8:10am	MTWTh	L.F. AVILA	K 258
1961	lec	8:35am - 9:45am	MTWTh	L.F. AVILA	K 325
1962	lec	10:10am - 11:20am	MTWTh	E.M. LIGHT	K 301
1963	lec	11:45am - 12:55pm	MTWTh	K.H. LEE	H 353
1964	lec	8:35am - 9:45am	MTWTh	A.A. BAKMAN	K 262
7921	lec	5:30 hrs/wk	TBA	T.S. MEFTAGH	ON LINE

➤ Please visit the online program homepage at <http://moodle.lattc.edu> prior to the start of class for directions, or see pages 70-72 of this schedule for more information.

Evening Class

4190	lec	6:00pm - 8:35pm	MW	B.T. BAYSSA	H 353
4191	lec	6:00pm - 8:35pm	TTh	N. SIMPSON-RODGERS	E 306

Math 125 is also offered through Instructional Television (ITV) Program. For registration and orientation, see Ad on page 75

MATHEMATICS 225 3.00 UNITS
INTRODUCTORY STATISTICS (UC:CSU)

Prerequisite: MATH 125.

Evening Class

4210	lec	6:00pm - 9:10pm	T	P.A. PETER	K 324
4211	lec	6:00pm - 9:10pm	Th	P.A. KARASIK	K 324

MATHEMATICS 227 4.00 UNITS
STATISTICS (UC:CSU)

Prerequisite: MATH 125.

1978	lec	10:10am - 12:20pm	MW	A.A. BAKMAN	K 324
1979	lec	10:10am - 12:20pm	TTh	L.F. AVILA	K 325
7922	lec	4:20 hrs/wk	TBA	A.A. BAKMAN	ON LINE

➤ Please visit the online program homepage at <http://moodle.lattc.edu> prior to the start of class for directions, or see pages 70-72 of this schedule for more information.

MATHEMATICS 236 5.00 UNITS
CALCULUS FOR BUSINESS AND SOCIAL SCIENCE (UC:CSU)

Prerequisite: MATH 125.

1981	lec	11:45am - 12:55pm	MTWTh	M.M. MURPHY	H 352
------	-----	-------------------	-------	-------------	-------

MATHEMATICS 240 3.00 UNITS
TRIGONOMETRY (CSU)

Prerequisites: MATH 121 and 125.

1982	lec	7:00am - 8:25am	MW	M.M. MURPHY	H 352
------	-----	-----------------	----	-------------	-------

MATHEMATICS 245 3.00 UNITS
COLLEGE ALGEBRA (UC:CSU)

Prerequisite: MATH 125.

1985	lec	10:10am - 11:35am	TTh	K.H. LEE	H 353
------	-----	-------------------	-----	----------	-------

Evening Class

4216	lec	6:00pm - 9:10pm	T	V. ZINENBERG	K 321
------	-----	-----------------	---	--------------	-------

MATHEMATICS 260 5.00 UNITS
PRE-CALCULUS (UC:CSU)

Prerequisite: MATH 240.

1990	lec	11:45am - 12:55pm	MTWTh	E.M. LIGHT	K 301
------	-----	-------------------	-------	------------	-------

MATHEMATICS 265 5.00 UNITS
CALCULUS WITH ANALYTIC GEOMETRY I (UC:CSU)

Prerequisite: MATH 260.

1992	lec	8:35am - 9:45am	MTWTh	E.M. LIGHT	K 301
------	-----	-----------------	-------	------------	-------

MATHEMATICS 266 5.00 UNITS
CALCULUS WITH ANALYTIC GEOMETRY II (UC:CSU)

Prerequisite: MATH 265.

1993	lec	7:00am - 8:10am	MTWTh	H. LIU	H 354
------	-----	-----------------	-------	--------	-------

MATHEMATICS 267 5.00 UNITS
CALCULUS WITH ANALYTIC GEOMETRY III (UC:CSU)

Prerequisite: MATH 266.

1994	lec	8:35am - 9:45am	MTWTh	K.H. LEE	H 353
------	-----	-----------------	-------	----------	-------

MATHEMATICS 275 3.00 UNITS
ORDINARY DIFFERENTIAL EQUATIONS (UC:CSU)

Prerequisite: MATH 267

1996	lec	10:10am - 11:35am	MW	L.F. AVILA	K 325
------	-----	-------------------	----	------------	-------

MICROBIOLOGY

MICROBIOLOGY 001 5.00 UNITS
INTRODUCTORY MICROBIOLOGY (UC:CSU)

Prerequisites: BIOLOGY 3 or 6 or 36 and CHEM 51 or 101 with a grade of "C" or better

1645	lec	7:30am - 9:00am	MW	S.M. HOSSEINI	K 408
&	lab	9:00am - 12:20pm	MW	S.M. HOSSEINI	K 408

MICROBIOLOGY 020 4.00 UNITS
GENERAL MICROBIOLOGY (UC:CSU)

Prerequisites: BIOLOGY 3 or 6 or 36 and CHEM 51 or 101 with a grade of "C" or better

1648	lec	8:30am - 11:40am	T	M.C. PANTASTICO CALDAS	K 408
&	lab	8:30am - 11:40am	Th	M.C. PANTASTICO CALDAS	K 408
1649	lec	12:30pm - 3:40pm	M	R.K. WONG	K 408
&	lab	12:30pm - 3:40pm	W	R.K. WONG	K 408

Evening Class

4060	lec	6:00pm - 9:10pm	M	E.H. BROCKMANN	K 408
&	lab	6:00pm - 9:10pm	W	E.H. BROCKMANN	K 408

MICROCOMPUTER TECHNICIAN

MICROCOMPUTER TECHNICIAN 077 3.00 UNITS
CISCO NETWORKING ACADEMY - SEMESTER I

0521	lec	7:00am - 9:05am	T	R.W. CAMPBELL	E 200
&	lab	9:25am - 12:35pm	T	R.W. CAMPBELL	E 200

Evening Class

3307	lec	6:00pm - 8:05pm	T	R.W. CAMPBELL	E 200
&	lab	6:00pm - 9:10pm	Th	R.W. CAMPBELL	E 200

MICROCOMPUTER TECHNICIAN 078 3.00 UNITS
CISCO NETWORKING ACADEMY - SEMESTER II

0524	lec	7:00am - 9:05am	F	R.W. CAMPBELL	E 200
&	lab	9:25am - 12:35pm	F	R.W. CAMPBELL	E 200

MICROCOMPUTER TECHNICIAN 079 3.00 UNITS
CISCO NETWORKING ACADEMY - SEMESTER III

0527	lec	7:00am - 9:05am	F	R.W. CAMPBELL	E 200
&	lab	9:25am - 12:35pm	F	R.W. CAMPBELL	E 200

MICROCOMPUTER TECHNICIAN 080 3.00 UNITS
CISCO NETWORKING ACADEMY - SEMESTER IV

0529	lec	7:00am - 9:05am	F	R.W. CAMPBELL	E 200
&	lab	9:25am - 12:35pm	F	R.W. CAMPBELL	E 200

MICROCOMPUTER TECHNICIAN 160 2.00 UNITS
IT ESSENTIALS APPLICATION SOFTWARE FUNDAMENTALS

0531	lec	10:10am - 12:10pm	W	E.L. CHAVEZ	E 106
&	lab	10:10am - 12:25pm	Th	E.L. CHAVEZ	E 106

MICROCOMPUTER TECHNICIAN 162 4.00 UNITS
IT ESSENTIALS NETWORKING PERSONAL COMPUTERS

0533	lec	7:00am - 10:00am	T	E.L. CHAVEZ	E 105
&	lab	10:10am - 12:30pm	T	E.L. CHAVEZ	E 106
&	lab	7:00am - 10:00am	Th	E.L. CHAVEZ	E 106

MICROCOMPUTER TECHNICIAN 164 5.00 UNITS
IT ESSENTIALS MICROCOMPUTER THEORY AND SERVICING

0535	lec	7:00am - 10:10am	M	E.L. CHAVEZ	E 105
&	lab	10:10am - 1:10pm	M	E.L. CHAVEZ	E 106
&	lab	7:00am - 10:10am	W	E.L. CHAVEZ	E 105

**MICROCOMPUTER TECHNICIAN 165
LINUX SURVIVAL COURSE (UC:CSU)**

3.00 UNITS

Evening Class					
3364	lec	6:00pm - 8:10pm	T	R.W. CAMPBELL	E 200
&	lab	6:00pm - 9:10pm	Th	R.W. CAMPBELL	E 200

MOTORCYCLE REPAIR MECHANIC

**MOTORCYCLE REPAIR MECHANIC 210
INTERNAL COMBUSTION ENGINE THEORY AND REPAIR**

4.00 UNITS

7496	lec	7:30am - 8:30am	S	R.R. PRICE	F 124
&	lab	8:30am - 1:40pm	S	R.R. PRICE	F 124
Evening Class					
4500	lec	6:30pm - 7:30pm	TTh	R.R. PRICE	F 124
&	lab	7:30pm - 9:40pm	TTh	R.R. PRICE	F 124

**MOTORCYCLE REPAIR MECHANIC 212
MOTORCYCLE SERVICE AND TUNE-UP THEORY AND REPAIR**

4.00 UNITS

7497	lec	7:30am - 8:30am	S	R.R. PRICE	F 124
&	lab	8:30am - 1:40pm	S	R.R. PRICE	F 124
Evening Class					
4501	lec	6:30pm - 7:30pm	TTh	R.R. PRICE	F 124
&	lab	7:30pm - 9:40pm	TTh	R.R. PRICE	F 124

**MOTORCYCLE REPAIR MECHANIC 214
MULTI-CYLINDER ELECTRICAL PRINCIPLES AND REPAIR**

4.00 UNITS

7498	lec	7:30am - 8:30am	S	R.R. PRICE	F 124
&	lab	8:30am - 1:40pm	S	R.R. PRICE	F 124
Evening Class					
4502	lec	6:30pm - 7:30pm	TTh	R.R. PRICE	F 124
&	lab	7:30pm - 9:40pm	TTh	R.R. PRICE	F 124

**MOTORCYCLE REPAIR MECHANIC 216
MULTI-CYLINDER DIAGNOSIS AND OVERHAUL**

4.00 UNITS

7499	lec	7:30am - 8:30am	S	R.R. PRICE	F 124
&	lab	8:30am - 1:40pm	S	R.R. PRICE	F 124
Evening Class					
4503	lec	6:30pm - 7:30pm	TTh	R.R. PRICE	F 124
&	lab	7:30pm - 9:40pm	TTh	R.R. PRICE	F 124

MUSIC

**MUSIC 101
FUNDAMENTALS OF MUSIC (UC:CSU)**

3.00 UNITS

1467	lec	10:10am - 11:35am	MW	S.D. CANON	D 300
1470	lec	8:35am - 10:00am	MW	E.J. RAY	D 300
1471	lec	10:10am - 11:35am	TTh	S.D. CANON	D 300
1472	lec	11:45am - 1:10pm	TTh	S.D. CANON	D 300
Evening Class					
6816	lec	3:45pm - 5:50pm	TTh	M.B. WACHS	CALS HAS
➤ CALS HS Academy, 700 Wilshire Blvd., Los Angeles, CA 90017. Contact Claudia Leottaud					

**MUSIC 141
JAZZ APPRECIATION (UC:CSU)**

3.00 UNITS

1575	lec	11:45am - 1:10pm	TTh	S.D. CANON	D 300
------	-----	------------------	-----	------------	-------

**MUSIC 321
ELEMENTARY PIANO I (UC:CSU)**

2.00 UNITS

1469	lec	8:35am - 10:00am	TTh	S.D. CANON	D 350
&	lab	10:10am - 11:35am	TTh	S.D. CANON	D 350

**MUSIC 322
ELEMENTARY PIANO II (UC:CSU)**

2.00 UNITS

1464	lec	8:35am - 10:00am	TTh	S.D. CANON	D 350
&	lec	10:10am - 11:35am	TTh	S.D. CANON	D 350

**MUSIC 323
ELEMENTARY PIANO III (UC:CSU)**

2.00 UNITS

1478	lec	8:35am - 10:00am	TTh	S.D. CANON	D 350
&	lec	10:10am - 11:35am	TTh	S.D. CANON	D 350

**MUSIC 324
ELEMENTARY PIANO IV (UC:CSU)**

2.00 UNITS

1466	lec	8:35am - 10:00am	TTh	S.D. CANON	D 350
&	lab	10:10am - 11:35am	TTh	S.D. CANON	D 350

**MUSIC 341
INTERMEDIATE PIANO (UC:CSU)**

2.00 UNITS

1468	lec	8:35am - 10:00am	TTh	S.D. CANON	D 350
&	lab	10:10am - 11:35am	TTh	S.D. CANON	D 350

**MUSIC 650
BEGINNING GUITAR (UC:CSU)**

2.00 UNITS

6814	lec	9:00am - 10:00am	S	T.M. CARTER	D 350
&	lab	10:00am - 12:10pm	S	T.M. CARTER	D 350
6856	lec	9:00am - 10:00am	S	J.M. CHEESMAN	D 300
&	lab	10:00am - 12:10pm	S	J.M. CHEESMAN	D 300
Evening Class					
3922	lec	6:00pm - 9:10pm	M	E.J. RAY	D 300

NURSING SCIENCE

**NURSING SCIENCE 101
INTRODUCTION TO NURSING**

3.00 UNITS

Prerequisites: Psychology 1 & 41					
7724	lec	8:00am - 11:10am	Th	C.M. ASHBY	T-L 100
&	lab	7:00am - 1:30pm	TW	B. SOLES	OLYM MC
(8 Week Class - Starts 2/8/2010, Ends 4/9/2010)					
➤ Olympia Medical Center, 5900 W. Olympic Center, Los Angeles, CA 90036.					
7725	lec	8:00am - 11:10am	Th	C.M. ASHBY	T-L 100
&	lab	7:00am - 1:30pm	TW	C.M. ASHBY	CA HOSP
(8 Week Class - Starts 2/8/2010, Ends 4/9/2010)					
➤ California Hospital, 1401 South Grand Ave., Los Angeles, CA 90015.					
7726	lec	8:00am - 11:10am	Th	C.M. ASHBY	T-L 100
&	lab	7:00am - 1:30pm	TW	R.C. VILLORA	CA HOSP
(8 Week Class - Starts 2/8/2010, Ends 4/9/2010)					
➤ California Hospital, 1401 South Grand Ave., Los Angeles, CA 90015.					
7727	lec	8:00am - 11:10am	Th	C.M. ASHBY	T-L 100
&	lab	7:00am - 1:30pm	TW	P. JOHNSON	WM MC
(8 Week Class - Starts 2/8/2010, Ends 4/9/2010)					
➤ White Memorial Medical Center, 1720 Cesar E. Chavez Ave., Los Angeles, CA 90033.					

**NURSING SCIENCE 102
FUNDAMENTALS OF NURSING**

3.00 UNITS

7721	lec	8:00am - 11:10am	Th	C.M. ASHBY	T-L 100
&	lab	7:00am - 1:30pm	TW	B. SOLES	OLYM MC
(8 Week Class - Starts 4/12/2010, Ends 6/7/2010)					
➤ Olympia Medical Center, 5900 W. Olympic Center, Los Angeles, CA 90036.					
7723	lec	8:00am - 11:10am	Th	C.M. ASHBY	T-L 100
&	lab	7:00am - 1:30pm	TW	R.C. VILLORA	CA HOSP
(8 Week Class - Starts 4/12/2010, Ends 6/7/2010)					
➤ California Hospital, 1401 South Grand Ave., Los Angeles, CA 90015.					
7728	lec	8:00am - 11:10am	Th	C.M. ASHBY	T-L 100
&	lab	7:00am - 1:30pm	TW	C.M. ASHBY	CA HOSP
(8 Week Class - Starts 4/12/2010, Ends 6/7/2010)					
➤ California Hospital, 1401 South Grand Ave., Los Angeles, CA 90015.					
7729	lec	8:00am - 11:10am	Th	C.M. ASHBY	T-L 100
&	lab	7:00am - 1:30pm	TW	P. JOHNSON	WM MC
(8 Week Class - Starts 4/12/2010, Ends 6/7/2010)					
➤ White Memorial Medical Center, 1720 Cesar E. Chavez Ave., Los Angeles, CA 90033.					

NURSING SCIENCE 103 1.00 UNIT
NURSING PROCESS (UC:CSU)

7765 lec 1:00pm - 3:20pm Th D.A. JENKINSON T-H 100
(8 Week Class - Starts 2/8/2010, Ends 4/9/2010)

NURSING SCIENCE 104 1.00 UNIT
NURSING COMMUNICATION

7737 lec 1:00pm - 3:20pm Th M.D. KENDRICK T-H 100
(8 Week Class - Starts 4/12/2010, Ends 6/7/2010)

NURSING SCIENCE 105 2.00 UNITS
NURSING PHARMACOLOGY

7740 lec 8:00am - 9:45am M R.C. VILLORA T-H 100
& lab 10:00am - 11:45am M R.C. VILLORA T-H 100

NURSING SCIENCE 106 5.00 UNITS
MEDICAL-SURGICAL NURSING I

7730 lec 1:00pm - 4:20pm M C.P. WASHINGTON T-B 100
& lec 9:00am - 12:20pm W C.P. WASHINGTON T-H 100
& lab 7:00am - 7:50pm Th C.P. WASHINGTON CEDA SINA

(8 Week Class - Starts 2/8/2010, Ends 4/9/2010)
➤ Cedars Sinai Medical Center, 8700 Beverly Blvd., Los Angeles, CA 90048.

7731 lec 1:00pm - 4:20pm M C.P. WASHINGTON T-L 100
& lec 9:00am - 12:20pm W C.P. WASHINGTON T-L 100
& lab 7:00am - 7:50pm T L.V. JACOBS PA MC

(8 Week Class - Starts 2/8/2010, Ends 4/9/2010)
➤ Pacific Alliance Medical Center, 531 College St., Los Angeles, CA 90012.

7732 lec 1:00pm - 4:20pm M C.P. WASHINGTON T-H 100
& lec 9:00am - 12:20pm W C.P. WASHINGTON T-H 100
& lab 7:00am - 7:50pm Th C.P. WASHINGTON CEDA SINA

(8 Week Class - Starts 4/12/2010, Ends 6/7/2010)
➤ Cedars Sinai Medical Center, 8700 Beverly Blvd., Los Angeles, CA 90048.

7733 lec 1:00pm - 4:20pm M C.P. WASHINGTON T-B 100
& lec 9:00am - 12:20pm W C.P. WASHINGTON T-H 100
& lab 7:00am - 7:50pm Th L.V. JACOBS PA MC

(8 Week Class - Starts 4/12/2010, Ends 6/7/2010)
➤ Pacific Alliance Medical Center, 531 College St., Los Angeles, CA 90012.

NURSING SCIENCE 107 5.00 UNITS
MEDICAL-SURGICAL NURSING II

7734 lec 9:00am - 12:20pm M M.D. KENDRICK T-H 100
& lec 9:00am - 12:20pm W M.D. KENDRICK T-H 100
& lab 7:00am - 7:50pm T M.D. KENDRICK CA HOSP

(8 Week Class - Starts 2/8/2010, Ends 4/9/2010)
➤ California Hospital, 1401 South Grand Ave., Los Angeles, CA 90015.

7735 lec 9:00am - 12:20pm M M.D. KENDRICK T-H 100
& lec 9:00am - 12:20pm W M.D. KENDRICK T-H 100
& lab 7:00am - 8:05pm T L.V. JACOBS PA MC

(8 Week Class - Starts 2/8/2010, Ends 4/9/2010)
➤ Pacific Alliance Medical Center, 531 College St., Los Angeles, CA 90012.

7736 lec 9:00am - 12:20pm M M.D. KENDRICK T-H 100
& lab 9:00am - 12:20pm W M.D. KENDRICK T-H 100
& lab 7:00am - 7:50pm T M.D. KENDRICK CA HOSP

(8 Week Class - Starts 4/12/2010, Ends 6/7/2010)
➤ California Hospital, 1401 South Grand Ave., Los Angeles, CA 90015.

7738 lec 9:00am - 12:20pm M M.D. KENDRICK T-H 100
& lec 9:00am - 12:20pm W M.D. KENDRICK T-H 100
& lab 7:00am - 7:50pm T L.V. JACOBS PA MC

(8 Week Class - Starts 4/12/2010, Ends 6/7/2010)
➤ Pacific Alliance Medical Center, 531 College St., Los Angeles, CA 90012.

NURSING SCIENCE 108 3.00 UNITS
MEDICAL-SURGICAL NURSING III

7760 lec 12:30pm - 3:20pm M D.A. JENKINSON T-B 100
& lab 7:00am - 5:00pm F D.A. JENKINSON CEDA SINA

(8 Week Class - Starts 2/8/2010, Ends 4/9/2010)
➤ Cedars Sinai Medical Center, 8700 Beverly Blvd., Los Angeles, CA 90048.

7761 lec 12:30pm - 3:20pm M D.A. JENKINSON T-B 100
& lab 7:00am - 5:00pm T D.A. JENKINSON KAIS ER

(8 Week Class - Starts 2/8/2010, Ends 4/9/2010)
➤ Kaiser Permanente Medical Center (Sunset), 4867 Sunset Blvd., Los Angeles, CA 90027. Contact Joanie Yamahata 323-783-4011

7762 lec 12:30pm - 3:20pm M D.A. JENKINSON T-B 100
& lab 7:00am - 5:00pm F C.M. ASHBY CA HOSP

(8 Week Class - Starts 2/8/2010, Ends 4/9/2010)
➤ California Hospital, 1401 South Grand Ave., Los Angeles, CA 90015.

NURSING SCIENCE 109 2.00 UNITS
GERONTOLOGY & COMMUNITY BASED NURSING

7770 lec 11:30am - 1:20pm T R.M. MIDDLETON T-B 100
& lab 7:00am - 1:45pm Th R.M. MIDDLETON H OSP

(8 Week Class - Starts 2/8/2010, Ends 4/9/2010)

7771 lec 11:30am - 1:20pm T R.M. MIDDLETON T-B 100
& lab 7:00am - 2:25pm F R.M. MIDDLETON H OSP

(8 Week Class - Starts 2/8/2010, Ends 4/9/2010)

7772 lec 11:30am - 1:20pm T R.M. MIDDLETON T-B 100
& lab 7:00am - 1:45pm F R.M. MIDDLETON H OSP

(8 Week Class - Starts 4/12/2010, Ends 6/7/2010)

7773 lec 11:00am - 1:20pm T R.M. MIDDLETON T-B 100
& lab 7:00am - 2:25pm Th R.M. MIDDLETON H OSP

(8 Week Class - Starts 4/12/2010, Ends 6/7/2010)

NURSING SCIENCE 110 3.00 UNITS
PSYCHIATRIC-MENTAL HEALTH NURSING

7756 lec 9:00am - 12:20pm W R.L. WEINGOURT T-B 100
& lab 7:00am - 5:00pm F STAFF CEDA SINA

(8 Week Class - Starts 2/8/2010, Ends 4/9/2010)
➤ Cedars Sinai Medical Center, 8700 Beverly Blvd., Los Angeles, CA 90048.

7757 lec 9:00am - 12:20pm W R.L. WEINGOURT T-B 100
& lab 7:00am - 3:35pm Th STAFF CEDA SINA

(8 Week Class - Starts 2/8/2010, Ends 4/9/2010)
➤ Cedars Sinai Medical Center, 8700 Beverly Blvd., Los Angeles, CA 90048.

7758 lec 9:00am - 12:20pm W R.L. WEINGOURT T-B 100
& lab 7:00am - 5:05pm Th STAFF CEDA SINA

(8 Week Class - Starts 4/12/2010, Ends 6/7/2010)
➤ Cedars Sinai Medical Center, 8700 Beverly Blvd., Los Angeles, CA 90048.

7759 lec 9:00am - 12:20pm W R.L. WEINGOURT T-B 100
& lab 7:00am - 5:00pm F STAFF CEDA SINA

(8 Week Class - Starts 4/12/2010, Ends 6/7/2010)
➤ Cedars Sinai Medical Center, 8700 Beverly Blvd., Los Angeles, CA 90048.

NURSING SCIENCE 111 3.50 UNITS
REPRODUCTIVE NURSING AND WOMENS HEALTH

7745 lec 9:00am - 2:05pm T C.C. CHANDLER T-H 100
& lab 7:00am - 5:50pm M C.C. CHANDLER T-H 100

(8 Week Class - Starts 2/8/2010, Ends 4/9/2010)

7746 lec 9:00am - 2:05pm T C.C. CHANDLER T-H 100
& lab 7:00am - 5:50pm F C.C. CHANDLER HOLL PRES

(8 Week Class - Starts 2/8/2010, Ends 4/9/2010)
➤ Hollywood Presbyterian Medical Center, 1300 North Vermont Ave., Los Angeles, CA 90027. 213-413-3000

7747 lec 9:00am - 2:05pm T C.C. CHANDLER T-H 100
& lab 7:00am - 5:50pm M C.C. CHANDLER HOLL PRES

(8 Week Class - Starts 4/12/2010, Ends 6/7/2010)
➤ Hollywood Presbyterian Medical Center, 1300 North Vermont Ave., Los Angeles, CA 90027. 213-413-3000

7748 lec 9:00am - 2:05pm T C.C. CHANDLER T-H 100
& lab 7:00am - 7:50pm F C.C. CHANDLER HOLL PRES

(8 Week Class - Starts 4/12/2010, Ends 6/7/2010)
➤ Hollywood Presbyterian Medical Center, 1300 North Vermont Ave., Los Angeles, CA 90027. 213-413-3000

NURSING SCIENCE 112 3.50 UNITS
CARE OF CHILDREN AND FAMILY

7751 lec 8:00am - 12:20pm W J.H. REILEY T-L 100
& lab 7:00am - 7:00pm T STAFF T-H 100

(8 Week Class - Starts 2/8/2010, Ends 4/9/2010)

7752 lec 8:00am - 12:20pm W J.H. REILEY T-L 100
& lab 7:00am - 7:00pm T J.H. REILEY USC VILL

(8 Week Class - Starts 2/8/2010, Ends 3/29/2010)
➤ USC - University Village, 3333 Hoover St., Los Angeles, CA

7753 lec 8:00am - 12:20pm W J.H. REILEY T-L 100
& lab 7:00am - 7:00pm F J.H. REILEY H OSP

(8 Week Class - Starts 2/8/2010, Ends 4/9/2010)

NURSING SCIENCE 114 3.00 UNITS
NURSING LEADERSHIP & MANAGEMENT

7775 lec 12:30pm - 3:35pm T D.A. JENKINSON T-H 100
& lab 15:50 hrs/wk TBA D.A. JENKINSON H OSP

(8 Week Class - Starts 4/12/2010, Ends 6/7/2010)

7776 lec 12:30pm - 3:35pm T D.A. JENKINSON T-H 100
& lab 16:00 hrs/wk TBA J.H. REILEY H OSP

(8 Week Class - Starts 4/12/2010, Ends 6/7/2010)

7777 lec 12:30pm - 3:35pm T D.A. JENKINSON T-H 100
or lab 16:00 hrs/wk TBA R.M. MIDDLETON H OSP

(8 Week Class - Starts 4/12/2010, Ends 6/7/2010)

NURSING SCIENCE 115 BASIC SKILLS ENHANCEMENT LAB (CSU)	1.00 UNIT
7798 lab 1:15 hrs/wk TBA C.M. ASHBY	T-C 100
NURSING SCIENCE 116 SKILLS ENHANCEMENT LABORATORY	2.00 UNITS
7800 lab 2:15 hrs/wk TBA R.C. VILLORA	T-K 100

OCEANOGRAPHY

Oceanography is offered through Instructional Television (ITV) Program. For registration and orientation, see Ad on page 75

OFFICE MACHINES

OFFICE MACHINES 002 ADDING AND CALCULATING MACHINES	1.00 UNIT
0263 lab 1:15pm - 3:20pm T V.M. EMERSON	K 324

PARALEGAL

PARALEGAL 003 CIVIL RIGHTS AND THE LAW (CSU)	3.00 UNITS
0198 lec 10:10am - 11:35am MW K.L. GARY	K 204
PARALEGAL 016 CIVIL AND CRIMINAL EVIDENCE	3.00 UNITS
0189 lec 11:45am - 1:10pm MW K.L. GARY	K 204

PERSONAL DEVELOPMENT

PERSONAL DEVELOPMENT 002 INTERPERSONAL RELATIONSHIPS (CSU)	1.00 UNIT
9581 lec 2:00pm - 3:05pm W G.M. ROSARIO	F 231
9582 lec 1:30pm - 2:35pm M L.M. BRENT	F 231
& lec 1:15 hrs/wk TBA L.M. BRENT	F 231
(6 Week Class - Starts 2/22/2010, Ends 3/29/2010)	
9583 lec 1:30pm - 2:35pm M L.M. BRENT	F 231
& lec 1:15 hrs/wk TBA L.M. BRENT	F 231
& lec 1:15 hrs/wk TBA L.M. BRENT	F 231
(6 Week Class - Starts 4/12/2010, Ends 5/17/2010)	
PERSONAL DEVELOPMENT 004 CAREER PLANNING (CSU)	1.00 UNIT
9584 lec 1:00pm - 2:05pm Th K.D. SKINNER	K 322
PERSONAL DEVELOPMENT 020 POST SECONDARY EDUCATION: THE SCOPE OF CAREER PLANNING (CSU)	3.00 UNITS
➤ Section numbers 9586 and 9587 designated as UMOJA emphasis courses.	
9586 lec 8:30am - 11:30am T K.D. SKINNER	TBA 1
9587 lec 8:30am - 11:00am W M.L. BURNETT	TBA 1

PERSONAL DEVELOPMENT 022 THE TRANSFER PROCESS (UC:CSU)	1.00 UNIT
9585 lec 11:45am - 12:50pm T A. HOSSEINI	K 305

PHILOSOPHY

PHILOSOPHY 001 INTRODUCTION TO PHILOSOPHY (UC:CSU)	3.00 UNITS
1568 lec 8:35am - 10:00am TTh V.G. SHIRIKJIAN	F 227
1500 lec 8:35am - 10:00am MW M.E. SARGENT	F 227
1501 lec 10:10am - 11:35am MW M.E. SARGENT	F 227
Evening Class	
3946 lec 6:00pm - 9:10pm T R.J. EGAN	F 227

Philosophy I is also offered through Instructional Television (ITV) Program. For registration and orientation, see Ad on page 75

PHILOSOPHY 008 DEDUCTIVE LOGIC (UC:CSU)	3.00 UNITS
1503 lec 10:10am - 11:35am TTh V.G. SHIRIKJIAN	F 227
Evening Class	
3947 lec 6:00pm - 9:10pm Th R.J. EGAN	F 227

PHYSICAL EDUCATION

PHYSICAL EDUCATION 101 SWIMMING-NON/SWIMMER (UC:CSU)	1.00 UNIT
2101 lab 11:45am - 1:10pm TTh J.E. RATCLIFF	P OOL
2103 lab 10:10am - 11:35am TTh J.E. RATCLIFF	P OOL
2105 lab 11:45am - 1:10pm MW J.E. RATCLIFF	P OOL
2107 lab 9:00am - 12:10pm S M.D. MAYFIELD	P OOL
2708 lab 10:10am - 11:35am MW J.E. RATCLIFF	P OOL
PHYSICAL EDUCATION 102 SWIMMING SKILLS (UC:CSU)	1.00 UNIT
2102 lab 11:45am - 1:10pm TTh J.E. RATCLIFF	P OOL
2104 lab 10:10am - 11:35am TTh J.E. RATCLIFF	P OOL
2106 lab 11:45am - 1:10pm MW J.E. RATCLIFF	P OOL
2709 lab 10:10am - 11:35am MW J.E. RATCLIFF	P OOL
PHYSICAL EDUCATION 131 AQUA AEROBICS (UC:CSU)	1.00 UNIT
2131 lab 1:20pm - 2:45pm MW L.D. DELZEIT	P OOL
2132 lab 1:20pm - 2:45pm TTh C.L. SWATEK	P OOL
PHYSICAL EDUCATION 170 WALKING FOR FITNESS (UC:CSU)	1.00 UNIT
2170 lab 10:10am - 11:35am MW S.L. SULLIVAN	J 205
2171 lab 10:10am - 11:35am TTh S.L. SULLIVAN	J 212
PHYSICAL EDUCATION 462 MODERN DANCE (UC:CSU)	1.00 UNIT
2481 lab 11:45am - 1:00pm MW D. DE FRANCO BROWNE	J 212
2482 lab 11:45am - 1:00pm TTh D. DE FRANCO BROWNE	J 212
PHYSICAL EDUCATION 465 AEROBICS FOR DANCE (UC:CSU)	1.00 UNIT
2466 lab 10:10am - 11:35am MW D. DE FRANCO BROWNE	G 100
PHYSICAL EDUCATION 500 BASKETBALL THEORY (UC:CSU)	3.00 UNITS
2500 lec 3:00pm - 4:30pm TTh R.L. WELLS	D 325
& lab 4:30pm - 5:50pm TTh R.L. WELLS	G 100
(13 Week Class - Starts 3/15/2010, Ends 6/7/2010)	

PHYSICAL EDUCATION 513						3.00 UNITS
INTERCOLLEGIATE SPORTS - SWIMMING (UC:CSU)						
2513	lab	11:05 hrs/wk	TBA	S. LUEDECKE	P OOL	
PHYSICAL EDUCATION 515						3.00 UNITS
INTERCOLLEGIATE SPORTS - TRACK AND FIELD (UC:CSU)						
2515	lab	11:05 hrs/wk	TBA	M.A. WAGENBACH	J FLD	
PHYSICAL EDUCATION 552						1.00 UNIT
ATHLETICS PRE-SEASON CONDITIONING (UC:CSU)						
Evening Class						
2552	lab	6:00pm - 7:25pm	MW	W.V. VALLEJO	J 212	
PHYSICAL EDUCATION 628						1.00 UNIT
SWIM AND RUN FOR FITNESS (UC:CSU)						
2245	lab	10:10am - 11:35am	MW	M.A. WAGENBACH	P OOL	
7912	lab	3:15 hrs/wk	TBA	M.A. WAGENBACH	ON LINE	
➤ Please visit the online program homepage at http://moodle.lattc.edu prior to the start of class for directions, or see pages 70-72 of this schedule for more information.						
PHYSICAL EDUCATION 665						1.00 UNIT
BASKETBALL (UC:CSU)						
Evening Class						
2256	lab	6:00pm - 10:00pm	Th	R.L. WELLS	G 100	
(13 Week Class - Starts 3/15/2010, Ends 6/7/2010)						
PHYSICAL EDUCATION 666						1.00 UNIT
BODY CONDITIONING (UC:CSU)						
2260	lab	7:00am - 8:25am	MW	J.E. BUDINGER	LRC BASE	
2261	lab	8:35am - 10:00am	MW	J.E. BUDINGER	LRC BASE	
2262	lab	10:10am - 11:35am	MW	J.G. BROWNE	LRC BASE	
2263	lab	11:45am - 1:10pm	MW	D.R. LAGOS	LRC BASE	
2264	lab	1:20pm - 2:45pm	MW	J.G. BROWNE	LRC BASE	
PHYSICAL EDUCATION 690						1.00 UNIT
WEIGHT TRAINING (UC:CSU)						
2278	lab	11:45am - 1:10pm	TTh	D.R. LAGOS	LRC BASE	
2279	lab	9:00am - 12:10pm	S	B.C. PFIFFNER	LRC BASE	
2280	lab	7:00am - 8:25am	TTh	J.E. BUDINGER	LRC BASE	
2282	lab	10:10am - 11:35am	TTh	J.E. BUDINGER	LRC BASE	
2284	lab	1:20pm - 2:35pm	TTh	J.E. BUDINGER	LRC BASE	
2285	lab	8:35am - 10:00am	TTh	J.E. RATCLIFF	LRC BASE	
Evening Class						
2903	lab	6:00pm - 7:25pm	TTh	S.E. SECK	LRC BASE	
PHYSICAL EDUCATION 742						1.00 UNIT
CARDIO KICKBOXING (UC:CSU)						
2295	lab	8:35am - 10:00am	TTh	J.E. BUDINGER	G 100	
PHYSICAL EDUCATION 750						3.00 UNITS
SPORTS ETHICS (CSU)						
7915	lec	3:15 hrs/wk	TBA	J.G. BROWNE	ON LINE	
➤ Please visit the online program homepage at http://moodle.lattc.edu prior to the start of class for directions, or see pages 70-72 of this schedule for more information.						
PHYSICAL EDUCATION 762						3.00 UNITS
ANCIENT OLYMPIC GAMES						
7907	lec	3:15 hrs/wk	TBA	J.G. BROWNE	ON LINE	
➤ Please visit the online program homepage at http://moodle.lattc.edu prior to the start of class for directions, or see pages 70-72 of this schedule for more information.						
PHYSICAL EDUCATION 800						3.00 UNITS
INTRODUCTION TO DANCE AND DANCE HISTORY (UC:CSU)						
2480	lec	10:10am - 11:35am	TTh	D. DE FRANCO BROWNE	D 325	
PHYSICAL EDUCATION 814						2.00 UNITS
DANCE PRODUCTION I (UC:CSU)						
2490	lec	4:40 hrs/wk	TBA	D. DE FRANCO BROWNE	J 212	
&	lab	2:30 hrs/wk	TBA	D. DE FRANCO BROWNE	J 212	
(8 Week Class - Starts 4/12/2010, Ends 6/7/2010)						

PHYSICS

PHYSICS 001						4.00 UNITS
MECHANICS OF SOLIDS (UC:CSU)						
1739	lec	10:10am - 11:35am	W	R.J. POWERS	K 420	
&	lec	12:10pm - 1:35pm	Th	R.J. POWERS	K 420	
&	lab	12:10pm - 3:20pm	W	M.A. EL TAWANSY	K 422	
PHYSICS 002						4.00 UNITS
MECHANICS OF FLUIDS, HEAT, AND SOUND (UC:CSU)						
Recommended Preparation: Physics 1 & Math 266 with a grade of "C" or better.						
1740	lec	10:10am - 11:35am	MTh	R.J. POWERS	K 420	
&	lec	12:10pm - 3:20pm	M	R.J. POWERS	K 420	
PHYSICS 004						4.00 UNITS
OPTICS AND MODERN PHYSICS (UC:CSU)						
Recommended Preparation: Physics 3 with a grade of "C" or better and co-enrollment in Math 267.						
1744	lec	1:30pm - 4:40pm	T	M.A. MORENO	K 420	
&	lab	1:30pm - 4:40pm	Th	M.A. MORENO	K 420	
PHYSICS 007						4.00 UNITS
GENERAL PHYSICS II (UC:CSU)						
Recommended Preparation: Physics 6 with a grade of "C" or better.						
1743	lec	6:30pm - 9:40pm	M	M.A. MORENO	USC EART	
&	lab	12:40pm - 3:50pm	F	M.A. MORENO	K 468	
➤ First class meeting will be at LATTC, Room K-422, USC - University Park Campus Earth Science, Building B-56. Contact 213-763-7295.						
1746	lec	6:30pm - 9:40pm	M	M.A. MORENO	USC EART	
&	lab	2:50pm - 6:00pm	W	M.A. MORENO	K 420	
➤ First class meeting will be at LATTC, Room K-422, USC - University Park Campus Earth Science, Building B-56. Contact 213-763-7295.						
PHYSICS 011						4.00 UNITS
INTRODUCTORY PHYSICS (UC:CSU)						
1745	lec	7:00am - 10:10am	T	M.A. EL TAWANSY	K 420	
&	lab	7:00am - 10:10am	Th	M.A. EL TAWANSY	K 422	
1759	lec	7:00am - 10:10am	F	F.J. PADILLA	K 406	
&	lab	10:10am - 1:20pm	F	F.J. PADILLA	K 422	
Evening Class						
4090	lec	6:00pm - 9:10pm	T	T.M. GOODMAN	K 301	
&	lab	6:00pm - 9:10pm	Th	T.M. GOODMAN	K 301	
PHYSICS 012						3.00 UNITS
PHYSICS FUNDAMENTALS (UC:CSU)						
1750	lec	12:20pm - 1:45pm	TTh	M.A. EL TAWANSY	K 420	
1760	lec	7:00am - 10:10am	F	F.J. PADILLA	K 406	
Evening Class						
4091	lec	6:00pm - 9:10pm	T	T.M. GOODMAN	K 422	
PHYSICS 014						1.00 UNIT
PHYSICS FUNDAMENTALS LABORATORY (UC:CSU)						
Recommended Preparation: Physics 12 or ENTLGY 111, 112, & 113 with a grade of "C" or better.						
1761	lab	10:10am - 1:20pm	F	F.J. PADILLA	K 422	
PHYSICS 029A						3.00 UNITS
BASIC PHYSICS FOR TECHNICIANS A						
1765	lec	8:35am - 10:00am	MW	F.J. PADILLA	K 422	
PHYSICS 029B						1.00 UNIT
BASIC PHYSICS FOR TECHNICIANS B						
1766	lab	7:00am - 10:10am	Th	F.J. PADILLA	K 422	
PHYSICS 185						1.00 UNIT
DIRECTED STUDY - PHYSICS (CSU)						
1796	lec	1:15 hrs/wk	TBA	M.A. MORENO	K 422	
PHYSICS 285						2.00 UNITS
DIRECTED STUDY - PHYSICS (CSU)						
1800	lec	2:15 hrs/wk	TBA	M.A. MORENO	K 422	
PHYSICS 385						3.00 UNITS
DIRECTED STUDY - PHYSICS (CSU)						
1801	lec	3:15 hrs/wk	TBA	M.A. MORENO	K 422	
1802	lec	3:15 hrs/wk	TBA	F.J. PADILLA	K 420	

PLUMBING

PLUMBING 026 PLUMBING LAYOUT AND ESTIMATING I Evening Class 4746 lec 6:00pm - 9:10pm M T.E. SWEIGART	3.00 UNITS B 200B
PLUMBING 027 PLUMBING LAYOUT AND ESTIMATING II History, job ethics and career information. Evening Class 4768 lec 6:00pm - 9:10pm W STAFF	3.00 UNITS B 200B
PLUMBING 028 PLUMBING CODE I Plumbing mathematics and elementary drawings. Evening Class 4739 lec 6:00pm - 9:10pm T L. JONES	3.00 UNITS B 222
PLUMBING 029 PLUMBING CODE II Evening Class 4740 lec 6:00pm - 9:10pm Th L. JONES	3.00 UNITS B 222
PLUMBING 031 BACKFLOW PREVENTION DEVICES Evening Class 4744 lec 6:00pm - 6:45pm TTh K.S. FREIDENBERGER & lab 6:45pm - 9:10pm TTh K.S. FREIDENBERGER	3.00 UNITS B 200B B 200B
PLUMBING 033 PLUMBING CODE III Evening Class 4748 lec 6:00pm - 9:10pm F C. LUNT	3.00 UNITS B 222
PLUMBING 111 INTRODUCTION TO PLUMBING 8174 lec 7:00am - 7:30am TTh STAFF & lab 9:15am - 12:25pm TTh STAFF	3.00 UNITS B 250 B 352
PLUMBING 112 FUNDAMENTALS OF PLUMBING 8164 lec 7:40am - 9:05am TTh STAFF Evening Class 4745 lec 6:00pm - 9:10pm M R.W. YATES	3.00 UNITS B 352 B 250
PLUMBING 113 BASIC PLUMBING PRINCIPLES AND PRACTICES 8165 lec 7:00am - 8:05am MWF STAFF & lab 8:05am - 11:05am MWF STAFF	6.00 UNITS B 352 B 252
PLUMBING 121 WORKING DRAWINGS AND LAYOUT I 8166 lec 7:00am - 8:25am MW L. JONES	3.00 UNITS B 222
PLUMBING 122 PLUMBING MATHEMATICS AND PROCEDURES II 8167 lec 7:00am - 8:25am TTh L. JONES	3.00 UNITS B 222
PLUMBING 123 PLUMBING PRACTICES AND INSTALLATION 8168 lec 8:35am - 9:20am MW L. JONES & lab 9:20am - 11:40am MW L. JONES & lab 8:35am - 11:40am TTh L. JONES & lab 7:00am - 10:35am F L. JONES	6.00 UNITS B 222 B 200 B 200 B 200
PLUMBING 141 ADVANCE LAYOUT AND PROCEDURES 8169 lec 7:00am - 8:25am MW C.R. DEAN	3.00 UNITS B 200B

PLUMBING 142 SERVICING OF PLUMBING FIXTURES AND APPLIANCES 8170 lec 8:35am - 9:20am MW C.R. DEAN & lab 9:20am - 11:45am MW C.R. DEAN	3.00 UNITS B 200B B 200B
PLUMBING 143 PLUMBING CODE I 8171 lec 7:00am - 7:45am TTh STAFF & lab 7:45am - 10:10am TTh STAFF	3.00 UNITS B 200B B 200
PLUMBING 144 SPECIAL PURPOSES INSTALLATION 8172 lec 10:20am - 11:45am TTh STAFF & lab 7:00am - 10:10am F STAFF	3.00 UNITS B 222 B 200
PLUMBING 941 COOPERATIVE EDUCATION - PLUMBING 9160 lec 4:25 hrs/wk TBA STAFF	4.00 UNITS D 236

➤ See page 73 for details and meeting times.

POLITICAL SCIENCE

POLITICAL SCIENCE 001 THE GOVERNMENT OF THE UNITED STATES (UC:CSU) 1030 lec 8:35am - 10:00am MW S. SANCHEZ 1031 lec 10:10am - 11:35am TTh P.Y. WANG 1033 lec 11:45am - 1:10pm TTh D. ROMERO 7972 lec 3:30 hrs/wk TBA J.P. TABAKIAN	3.00 UNITS F 224 E 216 F 223 ON LINE
--	--

➤ Please visit the online program homepage at <http://moodle.lattc.edu> prior to the start of class for directions, or see pages 70-72 of this schedule for more information.

Evening Class
3631 lec 6:00pm - 9:10pm T L.B. COULTER F 228

Political Science I is also offered through Instructional Television (ITV) Program. For registration and orientation, see Ad on page 75

PROCESS PLANT TECHNOLOGY

PROCESS PLANT TECHNOLOGY 100 INTRODUCTION TO INDUSTRIAL PROCESS 6802 lec 8:45am - 10:20am MW G. ACERO ➤ NEW TECH SCHOOL, 1319 EAST 41ST, LOS ANGELES, CA 90011. Contact Diana Casas, 323-521-1290 6806 lec 10:25am - 11:50am TTh G. ACERO ➤ NEW TECH SCHOOL, 1319 EAST 41ST, LOS ANGELES, CA 90011. Contact Diana Casas, 323-521-1290	3.00 UNITS NEW TECH NEW TECH
PROCESS PLANT TECHNOLOGY 102 PROCESS MEASUREMENT AND CONTROL FUNDAMENTALS 1643 lec 7:00am - 10:10am W J. CHAPMAN Evening Class 4082 lec 6:00pm - 9:10pm W S.I. OKEKE	3.00 UNITS K 424 K 424
PROCESS PLANT TECHNOLOGY 104 INTRODUCTION TO PROCESS PLANT SAFETY Evening Class 4087 lec 6:00pm - 9:10pm M R.M. BABAJIDE	3.00 UNITS K 424

PROCESS PLANT TECHNOLOGY 200					3.00 UNITS
PETROLEUM REFINING FUNDAMENTALS					
1646	lec	7:00am - 10:10am	Th	C. SUTTON	K 424
Evening Class					
4083	lec	6:00pm - 9:10pm	Th	S.I. OKEKE	K 424

PSYCHOLOGY

PSYCHOLOGY 001					3.00 UNITS
GENERAL PSYCHOLOGY I (UC:CSU)					
1041	lec	8:35am - 10:00am	MW	M.D. WALLACH	F 228
1042	lec	10:10am - 11:35am	MW	L.S. KORITZKE	F 223
1043	lec	8:35am - 10:00am	TTh	M.J. BENTLEY	F 223
1044	lec	10:10am - 11:35am	TTh	R.W. ESSEX	F 209
1045	lec	11:45am - 1:10pm	TTh	R.W. ESSEX	F 209
7975	lec	3:15 hrs/wk	TBA	L.S. KORITZKE	ON LINE
➤ Please visit the online program homepage at http://moodle.latic.edu prior to the start of class for directions, or see pages 70-72 of this schedule for more information.					
Evening Class					
3640	lec	6:00pm - 9:10pm	M	R.W. ESSEX	F 209
6811	lec	3:45pm - 5:25pm	TTh	STAFF	COLL READ
➤ College Ready Academy #4, 644 West 17th Street, Los Angeles, CA 90015					

Psychology I is also offered through Instructional Television (ITV) Program. For registration and orientation, see Ad on page 75

PSYCHOLOGY 002					3.00 UNITS
GENERAL PSYCHOLOGY II (UC:CSU)					
Evening Class					
3642	lec	6:00pm - 9:10pm	W	R.W. ESSEX	F 209

PSYCHOLOGY 032					3.00 UNITS
PSYCHOLOGY OF WOMEN (UC:CSU)					
7976	lec	3:15 hrs/wk	TBA	L.S. KORITZKE	ON LINE
➤ Please visit the online program homepage at http://moodle.latic.edu prior to the start of class for directions, or see pages 70-72 of this schedule for more information.					

PSYCHOLOGY 041					3.00 UNITS
LIFE-SPAN PSYCHOLOGY: FROM INFANCY TO OLD AGE (UC:CSU)					
Prerequisite: Psychology 1.					
1048	lec	10:10am - 11:35am	MW	R.W. ESSEX	F 209
1049	lec	11:45am - 1:10pm	MW	L.S. KORITZKE	K 222
7981	lec	3:15 hrs/wk	TBA	L.S. KORITZKE	ON LINE
➤ Please visit the online program homepage at http://moodle.latic.edu prior to the start of class for directions, or see pages 70-72 of this schedule for more information.					
Evening Class					
3645	lec	6:00pm - 9:10pm	T	R.W. ESSEX	F 209

Psychology 41 is also offered through Instructional Television (ITV) Program. For registration and orientation, see Ad on page 75

PUBLIC RELATIONS

PUBLIC RELATIONS 001					3.00 UNITS
PRINCIPLES OF PUBLIC RELATIONS (CSU)					
7956	lec	3:15 hrs/wk	TBA	M.C. BESSLER	ON LINE
➤ Please visit the online program homepage at http://moodle.latic.edu prior to the start of class for directions, or see pages 70-72 of this schedule for more information.					

REAL ESTATE

REAL ESTATE 001					3.00 UNITS
REAL ESTATE PRINCIPLES (CSU)					
0259	lec	1:00pm - 4:10pm	M	M.D. TAYLOR	K 322
Evening Class					
3065	lec	6:00pm - 9:10pm	M	M.D. TAYLOR	K 322
REAL ESTATE 005					3.00 UNITS
LEGAL ASPECTS OF REAL ESTATE I (CSU)					
Evening Class					
3066	lec	6:00pm - 9:10pm	W	M.D. TAYLOR	K 322
REAL ESTATE 009					3.00 UNITS
REAL ESTATE APPRAISAL I (CSU)					
0252	lec	8:00am - 2:30pm	Th	M.D. TAYLOR	K 322
<i>(8 Week Class - Starts 2/8/2010, Ends 4/9/2010)</i>					
REAL ESTATE 010					3.00 UNITS
REAL ESTATE APPRAISAL II (CSU)					
0257	lec	8:00am - 2:30pm	T	M.D. TAYLOR	K 322
<i>(8 Week Class - Starts 4/12/2010, Ends 6/7/2010)</i>					

REFRIGERATION & AIR CONDITIONING MECHANICS

REFRIGERATION & AIR CONDITIONING MECHANICS 111					3.00 UNITS
FUNDAMENTALS OF REFRIGERATION					
8300	lec	7:00am - 10:10am	M	G. CIOFFI	B 250
REFRIGERATION & AIR CONDITIONING MECHANICS 113					3.00 UNITS
REFRIGERATION COMPONENT CONSTRUCTION					
8301	lab	7:00am - 12:05pm	TTh	G. CIOFFI	B 238
REFRIGERATION & AIR CONDITIONING MECHANICS 114					3.00 UNITS
REFRIGERATION MAINTENANCE PROCEDURES					
8302	lab	7:00am - 12:05pm	WF	G. CIOFFI	B 238
REFRIGERATION & AIR CONDITIONING MECHANICS 123					3.00 UNITS
PIPE AND TUBE JOINING PROCESSES					
8304	lab	7:00am - 12:05pm	MW	C.J. BARNETT	B 237
REFRIGERATION & AIR CONDITIONING MECHANICS 124					3.00 UNITS
REFRIGERATION ELECTRICAL CIRCUITS AND CONTROLS					
8305	lab	7:00am - 12:05pm	TTh	C.J. BARNETT	B 237
REFRIGERATION & AIR CONDITIONING MECHANICS 125					3.00 UNITS
REFRIGERATION SYSTEM COMPONENTS					
8306	lec	7:00am - 10:10am	F	C.J. BARNETT	B 233
REFRIGERATION & AIR CONDITIONING MECHANICS 133					3.00 UNITS
REFRIGERATION SERVICE PROCEDURES I					
8308	lab	7:00am - 12:05pm	MW	M.R. NEEDHAM	B 204
REFRIGERATION & AIR CONDITIONING MECHANICS 134					3.00 UNITS
SERVICE FOR AIR CONDITIONING EQUIPMENT I					
8309	lab	7:00am - 12:05pm	TTh	M.R. NEEDHAM	B 204
REFRIGERATION & AIR CONDITIONING MECHANICS 135					3.00 UNITS
AIR CONDITIONING AND REFRIGERATION					
8310	lec	7:00am - 10:10am	F	M.R. NEEDHAM	B 203
REFRIGERATION & AIR CONDITIONING MECHANICS 141					3.00 UNITS
APPLIED REFRIGERATION AND AIR CONDITIONING PRINCIPLES					
8311	lec	7:00am - 10:10am	F	K. DOZIER	B 232

REFRIGERATION & AIR CONDITIONING MECHANICS 143 3.00 UNITS
REFRIGERATION SERVICING PROCEDURES II

8312 lab 7:00am - 12:05pm MW K. DOZIER B 221

REFRIGERATION & AIR CONDITIONING MECHANICS 145 3.00 UNITS
AIR CONDITIONING AND REFRIGERATION MECHANICS

8313 lab 7:00am - 12:05pm TTh K. DOZIER B 221

REFRIGERATION & AIR CONDITIONING MECHANICS 160 4.00 UNITS
REFRIGERATION SYSTEM PRINCIPLES AND PRACTICES4784 lec 8:00am - 10:30am S M.R. NEEDHAM B 233
& lab 10:30am - 3:40pm S M.R. NEEDHAM B 233**REFRIGERATION & AIR CONDITIONING MECHANICS 161** 4.00 UNITS
AIR CONDITIONING SYSTEM PRINCIPLES AND PRACTICES**Evening Class**4767 lec 6:00pm - 7:10pm MW P.B. KAHNG B 203
& lab 7:10pm - 9:40pm MW P.B. KAHNG B 204**REFRIGERATION & AIR CONDITIONING MECHANICS 162** 4.00 UNITS
PIPING PRINCIPLES AND PRACTICES**Evening Class**4774 lec 6:00pm - 7:10pm TTh B.R. CORBIN B 237
& lab 7:10pm - 9:40pm TTh B.R. CORBIN B 237**REFRIGERATION & AIR CONDITIONING MECHANICS 165** 4.00 UNITS
THERMAL ENERGY STORAGE/HEAT RECOVERY**Evening Class**4775 lec 6:00pm - 7:15pm MW A.P. DATIS B 237
& lab 7:15pm - 9:40pm MW A.P. DATIS B 237**REFRIGERATION & AIR CONDITIONING MECHANICS 177** 3.00 UNITS
HEATING AND AIR CONDITIONING II**Evening Class**

4757 lec 6:00pm - 9:10pm T C.J. BARNETT B 233

REFRIGERATION & AIR CONDITIONING MECHANICS 187 3.00 UNITS
SERVICING I**Evening Class**

4761 lec 6:00pm - 9:10pm Th C.J. BARNETT B 233

REFRIGERATION & AIR CONDITIONING MECHANICS 202 3.00 UNITS
REFRIGERATION FUNDAMENTALS (CSU)**Evening Class**

4752 lec 6:00pm - 9:10pm W A. ESPINOZA B 232

REFRIGERATION & AIR CONDITIONING MECHANICS 203 3.00 UNITS
COMPRESSION SYSTEMS OF REFRIGERATION (CSU)**Evening Class**

4753 lec 6:00pm - 9:10pm W P.A. BRADY B 222

REFRIGERATION & AIR CONDITIONING MECHANICS 204 3.00 UNITS
FUNCTIONS AND COMPRESSION SYSTEM COMPONENTS**Evening Class**

4754 lec 6:00pm - 9:10pm Th G.E. ALLEN B 250

REFRIGERATION & AIR CONDITIONING MECHANICS 208 4.00 UNITS
REFRIGERENT MANAGEMENT - EPA SECTION 608 CERTIFICATION (CSU)

7866 lec 4:20 hrs/wk TBA G. CIOFFI ON LINE

> Please visit the online program homepage at <http://moodle.lattc.edu> prior to the start of class for directions, or see pages 70-72 of this schedule for more information.**REFRIGERATION & AIR CONDITIONING MECHANICS 941** 4.00 UNITS
COOPERATIVE EDUCATION-REFRIGERATION & AIR CONDITIONING MECHANICS

9192 lec 4:25 hrs/wk TBA STAFF D 236

> See page 73 for details and meeting times.

RESTAURANT MANAGEMENT**RESTAURANT MANAGEMENT 100** 3.00 UNITS

7522 lec 1:30pm - 4:30pm T R.B. WEMISCHNER H 103

SIGN GRAPHICS**SIGN GRAPHICS 101** 10.00 UNIT
INDIVIDUAL LETTERING7215 lec 7:00am - 8:00am TWThF R.T. GUTHRIE H 204
& lab 8:00am - 12:40pm TWThF R.T. GUTHRIE H 204**SIGN GRAPHICS 102** 10.00 UNIT
EXTERIOR DISPLAY SIGNS

Prerequisite: SGNRPH 101.

7216 lec 7:00am - 8:00am TWThF R.T. GUTHRIE H 204
& lab 8:00am - 12:40pm TWThF R.T. GUTHRIE H 204**SIGN GRAPHICS 103** 10.00 UNIT
WINDOW SIGNS

Prerequisite: SGNRPH 102.

7217 lec 7:00am - 8:00am TWThF R.T. GUTHRIE H 204
& lab 8:00am - 12:40pm TWThF R.T. GUTHRIE H 204**SIGN GRAPHICS 104** 10.00 UNIT
ADVANCE COMPUTER & DESIGN

Prerequisite: SGNRPH 103.

7218 lec 7:00am - 8:00am TWThF R.T. GUTHRIE H 204
& lab 8:00am - 12:40pm TWThF R.T. GUTHRIE H 204**SIGN GRAPHICS 185** 1.00 UNIT
DIRECTED STUDY - SIGN GRAPHICS

7219 lec 1:05 hrs/wk TBA R.T. GUTHRIE H 204

SIGN GRAPHICS 203 3.00 UNITS
SILK SCREEN PROCESSING I

7222 lec 8:00am - 2:45pm S B.T. JOHNSON H 230

Evening Class

4360 lab 5:30pm - 9:00pm TTh P. GOLDWHITE H 230

SIGN GRAPHICS 204 2.00 UNITS
SILK SCREEN PROCESSING II

7223 lab 8:00am - 2:45pm S B.T. JOHNSON H 230

SIGN GRAPHICS 285 2.00 UNITS
DIRECTED STUDY - SIGN GRAPHICS

7220 lec 2:15 hrs/wk TBA R.T. GUTHRIE H 204

SIGN GRAPHICS 385 3.00 UNITS
DIRECTED STUDY - SIGN GRAPHICS

7221 lec 3:15 hrs/wk TBA R.T. GUTHRIE H 204

SOCIOLOGY**SOCIOLOGY 001** 3.00 UNITS**INTRODUCTION TO SOCIOLOGY (UC:CSU)**

1051 lec 10:10am - 11:35am MW F. MCCLAIN F 210

1053 lec 11:45am - 1:10pm MW F. MCCLAIN F 210

1054 lec 10:10am - 11:35am TTh F. MCCLAIN F 210

1055 lec 11:45am - 1:10pm TTh F. MCCLAIN F 210

6813 lec 1:30pm - 3:10pm MTh STAFF F 210

6815	lec	1:30pm - 3:10pm	MTh	STAFF	F 221
7983	lec	3:10 hrs/wk	TBA	J.A. GARCIA	ON LINE
<i>(13 Week Class - Starts 3/15/2010, Ends 6/7/2010)</i>					
➤ Please visit the online program homepage at http://moodle.lattc.edu prior to the start of class for directions, or see pages 70-72 of this schedule for more information.					
Evening Class					
3665	lec	6:00pm - 9:10pm	Th	V.Z. PAYNE	F 223
6812	lec	3:45pm - 5:25pm	TTh	STAFF	COLL READ
➤ College Ready Academy #4, 644 West 17th Street, Los Angeles, CA 90015					

Sociology I is also offered through Instructional Television (ITV) Program. For registration and orientation, see Ad on page 75

SOCIOLOGY 002		3.00 UNITS	
AMERICAN SOCIAL PROBLEMS (UC:CSU)			
1058	lec	8:35am - 10:00am	TTh F. MCCLAIN F 210
SOCIOLOGY 028		3.00 UNITS	
THE FAMILY: A SOCIOLOGICAL APPROACH (UC:CSU)			
1059	lec	8:35am - 10:00am	MW F. MCCLAIN F 210

SOLID WASTE MANAGEMENT TECHNOLOGY

SOLID WASTE MANAGEMENT TECHNOLOGY 107		3.00 UNITS	
SPECIAL WASTES AND ENVIRONMENTAL ISSUES			
Evening Class			
4178	lec	6:00pm - 9:10pm	M P.C. BLOUNT K 406
SOLID WASTE MANAGEMENT TECHNOLOGY 941		4.00 UNITS	
COOPERATIVE EDUCATION - SOLID WASTE MANAGEMENT TECHNOLOGY			
9212	lab	4:25 hrs/wk	TBA STAFF D 236
➤ See page 73 for details and meeting times.			

SPANISH

SPANISH 001		5.00 UNITS	
ELEMENTARY SPANISH I (UC:CSU)			
1530	lec	8:35am - 9:50am	MTWTh H.C. QUINONES K 366
1531	lec	10:10am - 11:20am	MTWTh H.C. QUINONES K 366
1532	lec	11:45am - 12:55pm	MTWTh H.C. QUINONES K 366
1546	lec	9:00am - 2:20pm	S M. LINARES K 364
Evening Class			
3866	lec	6:45pm - 9:15pm	MW M.M. DRAKE K 364
6860	lec	3:45pm - 6:15pm	TTh M.M. DRAKE K 364
SPANISH 002		5.00 UNITS	
ELEMENTARY SPANISH II (UC:CSU)			
Prerequisite: SPANISH 1.			
1534	lec	10:10am - 11:20am	MTWTh P. ROLDAN K 364
1548	lec	8:35am - 9:50am	TTh R. PALACIOS OCHOA K 364
Evening Class			
3865	lec	6:45pm - 9:15pm	TTh R. ROSS K 364
3867	lec	6:45pm - 9:15pm	MW R. BUSCAGLIA K 364
SPANISH 021		3.00 UNITS	
FUNDAMENTALS OF SPANISH I (UC:CSU)			
Evening Class			
3869	lec	5:00pm - 6:20pm	MW R. BUSCAGLIA K 366
SPANISH 022		3.00 UNITS	
FUNDAMENTALS OF SPANISH II (UC:CSU)			
Evening Class			
3868	lec	5:00pm - 6:15pm	TTh R. BUSCAGLIA K 366

SPANISH 035		5.00 UNITS	
SPANISH FOR SPANISH SPEAKERS I (UC:CSU)			
Evening Class			
3872	lec	6:45pm - 9:15pm	TTh R. BUSCAGLIA K 366
SPANISH 036		5.00 UNITS	
SPANISH FOR SPANISH SPEAKERS II (UC:CSU)			
Evening Class			
6861	lec	6:45pm - 9:15pm	TTh R. BUSCAGLIA K 366

Spanish Course Sequence

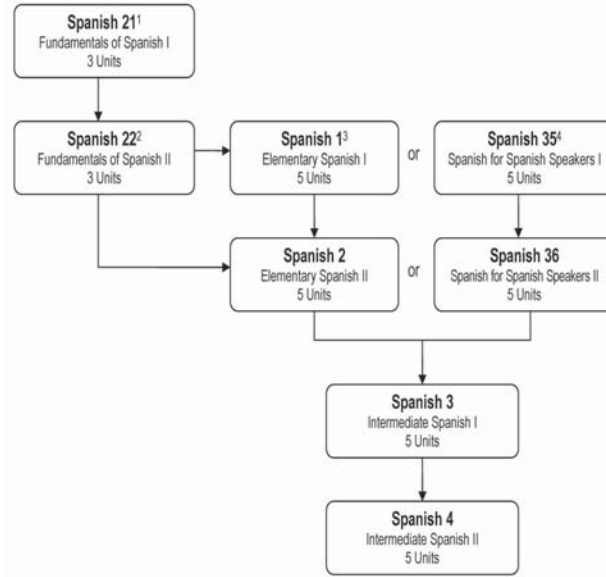

- *Spanish 21* can be taken as a first step to acquire the basic to do well in "Spanish 1" or as part of the sequence "Spanish 21 - Spanish 22".
- Completion of the sequence "Spanish 21 - Spanish 22" fulfills the requirement for "Spanish 1". This sequence is recommended for students who do not have the time to embark in a 5 unit class all at once.
- *Spanish 1* and "Spanish 2" are recommended for non-native speakers.
- *Spanish 35* and "Spanish 36" are recommended for heritage-language speakers (also known as native-speakers or bilingual speakers.)

SPEECH

SPEECH 101		3.00 UNITS	
ORAL COMMUNICATION I (UC:CSU)			
1125	lec	7:00am - 8:25am	TTh D.A. WOOD F 211
1127	lec	8:35am - 10:00am	MW J.J. GLAVAN K 368
1128	lec	10:10am - 11:35am	MW J.J. GLAVAN K 368
1129	lec	11:45am - 1:10pm	MW J.J. GLAVAN K 368
1130	lec	8:35am - 10:00am	TTh D.A. WOOD F 224
1131	lec	10:10am - 11:35am	TTh J.J. GLAVAN K 368
1132	lec	8:35am - 10:00am	TTh J.J. GLAVAN K 368
6878	lec	1:30pm - 3:05pm	WF A.C. BORNE K 368
Evening Class			
6886	lec	3:45pm - 5:35pm	TTh C.V. MCNAMARA COLL READ
➤ College Ready Academy #4, 644 West 17th Street, Los Angeles, CA 90015			
<i>(14 Week Class - Starts 3/2/2010, Ends 6/7/2010)</i>			
3759	lec	4:35pm - 7:45pm	F J.C. MOCK K 368
3825	lec	6:00pm - 9:10pm	T J.C. MOCK K 368
3760	lec	6:00pm - 9:10pm	M J.C. MOCK K 368
3762	lec	6:00pm - 9:10pm	W J.C. MOCK K 368
3763	lec	6:00pm - 9:10pm	Th J.C. MOCK K 368

SUPERVISION

SUPERVISION 001 3.00 UNITS

ELEMENTS OF SUPERVISION (CSU)

7831 lec 3:15 hrs/wk TBA M.C. BESSLER ON LINE

➤ Please visit the online program homepage at <http://moodle.lattc.edu> prior to the start of class for directions, or see pages 70-72 of this schedule for more information.

Evening Class

3073 lec 6:00pm - 9:10pm W E.R. JOHNSON K 204

SUPERVISION 003 3.00 UNITS

HUMAN RELATIONS (DEVELOPING SUPERVISORY LEADERSHIP)

Evening Class

3074 lec 6:00pm - 9:10pm M R. ROBERTS K 302

SUPERVISION 011 3.00 UNITS

ORAL COMMUNICATIONS

7845 lec 3:15 hrs/wk TBA M.C. BESSLER ON LINE

➤ Mandatory class oral presentation in person is required. Schedule times will be posted at the start of the Spring semester along with the room number. Moodle orientations are strongly recommended. Check the current online schedule for meeting times and locations.

➤ Please visit the online program homepage at <http://moodle.lattc.edu> prior to the start of class for directions, or see pages 70-72 of this schedule for more information.

SUPPLY WATER TECHNOLOGY

SUPPLY WATER TECHNOLOGY 005 3.00 UNITS

WATER PURIFICATION II (POTABLE WATER)

Evening Class

4112 lec 6:00pm - 9:10pm W A. AMIR TEYMOORI K 406

SUPPLY WATER TECHNOLOGY 941 4.00 UNITS

COOPERATIVE EDUCATION - SUPPLY WATER TECHNOLOGY

9248 lec 4:25 hrs/wk TBA STAFF D 236

➤ See page 73 for details and meeting times.

TAILORING

TAILORING 185 1.00 UNIT

DIRECTED STUDY - TAILORING

7234 lec 1:05 hrs/wk TBA B.S. TORDA D 234

Evening Class

4350 lec 1:05 hrs/wk TBA N.G. IAPAOLLO D 105

TAILORING 226 2.00 UNITS

TAILORING AND DESIGN I

Evening Class

4340 lab 6:00pm - 9:10pm MW N.G. IAPAOLLO D 105

TAILORING 227 2.00 UNITS

TAILORING AND DESIGN II

Evening Class

4341 lab 6:00pm - 9:10pm MW N.G. IAPAOLLO D 105

TAILORING 228 2.00 UNITS

TAILORING AND DESIGN III

Evening Class

4342 lab 6:00pm - 9:10pm MW N.G. IAPAOLLO D 105

TAILORING 229 2.00 UNITS

TAILORING AND DESIGN IV

Evening Class

4343 lab 6:00pm - 9:10pm MW N.G. IAPAOLLO D 105

TAILORING 233 2.00 UNITS

MEN'S CUSTOM PATTERN DRAFTING AND DESIGN I

7228 lab 8:35am - 3:05pm S B.S. TORDA D 234

TAILORING 234 2.00 UNITS

MEN'S CUSTOM PATTERN DRAFTING AND DESIGN II

7229 lab 8:35am - 3:05pm S B.S. TORDA D 234

TAILORING 285 2.00 UNITS

DIRECTED STUDY - TAILORING

7235 lec 2:15 hrs/wk TBA B.S. TORDA D 234

Evening Class

4351 lec 2:15 hrs/wk TBA N.G. IAPAOLLO D 105

TAILORING 385 3.00 UNITS

DIRECTED STUDY - TAILORING

7236 lec 3:15 hrs/wk TBA B.S. TORDA D 234

Evening Class

4352 lec 3:15 hrs/wk TBA N.G. IAPAOLLO D 105

THEATER

THEATER 270 3.00 UNITS

BEGINNING ACTING (UC:CSU)

1581 lec 11:45am - 1:15pm TTh E. HARMETZ F 227

VISUAL COMMUNICATIONS

VISUAL COMMUNICATIONS 100 2.00 UNITS

GRAPHIC DESIGN I (CSU)

7253 lec 7:00am - 7:45am TW R.N. HUBBARD H 238

& lab 7:45am - 12:05pm TW R.N. HUBBARD H 238

(8 Week Class - Starts 2/8/2010, Ends 4/9/2010)

VISUAL COMMUNICATIONS 103 2.00 UNITS

BASIC COMPUTER SYSTEMS (CSU)

7254 lec 7:00am - 7:45am ThF G. EVANS H 209

& lab 7:45am - 12:05pm ThF G. EVANS H 209

(8 Week Class - Starts 2/8/2010, Ends 4/9/2010)

VISUAL COMMUNICATIONS 105 2.00 UNITS

DIGITAL PREPRESS I (CSU)

7255 lec 7:00am - 7:45am TW G. EVANS H 230

& lab 7:45am - 12:05pm TW G. EVANS H 230

(8 Week Class - Starts 4/12/2010, Ends 6/7/2010)

VISUAL COMMUNICATIONS 106 2.00 UNITS

DRAWING I (CSU)

7256 lec 7:00am - 7:45am ThF R.N. HUBBARD H 220

& lab 7:45am - 12:05pm ThF R.N. HUBBARD H 220

(8 Week Class - Starts 4/12/2010, Ends 6/7/2010)

VISUAL COMMUNICATIONS 112 2.00 UNITS

DIGITAL PREPRESS II (CSU)

7258 lec 7:00am - 7:45am TW G. EVANS H 209

& lab 7:45am - 12:05pm TW G. EVANS H 209

(8 Week Class - Starts 2/8/2010, Ends 4/9/2010)

VISUAL COMMUNICATIONS 114 **2.00 UNITS**
DIGITAL TYPESETTING (CSU)

7259 lec 7:00am - 7:45am ThF C.J. RODRIGUEZ H 208
 & lab 7:45am - 12:05pm ThF C.J. RODRIGUEZ H 208
(8 Week Class - Starts 2/8/2010, Ends 4/9/2010)

VISUAL COMMUNICATIONS 115 **2.00 UNITS**
GRAPHIC DESIGN II (CSU)

7260 lec 7:00am - 7:45am TW F.H. MORRIS H 208
 & lab 7:45am - 12:05pm TW F.H. MORRIS H 208
(8 Week Class - Starts 4/12/2010, Ends 6/7/2010)

VISUAL COMMUNICATIONS 116 **2.00 UNITS**
THREE-DIMENSIONAL PACKAGE DESIGN (CSU)

7261 lec 7:00am - 7:45am ThF F.H. MORRIS H 208
 & lab 7:45am - 12:05pm ThF F.H. MORRIS H 208
(8 Week Class - Starts 4/12/2010, Ends 6/7/2010)

VISUAL COMMUNICATIONS 118 **2.00 UNITS**
DIGITAL DRAWING (CSU)

7262 lec 7:00am - 8:00am M R.N. HUBBARD H 209
 & lab 8:00am - 11:30am M R.N. HUBBARD H 209

VISUAL COMMUNICATIONS 120 **2.00 UNITS**
DRAWING II (CSU)

7264 lec 7:00am - 7:45am TW W.T. ROBLES H 208
 & lab 7:45am - 12:05pm TW W.T. ROBLES H 208
(8 Week Class - Starts 2/8/2010, Ends 4/9/2010)

VISUAL COMMUNICATIONS 124 **2.00 UNITS**
COMPUTER ILLUSTRATION I (CSU)

7265 lec 7:00am - 7:45am ThF R.N. HUBBARD H 238
 & lab 7:45am - 12:05pm ThF R.N. HUBBARD H 238
(8 Week Class - Starts 2/8/2010, Ends 4/9/2010)

VISUAL COMMUNICATIONS 126 **2.00 UNITS**
PORTFOLIO DEVELOPMENT I (CSU)

7266 lec 7:00am - 7:45am TW R.N. HUBBARD H 220
 & lab 7:45am - 12:05pm TW R.N. HUBBARD H 220
(8 Week Class - Starts 4/12/2010, Ends 6/7/2010)

VISUAL COMMUNICATIONS 127 **2.00 UNITS**
DIGITAL PREPRESS III (CSU)

7267 lec 7:00am - 7:30am ThF G. EVANS H 238
 & lab 7:30am - 12:00pm ThF G. EVANS H 238
(8 Week Class - Starts 4/12/2010, Ends 6/7/2010)

VISUAL COMMUNICATIONS 129 **2.00 UNITS**
DIGITAL PHOTO MANIPULATION (CSU)

7269 lec 12:15pm - 1:15pm T R.N. HUBBARD H 238
 & lab 1:15pm - 2:30pm Th R.N. HUBBARD H 238

VISUAL COMMUNICATIONS 130 **2.00 UNITS**
DRAWING III (CSU)

7270 lec 7:00am - 7:45am TW W.T. ROBLES H 208
 & lab 7:45am - 12:05pm TW W.T. ROBLES H 208
(8 Week Class - Starts 2/8/2010, Ends 4/9/2010)

VISUAL COMMUNICATIONS 131 **2.00 UNITS**
COMPUTER ILLUSTRATION II (CSU)

7271 lec 7:00am - 7:45am ThF R.N. HUBBARD H 238
 & lab 7:45am - 12:05pm ThF R.N. HUBBARD H 238
(8 Week Class - Starts 2/8/2010, Ends 4/9/2010)

VISUAL COMMUNICATIONS 132 **2.00 UNITS**
PORTFOLIO DEVELOPMENT II (CSU)

7272 lec 7:00am - 7:45am TW R.N. HUBBARD H 220
 & lab 7:45am - 12:05pm TW R.N. HUBBARD H 220
(8 Week Class - Starts 4/12/2010, Ends 6/7/2010)

VISUAL COMMUNICATIONS 133 **2.00 UNITS**
DIGITAL PORTFOLIO PREPARATION (CSU)

7273 lec 7:00am - 7:30am ThF G. EVANS H 209
 & lab 7:30am - 12:00pm ThF G. EVANS H 209
(8 Week Class - Starts 4/12/2010, Ends 6/7/2010)

VISUAL COMMUNICATIONS 135 **2.00 UNITS**
WEB PAGE GRAPHICS ON THE MACINTOSH (CSU)

7274 lec 8:00am - 9:00am M G. EVANS H 238
 & lab 9:00am - 1:20pm M G. EVANS H 238

VISUAL COMMUNICATIONS 185 **1.00 UNIT**
DIRECTED STUDY - VISUAL COMMUNICATIONS

7280 lec 1:05 hrs/wk TBA R.N. HUBBARD H 238

VISUAL COMMUNICATIONS 285 **2.00 UNITS**
DIRECTED STUDY - VISUAL COMMUNICATIONS

7282 lec 2:15 hrs/wk TBA R.N. HUBBARD H 238

VISUAL COMMUNICATIONS 385 **3.00 UNITS**
DIRECTED STUDY - VISUAL COMMUNICATIONS

7284 lec 3:15 hrs/wk TBA R.N. HUBBARD H 238

WASTEWATER TECHNOLOGY

WASTEWATER TECHNOLOGY 014 **3.00 UNITS**
WASTEWATER OPERATIONS III

Evening Class
 4122 lec 6:00pm - 9:10pm T M.A. ABDELAAL K 406

WASTEWATER TECHNOLOGY 017 **3.00 UNITS**
WASTEWATER OPERATIONS VI

Evening Class
 4125 lec 6:00pm - 9:10pm Th V. ABKIAN K 406

WASTEWATER TECHNOLOGY 941 **4.00 UNITS**
COOPERATIVE EDUCATION - WASTEWATER TECHNOLOGY

9252 lec 4:25 hrs/wk TBA STAFF D 236
 > See page 73 for details and meeting times.

WELDING GAS AND ELECTRIC

WELDING GAS AND ELECTRIC 111 **6.00 UNITS**
ACETYLENE WELDING, CUTTING AND BRAZING

8200 lec 7:00am - 8:25am F C.A. CHANCY F 156
 & lab 8:30am - 11:35am MTWThF C.A. CHANCY F 156

WELDING GAS AND ELECTRIC 112 **3.00 UNITS**
WELDING RELATED TECHNICAL INSTRUCTIONS I

8202 lec 11:35am - 1:35pm MW C.A. CHANCY F 150

WELDING GAS AND ELECTRIC 113 **3.00 UNITS**
APPLIED MATHEMATICS I

8203 lec 11:35am - 1:35pm TTh C.A. CHANCY F 150

WELDING GAS AND ELECTRIC 121 **6.00 UNITS**
ELECTRIC WELDING I

8220 lec 11:35am - 1:00pm F C.A. CHANCY F 156
 & lab 8:35am - 11:35am MTWThF C.A. CHANCY F 150

WELDING GAS AND ELECTRIC 124 **3.00 UNITS**
BLUEPRINT READING I

8221 lec 7:00am - 8:25am TTh C.A. CHANCY F 150

WELDING GAS AND ELECTRIC 125 **3.00 UNITS**
APPLIED MATHEMATICS II

8222 lec 7:00am - 8:25am MW C.A. CHANCY F 150

WELDING GAS AND ELECTRIC 131 ELECTRIC WELDING II		6.00 UNITS	
8223	lec 7:00am - 8:25am M	L.M. LEGOHN	F 151
&	lab 8:30am - 11:35am MTWThF	L.M. LEGOHN	F 156
WELDING GAS AND ELECTRIC 132 BLUEPRINT READING II		3.00 UNITS	
8224	lec 7:00am - 8:25am TTh	L.M. LEGOHN	F 151
WELDING GAS AND ELECTRIC 133 WELDING RELATED TECHNICAL INSTRUCTION III		3.00 UNITS	
8225	lec 7:00am - 8:25am WF	L.M. LEGOHN	F 151
WELDING GAS AND ELECTRIC 141 ELECTRIC WELDING III		6.00 UNITS	
8240	lec 11:35am - 1:00pm M	L.M. LEGOHN	F 151
&	lab 8:30am - 11:35am MTWThF	L.M. LEGOHN	F 156
WELDING GAS AND ELECTRIC 142 INERT GAS WELDING (TIG & MIG)		3.00 UNITS	
8241	lec 11:35am - 1:00pm TTh	L.M. LEGOHN	F 151
WELDING GAS AND ELECTRIC 143 WELDING RELATED TECHNICAL INSTRUCTION IV		3.00 UNITS	
8242	lec 11:35am - 1:00pm WF	L.M. LEGOHN	F 151
WELDING GAS AND ELECTRIC 200 METAL SCULPTURE II		3.00 UNITS	
Evening Class			
4808	lec 6:00pm - 6:50pm MW	R. NEWELL	F 151A
&	lab 6:50pm - 9:10pm MW	R. NEWELL	F 156
WELDING GAS AND ELECTRIC 201A WELDING-GAS AND ELECTRIC IA		1.00 UNIT	
Evening Class			
4802	lab 6:00pm - 9:10pm T	R. GALVEZ	F 156
WELDING GAS AND ELECTRIC 201B WELDING-GAS AND ELECTRIC IB		1.00 UNIT	
Evening Class			
4803	lab 6:00pm - 8:50pm Th	R. GALVEZ	F 156
4811	lab 6:00pm - 9:10pm T	R. GALVEZ	F 156
WELDING GAS AND ELECTRIC 202 WELDING-GAS AND ELECTRIC II		2.00 UNITS	
4810	lab 8:00am - 2:20pm S	C.A. CHANCY	F 156
WELDING GAS AND ELECTRIC 210 METAL SCULPTING LABORATORY		2.00 UNITS	
Evening Class			
4806	lab 6:00pm - 8:50pm MW	R. NEWELL	F 156
WELDING GAS AND ELECTRIC 941 COOPERATIVE EDUCATION - WELDING GAS AND ELECTRIC		4.00 UNITS	
9256	lab 4:25 hrs/wk TBA	STAFF	D 236

➤ See page 73 for details and meeting times.

NONCREDIT CLASSES

BASIC SKILLS (NONCREDIT)

BASIC SKILLS 002CE		0.00 UNIT	
BASIC ENGLISH SKILLS (NDA)			
8732	lec 8:30am - 10:05am MTWTh	STAFF	E 210
<i>(9 Week Class - Starts 2/8/2010, Ends 4/8/2010)</i>			
8733	lec 8:30am - 9:55am MTWTh	STAFF	E 210
<i>(8 Week Class - Starts 4/12/2010, Ends 6/3/2010)</i>			
Evening Class			
5735	lec 6:30pm - 8:35pm TTh	E. GUTIERREZ	E 206
<i>(13 Week Class - Starts 2/23/2010, Ends 5/20/2010)</i>			
BASIC SKILLS 023CE		0.00 UNIT	
COLLEGE AND SCHOLASTIC ASSESSMENT PREPARATION (NDA)			
8701	lec 8:30am - 11:05am MTWThF	STAFF	E 206
<i>(6 Week Class - Starts 2/8/2010, Ends 3/19/2010)</i>			
8702	lec 8:30am - 11:05am MTWThF	STAFF	E 208
<i>(6 Week Class - Starts 2/8/2010, Ends 3/19/2010)</i>			
8703	lec 12:00pm - 2:35pm MTWThF	STAFF	E 206
<i>(6 Week Class - Starts 2/8/2010, Ends 3/19/2010)</i>			
8704	lec 8:30am - 10:35am MTWThF	STAFF	E 206
<i>(8 Week Class - Starts 3/22/2010, Ends 5/14/2010)</i>			
8705	lec 8:30am - 10:35am MTWThF	STAFF	E 208
<i>(8 Week Class - Starts 3/22/2010, Ends 5/14/2010)</i>			
8706	lec 11:30am - 1:30pm MTWThF	STAFF	E 206
<i>(8 Week Class - Starts 3/22/2010, Ends 5/14/2010)</i>			
8723	lec 11:30am - 1:30pm MTWThF	STAFF	E 208
<i>(8 Week Class - Starts 3/22/2010, Ends 5/14/2010)</i>			
8725	lec 12:00pm - 2:35pm MTWThF	STAFF	E 208
<i>(6 Week Class - Starts 2/8/2010, Ends 3/19/2010)</i>			
8810	lec 9:00am - 12:05pm S	N.D. MARTINEZ	E 221
&	lec 1:00 hrs/wk TBA	A. TOM MIURA	E 221
<i>(16 Week Class - Starts 2/20/2010, Ends 6/7/2010)</i>			
8811	lec 2:45pm - 4:15pm MWThF	STAFF	ADAM MS
➤ John Adams Middle School, 151 West 30 th Street, Los Angeles, CA 90007.			
<i>(11 Week Class - Starts 3/1/2010, Ends 5/14/2010)</i>			
8812	lec 2:45pm - 4:15pm MWThF	J. CALDERON	ADAM MS
➤ John Adams Middle School, 151 West 30 th Street, Los Angeles, CA 90007.			
<i>(11 Week Class - Starts 3/1/2010, Ends 5/14/2010)</i>			
Evening Class			
5803	lec 6:00pm - 8:05pm TTh	STAFF	E 210
<i>(9 Week Class - Starts 3/15/2010, Ends 5/13/2010)</i>			
BASIC SKILLS 042CE		0.00 UNIT	
SOFTSKILL BASICS 1B - THE SUCCESSFUL JOB SEARCH (NDA)			
8762	lec 1:50 hrs/wk TBA	STAFF	U AW
<i>(5 Week Class - Starts 5/10/2010, Ends 6/7/2010)</i>			
➤ UAW, 3965 S. VERMONT AVENUE, LOS ANGELES, CA 90037			
Evening Class			
5766	lec 6:00pm - 8:50pm W	STAFF	E 210
<i>(3 Week Class - Starts 4/14/2010, Ends 4/28/2010)</i>			
BASIC SKILLS 043CE		0.00 UNIT	
SOFTSKILL BASICS 1C - PRE-EMPLOYMENT READINESS (NDA)			
8763	lec 1:50 hrs/wk TBA	STAFF	U AW
<i>(5 Week Class - Starts 5/10/2010, Ends 6/7/2010)</i>			
➤ UAW, 3965 S. VERMONT AVENUE, LOS ANGELES, CA 90037			
Evening Class			
5767	lec 6:00pm - 8:50pm W	STAFF	E 210
<i>(3 Week Class - Starts 5/5/2010, Ends 5/19/2010)</i>			
BASIC SKILLS 065CE		0.00 UNIT	
FINANCIAL LITERACY - CREDIT BASICS (NDA)			
Evening Class			
5765	lec 6:00pm - 10:15pm W	A. TOM MIURA	E 210
<i>(2 Week Class - Starts 3/24/2010, Ends 4/7/2010)</i>			
BASIC SKILLS 066CE		0.00 UNIT	
FINANCIAL LITERACY - PERSONAL MONEY MANAGEMENT (NDA)			
Evening Class			
5764	lec 6:00pm - 8:50pm W	A. TOM MIURA	E 210
<i>(3 Week Class - Starts 3/3/2010, Ends 3/17/2010)</i>			

ENGLISH AS A SECOND LANGUAGE (NONCREDIT)

ENGLISH AS A SECOND LANGUAGE 001CE	0.00 UNIT
ENGLISH AS A SECOND LANGUAGE - BEGINNING I (NDA)	
Evening Class	
5734 lec 6:30pm - 8:35pm MW R.A. VELASQUEZ	E 206
<i>(13 Week Class - Starts 2/22/2010, Ends 5/19/2010)</i>	
ENGLISH AS A SECOND LANGUAGE 006CE	0.00 UNIT
ENGLISH AS A SECOND LANGUAGE - 0 (NDA)	
8872 lec 10:00am - 1:10pm MW O. PIEROLA	SE IU
<i>(10 Week Class - Starts 2/8/2010, Ends 4/14/2010)</i>	
> SEIU, 1247 W. 74th Street, Los Angeles, CA 90017	
ENGLISH AS A SECOND LANGUAGE 007CE	0.00 UNIT
ENGLISH AS A SECOND LANGUAGE - 1 (NDA)	
8873 lec 10:00am - 1:15pm MW O. PIEROLA	SE IU
& lec 0:50 hrs/wk TBA O. PIEROLA	SE IU
<i>(8 Week Class - Starts 4/19/2010, Ends 6/2/2010)</i>	
> SEIU, 1247 W. 74th Street, Los Angeles, CA 90017	

ESL CIVICS

ESL CIVICS 001CE	0.00 UNIT
CIVICS (NDA)	
8876 lec 3:00pm - 6:20pm F F. IBARRA	SMB CCS
<i>(15 Week Class - Starts 2/19/2010, Ends 6/7/2010)</i>	
> Santa Monica Blvd. Community Charter School, 1022 Van Ness Avenue, Los Angeles, CA 90038. (323) 469-0971	

VOCATIONAL EDUCATION

VOCATIONAL EDUCATION 080CE	0.00 UNIT
BANK TELLER TRAINING (NDA)	
Evening Class	
5855 lec 6:00pm - 9:10pm TTh D. TRIGGS	E 210
<i>(11 Week Class - Starts 3/2/2010, Ends 5/20/2010)</i>	
VOCATIONAL EDUCATION 108CE	0.00 UNIT
COMPUTER TECHNOLOGY IN THE WORKPLACE (NDA)	
8851 lec 10:10am - 12:10pm MW O.K. KAPAKU	K 304
<i>(13 Week Class - Starts 2/22/2010, Ends 5/19/2010)</i>	
8852 lec 8:00am - 10:10am TTh V. EMERSON	K 208
<i>(13 Week Class - Starts 2/23/2010, Ends 5/20/2010)</i>	
8874 lec 10:00am - 1:00pm TTh O. PIEROLA	SE IU
<i>(10 Week Class - Starts 2/8/2010, Ends 4/14/2010)</i>	
> SEIU, 1247 W. 74th Street, Los Angeles, CA 90017	
8875 lec 10:00am - 1:00pm TTh O. PIEROLA	SE IU
& lec 0:50 hrs/wk TBA O. PIEROLA	SE IU
<i>(7 Week Class - Starts 4/20/2010, Ends 6/3/2010)</i>	
> SEIU, 1247 W. 74th Street, Los Angeles, CA 90017	

LATTC ON-LINE CLASSES

Special Dates for Online Students - Spring 2010 term:

Moodle Orientations will be given on:

- Tuesday, February 9th from 6 - 7:30 pm in L-110
- Tuesday, February 16th from 6-7:30 pm in L-110
- Saturday, February 20th from 9-11 am in L-110

Students who cannot attend orientation on campus can do video orientation.

What do I need in order to take an online class?

You'll need:

1. Computer access where you can regularly connect to the internet, plus
2. Sufficient computer skills to send/receive email and navigate the World Wide Web, and
3. A valid and currently-used email address in the SIS plus ability to log into the SIS.

How do I register for an online class?

1. If you're already a LATTC student, just enroll in your online class as you would any other, or
2. If you're new to LATTC, you'll need to enroll in the college first. Please go to <http://www.lacolleges.net/admissions/> to enroll online. Once you're enrolled in the college, you can proceed to register for your online class

I've registered. Now what ?

1. Go to the LATTC Online Program home page at <http://moodle.lattc.edu>
2. Download the Online Student Guide for your semester and read it carefully
3. Be sure to check if your class requires a campus edition of a textbook to coordinate with your online class. If you purchase the textbook at another campus, the key may not work for your LATTC class.
4. Check the Help for New Online Students link to get information on preparing your computer to take online classes. You'll need to be able to enable pop-ups and cookies on your computer in order for your online class to work.

Students who will be using the Moodle course management system should go to <http://moodle.lattc.edu> and follow the directions. Students who have a class using another course management system will need to either attend the scheduled class orientation or follow all directions on the class home page to set up the software.

Are there any special meetings, either on campus or online?

Each teacher has the right to request either on-campus or online meetings if they so desire. Some of the reasons they may choose to require these meetings is to ensure the student is who s/he claims to be and is the person actually doing the work and or tests. Or, teachers may require an on-campus meeting to provide materials or an orientation to help students get off to a great start.

Classes have already started. How do I get into an online class?

Send the instructor an email request to add the class. This email must come from the ID listed in the SIS. Include your name, student ID number, and the class name and section number in your email.

What if I need additional information?

You can contact the Online-Program Coordinator, Linda Delzeit-McIntyre, at 213/ 763-3733, or email her at delzeit@lattc.edu.



LATTC ON-LINE CLASSES

<u>COURSE INFORMATION</u>	<u>SECTION</u>	<u>UNITS</u>	<u>CMS</u>
Administration of Justice 14 – Report Writing for Peace Officers http://wellness.lattc.edu/elarton/AJ14.html (Feb. 8 to Jun. 7)	7878	3	M
Anthropology 101 – Human Biological Evolution (Physical Anthropology) http://wellness.lattc.edu/phuld/anthro101.html (Feb. 8 to Jun. 7)	7971	3	M
Art 101 – Survey of Art History I http://wellness.lattc.edu/online/art101.html (Feb. 8 to Jun. 7) http://wellness.lattc.edu/online/art101.html (April 5 to Jun. 7)	7940 7939	3	M
Art 104 – Art Appreciation II http://wellness.lattc.edu/online/art104.html (Feb. 8 to Jun. 7)	7944	3	M
CAOT 82 – Microcomputer Software Survey in the Office http://wellness.lattc.edu/online/caot82.html (Feb. 8 to Jun. 7)	7959	3	M
CAOT 84 – Microcomputer Office Applications: Word Processing http://wellness.lattc.edu/online/caot84.html (Feb. 8 to Jun. 7)	7962	3	M
CAOT 85 – Microcomputer Office Applications: Spreadsheet http://wellness.lattc.edu/online/caot85.html (Feb. 8 to Jun. 7)	7863	3	M
CAOT 133 – How to Succeed in an Online Course http://wellness.lattc.edu/online/caot133.html (Feb. 8 to Mar. 19)	7960	1	M
Child Development 001 – Child Growth and Development http://wellness.lattc.edu/online/ChildDev1.html (Feb. 8 to Jun. 7)	7931	3	M
English 28 – Intermediate Reading and Composition **[AT] and/or [PR]** http://wellness.lattc.edu/gangelvasquez/english28.html (Feb. 8 to Jun. 7)	7946	3	M
English 101 – College Reading and Composition I **[AT] and/or [PR]** http://wellness.lattc.edu/lmoreno/english101.html (Feb. 8 to Jun. 7)	7947	3	M
English 102 – College Reading and Composition II **[AT] and/or [PR]** http://wellness.lattc.edu/lmoreno/english102.html (Feb. 8 to Jun. 7)	7948	3	M
English 103 – Composition and Critical Thinking **[PR]** http://wellness.lattc.edu/lmoreno/english103.html (Feb. 8 to Jun. 7)	7943	3	M
English 206 – English Literature II **[AT] and/or [PR]** http://wellness.lattc.edu/lmoreno/english206.html (Feb. 8 to Jun. 7)	7942	3	M
Environmental Science 1 – The Human Environment: Physical Processes http://wellness.lattc.edu/online/envsci1.html (Mar. 1 to Jun. 7)	7828	3	M
Geography 2 – Cultural Elements of Geography http://wellness.lattc.edu/online/geography2.html (Feb. 8 to Jun. 7)	7850	3	M
Health 8 – Women’s Personal Health http://wellness.lattc.edu/online/health8.html (Feb. 8 to Jun. 7)	7900	3	M
Health 11 – Principles of Healthful Living http://wellness.lattc.edu/online/health11.html (Feb. 8 to Jun. 7)	7893	3	M
History 11 – Political and Social History of the U.S. I http://wellness.lattc.edu/restrada/history11.html (Feb. 8 to Jun. 7)	7987	3	M
History 12 – Political and Social History of the U.S. II http://wellness.lattc.edu/restrada/history12.html (Feb. 8 to Jun. 7)	7980	3	M
Humanities 001 – Cultural Patterns of Western Civilization http://wellness.lattc.edu/gonzalez/humanities1.html (Feb. 8 to Jun. 7)	7941	3	O
Labor Studies 1 – American Labor History http://wellness.lattc.edu/online/laborstudies1.html (Feb. 8 to Jun. 7)	7861	3	M
Library Science 101 – Library Research Methods http://wellness.lattc.edu/online/library101.html (Mar. 1 to Apr. 3) http://wellness.lattc.edu/online/library101.html (Apr. 12 to May 14)	7829 7830	3	M
Marketing 1 – Principles of Selling http://wellness.lattc.edu/bessler/marketing1.html (Feb. 16 to Jun. 6)	7957	3	M

LATTC ON-LINE CLASSES

Marketing 11 – Fundamentals of Advertising http://wellness.lattc.edu/bessler/marketing11.html (Feb. 8 to Jun. 7)	7958	3	M
Math 105 – Arithmetic http://wellness.lattc.edu/tmeftagh/math105.html (Feb. 8 to Jun. 7)	7916	3	O
Math 112 – Pre-Algebra http://wellness.lattc.edu/tmeftagh/math112.html (Feb. 8 to Jun. 7)	7917	3	O
Math 115 – Elementary Algebra http://wellness.lattc.edu/tmeftagh/math115.html (Feb. 8 to Jun. 7)	7920	5	O
Math 125 – Intermediate Algebra http://wellness.lattc.edu/tmeftagh/math125.html (Feb. 8 to Jun. 7)	7921	5	O
Math 227 – Statistics http://wellness.lattc.edu/bakman/math227.html (Feb. 8 to Jun. 7)	7922	4	O
PhysEd 628 – Swim and Run Fitness http://wellness.lattc.edu/online/pe628.html (Feb. 8 to Jun. 7)	7912	1	M
PhysEd 750 – Sports Ethics http://wellness.lattc.edu/online/pe750.html (Feb. 8 to Jun. 7)	7915	1	M
PhysEd 762 – Ancient Olympic Games http://wellness.lattc.edu/online/pe762.html (Feb. 8 to Jun. 7)	7907	1	M
Political Science 1 – The Government of the United States http://wellness.lattc.edu/online/polisci1.html (Feb. 8 to Jun. 7)	7972	3	M
Psychology 1- General Psychology http://wellness.lattc.edu/koritzke/psych1.html (Feb. 8 to Jun. 7)	7975	3	M
Psychology 32- Psychology of Women http://wellness.lattc.edu/koritzke/psych32.html (Feb. 8 to Jun. 7)	7976	3	M
Psychology 41- Lifespan Psychology: Infancy to Old Age http://wellness.lattc.edu/koritzke/psych41.html (Feb. 8 to Jun. 7)	7981	3	M
Public Relations 1 – Principles of Public Relations http://wellness.lattc.edu/bessler/pubrelations1.html (Feb. 8 to Jun. 7)	7956	3	M
Refrigeration / Air Conditioning 208 – Refrigerant Management – EPA 608 Certification http://wellness.lattc.edu/construction/refac208.html (Feb. 8 to Jun. 7)	7866	4	M
Sociology 1 – Introduction to Sociology http://wellness.lattc.edu/jgarcia/sociology1.html (Mar. 16 to Jun. 7)	7983	3	M
Supervision 1 – Elements of Supervision http://wellness.lattc.edu/bessler/supervision1.html (Feb. 8 to Jun. 7)	7831	3	M
Supervision 11 – Oral Communications http://wellness.lattc.edu/bessler/supervision11.html (Feb. 8 to Jun. 7)	7845	3	M
Class Management Software (CMS) Codes: M = Moodle; O= Other web-based software. Symbols indicate: [PR] = pre-requisite required; [AT] = assessment test required			

Work Experience There Is No Substitute



Internships Through Cooperative Work Experience Education



This program allows students to earn college units for their on-the-job learning experiences. Students employed for 200 hours or more per week on a job related to their major are eligible to earn 4 units. Students who are employed in a job not related to their major may earn 3 units of credit. Through cooperation with their employer and the student, the cooperative education coordinator will aid the students in writing learning objectives to be completed on the job. Assistance will be given in preparing a learning agreement during the classroom sessions listed below. Students must be enrolled in a minimum of seven (7) units including Co-op Ed units.

Students employed in a job not related to their major should enroll in:

COOP ED General Course: 395
Section: 9001
Units: 3
Room: D-236

Students employed in a job related to their major should enroll in:

COOP ED MAJOR Course: 941
Section: See schedule
Units: 4
Room: D-236

Enrollment

The appropriate section number is listed in the schedule for most disciplines. You may enroll in the course by adding it to your directory card as you enroll for your regular classes. If the section number for your discipline is not listed, please attend the first class sessions listed below after the semester begins to add the course. You may phone (213) 763-3642 for assistance or e-mail interns@lattc.edu.

Attendance

You will meet with the instructor one hour weekly during the first six weeks of the semester at the flexible sessions listed below. Your attendance is essential to the program as the instructor will only be available at this classroom for the first six weeks. During this period the instructor will aid you in preparing documents necessary to qualify you for the program. All meetings are over by the end of the sixth week. For additional information you may call (213) 763-3642 preferably after 1:00p.m. The sessions listed below will begin the first week of the semester. The last day to add the course will be February 19, 2010. The meetings will be completed by March 18, 2010. Sessions are scheduled for 50 minutes.

DAY	CLASS MEETING	ROOM
Monday	5:00 p.m. only	D-236
Wednesday	12:00 & 5:00 p.m.	D-236
Thursday	5:00 p.m. only	D-236
All sessions are 50 minutes- select any one weekly		

APPRENTICESHIP EDUCATION



Apprenticeship Education

Enrollment in apprentice classes is limited to registered apprentices who are employed in the trade and are registered by the state. Apprenticeship students are all employed before attending classes.

The college offers related and supplemental training to apprentices who are formally registered and are employed in the industry. Under the jurisdiction of a Joint Apprentice

Committee only apprentices who have been registered by the state will be permitted to attend apprentice classes. For information concerning opportunities, please contact Mr. William (Bill) Elarton, Apprenticeship Director, in room B-122, phone (213) 763-3701 or Mr. Tom Vessella, Apprenticeship Coordinator, in room B-134A, phone (213) 763-3707.

This educational service to labor, management and government is established by the Shelley Maloney Act of 1939. Any person who is not registered and seeking information about becoming an apprentice should contact the Apprentice Information Center located at 320 West 4th Street, Suite #830, Los Angeles, CA 90013-1105. for information about the trade of interest. The phone number of the Department of Apprentice Standards is (213) 576-7750.

The apprenticeship students are all employed before attending classes. The Joint Apprenticeship Committee for each craft is listed below:

CABINET MILLWORK APPRENTICESHIP

*Apply at 10015 Rose Hills Road in Whittier.
Phone (562) 699-0419 for information.*

ELECTRICAL LINEMAN & ELECTRICAL CABLE SPLICER

Apply at various public utilities. Only public utilities employ line apprentices.

ENGINEER-OPERATION/ MAINTENANCE

*Apply at 2501 W. Third Street, Los Angeles,
(213) 385-2889.*

STATION ELECTRICIAN

Apply at Glendale Water and Power.





The Weekend College

A Program of Los Angeles Community College District

ITV/The Weekend College classes allow students to complete general education classes in a focused eight-week format.

Classes are taught on four campuses:

City [C] and **Southwest [SW]** Colleges on Saturdays, and **Valley [V]** and **Pierce [P]** Colleges on Sundays.

The first college listed is **AM only, 9:00-12:00 Noon**.

The second college listed is **PM only, 1:30-4:30 PM**.

Students may attend at any location or change locations, if necessary, throughout the semester.

The classes are taught by the same qualified LACCD instructor at each campus. Instructor is combined with award-winning video lessons available on DVD, in broadband, on cable television and in the College Learning Resource Centers. Each class also has an online component creating a positive, engaging learning environment.

Financial aid is available for qualified students; fee waivers apply to these classes. Transcripts are issued by L.A. Mission College.

WINTER 2010 January 4 – February 7, 2010

Classes	Section	Saturday Campus	Sunday Campus
Economics 1	7046	C/SW	P/V
English 101	7047	C/SW	P/V
English 102	7048	C/SW	P/V
Health 11	7049	C/SW	P/V
History 11	7050	C/SW	P/V
Philosophy 1	7051	SW/C	V/P
Political Science 1	7052	SW/C	V/P
Psychology 1	7053	SW/C	V/P
Psychology 41	7054	SW/C	V/P
Sociology 1	7055	SW/C	V/P

Saturday class meetings: January 9 - February 6, 2010

Sunday class meeting: January 10 - February 7, 2010

Last Day To:

ADD classes: January 10, 2010

Drop without incurring fees: January 7, 2010

SPRING 2010 Session A February 8 – March 28, 2010

Classes	Section	Saturday Campus	Sunday Campus
Economics 1	7056	C/SW	P/V
English 101	7057	C/SW	P/V
Health 11	7058	C/SW	P/V
History 11	7059	C/SW	P/V
Oceanography	7060	SW/C	V/P
Philosophy 1	7061	SW/C	V/P
Political Science 1	7062	SW/C	V/P
Psychology 1	7063	SW/C	V/P

No class meetings: February 13 & 14

Saturday class meetings: February 20 - March 27, 2010

Sunday class meetings: February 21 - March 28, 2010

Last Day To:

ADD classes: February 19, 2010

Drop without incurring fees: February 13, 2010

SPRING 2010 Session B April 6 – June 6, 2010

Classes	Section	Saturday Campus	Sunday Campus
English 101	7064	C/SW	P/V
English 102	7065	C/SW	P/V
Health 11	7066	C/SW	P/V
History 11	7067	C/SW	P/V
History 12	7068	C/SW	P/V
Math 125	7069	SW/C	V/P
Philosophy 1	7070	SW/C	V/P
Political Science 1	7071	SW/C	V/P
Psychology 41	7072	SW/C	V/P
Sociology 1	7073	SW/C	V/P

Saturday class meetings: April 10 - June 5, 2010

Sunday class meetings: April 11 - June 6, 2010

Last Day To:

ADD classes: April 18, 2010

Drop without incurring fees: April 12, 2010

Website: www.lamission.edu/itv • Telephone: 818/833-3594 or 800/917-9277

STUDENT RESOLUTION PROCESS



From time to time there may be a situation where you and your instructor do not agree. To assist both of you in coming to a positive conclusion, Trade-Tech has developed an informal complaint resolution process. This process is purely optional and is not intended to replace the grievance process, however, students are urged to avail themselves of it whenever feasible.

A form is available to assist you at every level. Should you not be able to resolve a matter at one level, you are asked to bring the form with you to the next level. There are three forms: pink (Level I), green (Level II) and goldenrod (Level III). Forms are available in individual department offices, in the Academic Affairs Dean's Office (A-119), and in the Compliance Office (LRC-257).

Following the informal students resolution process does not prevent you from filing an official Student Grievance through the LATTC Compliance Officer, Dr. Letia Royal-Burnett. For more information, consult the college catalog under "Student Grievance Procedure", or visit the college website at LATTC.edu and click on the "Compliance Office" link.

Level I (pink form)

The first step toward resolving a problem between a student and an instructor is for the two of you to meet. Most times talking it over will resolve the matter. However, if you are unable to resolve the problem between the two of you, please take a completed copy of this form to the Department Chair and discuss Step II proceedings

Level II (green form)

The second step toward resolving a problem between a student and an instructor is to schedule a meeting between the Department Chair, student and instructor. The Department Chair's role is to facilitate problem resolution by offering advice on College rules and regulations and clarifying individual responsibilities. To engage in Level II resolution, please take the pink Level I form, signed by both you and your instructor, to the Department Chair's office. A meeting will then be scheduled between you and your instructor.

Level III (goldenrod form)

The third step toward resolving a problem between a student and an instructor is to schedule a meeting with the Dean who supervises that department. To do this, you'll need to bring copies of both your Level I (pink) and Level II (green) student resolution forms with you.

COLLEGE & DISTRICT POLICIES

ACADEMIC FREEDOM

The Faculty shall have the academic freedom to seek the truth and guarantee freedom of learning to the students.

ACADEMIC STANDARDS

ACADEMIC/PROGRESS PROBATION

Students shall be placed on probation, if after attempting a minimum of 12 units, any of the following occur:

1. *Academic Probation: Low Grade Point Average. The student has a cumulative GPA of less than "C" (2.0).*
2. *Academic Probation: Transfer Student. The student has transferred with a cumulative GPA less than "C" (2.0).*
3. *Progress Probation. When the percentage of all units attempted in which grades of "W" (withdrawal), "Inc." (incomplete), and "NC" (no credit) reaches or exceeds 50%.*

ACADEMIC/PROGRESS DISMISSAL

A student on academic/ progress probation shall be DISMISSED from the College if:

1. *The cumulative GPA is less than 2.0 in all units attempted in each of three consecutive semesters. Or*
2. *If the percentage of "W", "Inc", and "NC" grades are 50% or greater in each of three consecutive semesters.*

Dismissal from one college in the Los Angeles Community College District shall disqualify a student from admission to any other college in the District.

APPEAL OF DISMISSAL

A student who is subject to dismissal may appeal to the College Dismissal Committee by submitting a Return From Disqualification Petition to the College Admissions Officer in R- 102. Petitions are accepted during specified time periods each semester.

ACCURACY STATEMENT

The Los Angeles Community College District and Los Angeles Trade-Technical College have made every effort to make this schedule accurate and may, without notice, change general information, courses, or programs offered. The reasons for change may include student enrollment, level of funding, or other issues decided by the district or college. The district and college also reserve the right to add, change, or cancel any rules, regulations, policies and procedures as provided by law.

ADMISSION AND RESIDENT CLASSIFICATION OF NON-CITIZENS

BOARD RULE 8100.10 *Admission and Residence Classification of Non-Citizens. It is the intention of the Los Angeles Community College District that no one be discriminated against in the admission and residence classification process on the basis of national origin. Further, it is the intention of the Board that subjective personal characteristics, such as appearance and speech, not be the basis for assumptions about national origin or immigration status. The Los Angeles Community College District shall admit all non-citizens who*

are able to benefit from instruction and who are not barred from enrollment under Federal and/or State law. Non-citizens shall be classified as resident or nonresident in accordance with applicable State and Federal laws, California Administrative Code Title 5, and District regulations. For all terms commencing on or after January 1, 2008, all nonresidents who enroll for six units or fewer shall be exempt from the nonresident tuition fee.

DIVERSITY

The policy of the Los Angeles Community College District is to implement affirmatively, equal opportunity to all qualified employees and applicants for employment without regard to race, color, national origin, ancestry, religion, creed, sex, age, handicap, marital status, medical condition (cancer related), sexual orientation, or veteran status. Positive action will be taken to ensure that this policy is followed in all personnel practices, including recruitment, hiring, placement, upgrading, transfer, demotion, treatment during employment, rate of pay or other forms of compensation, selection for training, layoff, or termination. A vigorous Affirmative Action Program will be maintained to ensure appropriate utilization of certain protected groups in specific areas and levels within the district workforce through the implementation of specific result-oriented procedures and activities (Board Rule 101301). Inquiries regarding Affirmative Action at Los Angeles Trade-Technical College should be directed to the College Diversity Representative, Dr. Letia Royal-Burnett, Compliance Office, (213) 763-7066.

ATTENDANCE

Only students who have been admitted to the college and are in approved active status may attend classes.

Students who pre-registered in a class and miss the first meeting may lose their right to a place in the class. Students should attend every meeting of all classes for which they register. To avoid being dropped from class, students should contact the instructor when they are absent for emergency reasons.

Students are responsible for dropping a class that they stop attending. If the class is not dropped, the student may receive an "F" in that class and be responsible for enrollment fee. Any drops or exclusions that occur between the end of the 4th week and the end of the 12th week will result in a "W" on the student's record which will be included in the determination of progress probation. Drops are not permitted beyond the end of the 12th week. An evaluative grade ("A", "B", "C", "D", "F", "CR", or "NC") will be assigned to students who are enrolled past the end of the 12th week even if they stop attending class, except in cases of extreme extenuating circumstances.

CONDUCT EXPECTED OF STUDENTS

Students enrolling in one of the Los Angeles Community Colleges may rightfully expect that the faculty and administrators will maintain an environment in which there is freedom to learn. This requires that there be appropriate conditions and opportunities in the classroom and on the campus. As members of the college community, students should be encouraged to develop the capacity for critical judgment; to engage in sustained and independent search for truth; and to exercise their rights to free inquiry and free speech in a responsible, nonviolent manner. Students shall respect and obey civil and criminal law, and shall be subject to legal penalties for violation of laws of the City, County, State, and Nation.

CLASSROOM CONDUCT

Instructors are responsible for presenting appropriate material in courses, and students are responsible for learning this material. Although it is a student's academic performance that is evaluated in determining grades, student conduct is important in the academic setting. Enrollment in a class may be terminated due to unsatisfactory student conduct, undue disrespect toward an instructor or administrator, or academic dishonesty. Each student is responsible for maintaining standards of academic performance established for each course in which he or she is enrolled.

BE ON TIME

Students are expected to attend and arrive on time for each class meeting. Class time is limited; students learn more and understand important concepts better if they always come on time for each class session.

RESPONSIBILITY TO BE INFORMED

It is the student's responsibility to read the information presented in this schedule and to know and observe all policies and procedures related to his/her program. Regulations will not be waived nor exceptions granted because a student pleads ignorance of policies, procedures, or deadlines.

PASS/NO PASS

Students may complete a request form to take a class on a Pass/No Pass basis through the sixth week of the semester. For Summer and Winter Semesters, through the second week. Courses, which students may elect to take on a Pass/No Pass basis, are listed in the college catalog. Request forms may be obtained at the Admissions Office, R-102.

The grade of P (pass) will be given if the performance in class is equal to a "C" grade or better.

The grade of NP (no pass) will be given if the performance in class is equal to a "D" or "FAIL" grade.

A student who has received credit for a course taken on Pass/No Pass basis may not convert this credit to a letter grade.

DRUG-FREE WORKPLACE POLICY

Los Angeles Trade-Technical College adheres to, supports, and is in full compliance with requirements that maintain our college as a drug-free institution of higher education.

The LACCD Board of Trustees has adopted the following standards of conduct:

- Students and employees are prohibited from unlawfully possessing, using or distributing illicit drugs and alcohol on district premises, in District vehicles, or as part of any activity of the Los Angeles Community College District.

The LACCD Board of Trustees has adopted Rule 9803.19, which prohibits:

- Any possession of controlled substances which would constitute a violation of Health and Safety Code section 11350 or Business and Professions Code section 4230, any use of controlled substances, the possession of which is prohibited by the same or any possession or use of alcoholic beverages while on any property owned or used by the District or colleges of the District. "Controlled substances," as used in this section, include, but are not limited to the following drugs and narcotics: opiates, opium and opium derivatives, mescaline, hallucinogenic substances, peyote, marijuana, stimulants, depressants, cocaine.

E-MAIL ACCOUNT FOR ENROLLED STUDENTS

Student e-mail accounts are created approximately 2 weeks after a student is enrolled in a class. To learn about your e-mail account, find the link on the campus home page to MyLATTTC Portal and click on it. That will redirect you to the web page with the directions and a tutorial video. Your login id is your student ID number and your password is the six numbers that represent mmddyy of your date of birth. You can create a nickname that will provide an alias for receiving email. However, you always log in using your student ID number.

EDUCATIONAL ENVIRONMENT POLICY

Due to requirement set forth by the Occupational Safety and Health Administration, proper attire, including shoes, eye ware, and other articles, should be worn during all class hours.

EMERGENCY INFORMATION

The College is concerned about your safety in case of an emergency. Detailed instructions are posted in every classroom and throughout the campus. Take a few minutes to read them and plan for your safety.

FAMILY EDUCATION RIGHTS AND PRIVACY ACT

See Student Records and Directory Information.

FEE EXEMPTION FOR SPECIAL PART-TIME & FULL-TIME STUDENTS GRADES K-12

Commencing with the Spring 2002 semester, non-resident students who are admitted as "Special Part-Time & Full-Time Students Grades K-12 under the Board Rule 8100.05 are also exempted from paying non-resident tuition for all semesters and terms including Summer and Winter Intersession. Please see Admissions & Records Office, R-102, for details.

FREEDOM OF SPEECH AREA AND PROCEDURES

Board Rule 9902, Article IX, states, "The college president shall designate an area or areas on the college campus as areas for free discussion and expression by all persons. A Free Speech Area may only be located where there is a normal flow of student traffic with unlimited accessibility. Necessary campus rules governing the operation of such areas shall govern only the time, place and manner in which said areas are to be used. All such rules shall be applied equally and fairly to all persons desiring to use the Free Speech Areas. No restrictions shall be placed on subject matter, topics or viewpoints expressed in Free Speech Areas.

In compliance with the above Board Rule, the college president has designated the K-Mall Quad as the Free Speech Area. All individuals or organizations wanting to use the Free Speech Area, must check into the Vice President of Student Services office, located in A-129, prior to use of this area. The guidelines and rules for use of this area, along with time, place and manner will be distributed to the interested party. This procedure does not apply to activities sponsored by the college.

GRADES AND GRADE CHANGES

The instructor of the course shall determine the grade to be awarded to each student in accordance with the college's Grading Symbols and Definitions Policy. The determination of the student's grade by the instructor is final in the absence of mistake, fraud, bad faith or incompetence. The removal or change of an incorrect grade from a student's record shall only be done upon authorization by the instructor of the course.

Students may file a petition for grade change in the Admissions and Records office. Grade change Petitions must be submitted within a year after the grade was assigned. In the case of fraud, bad faith or incompetence, the final determination concerning removal or change of grade will be made by the College President.

GRADE REQUEST AND NOTIFICATION

Students can access their grade information through the Student Telephone Enrollment Process (STEP) by following the steps below:

1. Dial one of the following numbers: (213) 689-8888; (310) 605- 0505; (818) 988-2222; (323) 226-1999. STEP's voice response will guide you with each entry. Press * to correct any mistakes.
2. Press 7 for Los Angeles Trade-Technical College
3. Press 0 for Winter, 1 for Spring, 2 for Summer, or 3 for the Fall semester
4. Enter your Student ID Number
5. Enter your Personal Identification Number (PIN) (four digits number of your birthday)
6. Press 3 to hear your grades
7. Press 3 to exit the system

If you need a copy of your grades, you can obtain a grade printout from the web. This printout is NOT a Transcript or a Verification of Enrollment. If you need an Official Transcript or a Verification of Enrollment, you may order them from the Admission Office.

INCOMPLETE

A grade of "Inc" (incomplete) may be made up no later than ONE YEAR following the end of the term in which it was assigned by making personal arrangements with the instructor. If the Incomplete is not made up by the deadline, THE INCOMPLETE WILL BE REMOVED AND REPLACED BY A GRADE DETERMINED BY THE INSTRUCTOR. A CLASS MAY NOT BE REPEATED TO CLEAR AN INCOMPLETE GRADE.

GRADUATION

Please refer to the current College catalog for specific graduation requirements.

GRADUATION APPLICATION FOR DEGREES/ CERTIFICATES

All students must file an application for degree/certificate evaluation during the first 6 weeks of the semester in which they expect to complete their degree/ certificate requirements. Students completing the course work during the Summer Session must file an application during the first 6 weeks of the preceding Spring Semester. Late applications are not accepted. Applications are available in the Admissions and Records Office, R-Building, R-102, Graduation Windows 8 and 9.

The following requirements apply to students entering for the first time after July 2, 1983. Continuing students with uninterrupted attendance and demonstrating satisfactory progress, exclusive of summer session, should refer to the College Catalog in effect at the time of their initial enrollment. A continuing student is one who has completed a minimum of one course per semester, except that completion with a "W" will be accepted for one semester only.

Prior to the end of the semester in which the application is filed, students will be notified by mail of their degree/certificate evaluation.

Students who do not complete requirements must submit a new application during the first 6 weeks of the semester in which they expect to meet requirements. Students successfully completing all requirements will be NOTIFIED THROUGH U.S. MAIL when their degree/certificate is ready for pick-up, based on the following schedule:

- Students completing all requirements by the end of the Fall Semester will have the degree/certificate ready after June 15.
- Students completing all requirements by the end of the Spring Semester will have degree/certificate ready after August 15.
- Students completing all requirements by the end of Summer Session will have degree/certificate ready after September 15.

Students Must Present The Notification Card And Proper Photo Identification When Picking-up Degree/ Certificate. Diplomas and/or Certificates will be held for only one year after the Diploma/Certificate graduation date. Qualified graduates who do not pick-up their Diploma/Certificate within the above time frame must submit a request for a duplicate Diploma/ Certificate and will be assessed a fee for duplicate preparation.

HOPE SCHOLARSHIP TAX CREDIT

According to federal tax credit legislation, students who are enrolled at least half-time (6 or more units) on census day and who have paid enrollment fees may be able to deduct their enrollment fees on their federal income tax. For more information and the necessary forms, go to the Admissions Office (R-102), the Business Office (K-126) or Financial Aid Office (TN) and ask for IRS form W-9.

LIMITED ENGLISH PROFICIENCY

Occupational education classes are open to all students. The lack of proficiency in English is no barrier to enrollment in occupational educational courses, although the college suggests that students who are deficient in English use the services of the college that we provide for persons who are limited in English proficient or speak English as a second language.

ESTUDIANTES CON FALTA DE COMPETENCIA EN LENGUA INGLESA

Los cursos relacionados con la educación para carreras intermedias u ocupacionales gozan de disponibilidad para todos los estudiantes. La falta de competencia en lengua inglesa no constituye barrera alguna para poder inscribirse en dichos cursos. Por otro lado, el plantel les sugiere a aquéllos que aún no dominan el inglés que hagan uso de los servicios que la institución les ofrece a tales personas.

英语能力有限的学生

学校的职业訓練課程是開放給所有學生。英语能力有限的學生註冊職業課是不受任何限制。本校建議學生使用我們所提供的雙語服務。

NONDISCRIMINATION POLICY

All programs and activities of the Los Angeles Community College District shall be operated in a manner which is free of discrimination on the basis of race, color, gender, national origin, ancestry, religion, creed, pregnancy, marital status, medical condition (cancer related), gender orientation, age, disability, or veteran status (Reference: Board Rule 1202). Inquiries regarding Affirmative Action issues should be directed to Dr. Letia Royal-Burnett, (213) 763-7066. Inquiries relating to disabilities and special accommodations per the Americans with Disabilities Act should be directed to Ms. Donna Lichtman, Director of Disabled Students Programs and Services, (213) 763-3773 & TDD (Telecommunications Device for the Deaf) (213) 763-5375.

NORMAS DEL PLANTEL REFERENTES A LA DISCRIMINACIÓN

Todos los programas y actividades de Los Angeles Community College District se llevan a cabo libres de cualquier tipo de discriminación racial o de discriminación referente al color, género, nacionalidad, ascendencia, religión, credo, preñez, estado matrimonial, condición médica (con relación al cáncer), orientación sexual, edad, discapacidad, veteranía de las fuerzas armadas (Referencia: Board Rule 1202). Toda averiguación concerniente a Affirmative Action (Acción afirmativa) deberá dirigirse a Dr. Letia Royal-Burnett, (213) 763-7066. Averiguaciones concernientes a la discapacidad y acomodo especial referente a las normas de Americans with Disabilities Act (Ley de discapacidad de los Americanos) deberán dirigirse a Donna Lichtman, Directora del programa y servicios para estudiantes discapacitados, (213) 763-3773. Personas sordomudas, por favor, dirigirse al teléfono (213) 763-5375.

免于歧视政策

洛杉矶公立大学学区政策的所有课程和活动是免于歧视种族, 肤色, 性别, 国籍, 血缘, 宗教, 信仰, 怀孕, 婚姻, 健康癌症), 性向, 年龄, 伤残, 或 退伍军人状态 (委员会规则 120 询问有关平权法 (Affirmative Action) 請聯絡 Dr. Letia Roy Burnett, (213) 763-7066. 问有关伤残和特别膳宿供应与美国残法案, 請聯絡 Donna Lichtman 女士, 残疾学生服务主任 (213) 763-3773 & TDD (聋人电信设备)(213) 763-5375.

OPEN ENROLLMENT

Unless specifically exempted by law, every course for which State Aid is claimed is fully open to any person who has been admitted to the college and who meets the appropriate recommended academic prerequisites.

PARKING ON CAMPUS

The parking information contained in the Schedule of Classes is intended to provide individuals with basic guidelines on the College's parking program, rules, regulations, and enforcement policies. For the complete text of this information, please refer to the current College catalog. This information may also be obtained from the College Sheriff's Department, D-150, the Administrative Projects Office, A-108, or the College website (www.lattc.ca.us/html/Parking-Info.htm).

PARKING GUIDELINES

All parking is by valid College permit only. Parking permits are made of removable mylar and should be affixed to the inside of the rear window (right side). Parking permits must be displayed at all times a vehicle is parked on campus, weekends included. The purchase of a parking permit does not guarantee a specific parking space; it is only a license to park one vehicle in designated parking lots as posted at the entrance of each parking lot.

Student parking permits are available for purchase at the Business Office for \$20 per permit per semester for Spring and Fall.

A valid college parking permit and a DMV placard must be displayed on any vehicle parked in a designated handicapped stall. Students with a verified disability should go to the Disabled Students Program and Services Office, E-110, to arrange for an accommodation.

STUDENT PARKING PERMIT SALES, REFUNDS AND EXCHANGES

Inquiries regarding the College's parking should be directed to the following offices during normal business hours: Parking Rules, Regulations, Permit Use, and Enforcement: College Sheriff's Department, D-150, (213) 763-3600 Permit Sales, Refunds, and Exchanges: Business Office, K-126, (213) 763-7225. College Sheriff's Department personnel are on duty 24 hours a day, seven days a week to assist with permit use and enforcement issues.

TRANSPORTATION

The college is located near the intersection of the Harbor and Santa Monica freeways, and is directly across the street from the Metro Blue Line's Grand Avenue station. In addition to the light rail system, there are more than 40 bus lines stopping at or within two blocks of the College. For more information, please consult the College website at www.LATTC.edu.

SEXUAL ASSAULT

The policy of the Los Angeles Community College District is committed to providing a safe environment for its students, faculty, and staff. The Los Angeles Community College District Board of Trustees condemns any act of sexual assault committed on any of its facilities. In the event of sexual assault committed on grounds or in facilities maintained and/or used by the District, any victim of a sexual assault who is one of the District's students, faculty, staff, or visitors shall promptly receive appropriate treatment and full and accurate information. Individuals who commit sexual assault while on properties within the control of the District shall be subject to appropriate criminal prosecution and/or District disciplinary procedures.

Confidentiality is fundamental to all aspects of cases dealing with sexual assault. The names of sexual assault victims shall not be revealed by persons responsible for implementing and enforcing the provision of this Chapter, except with the consent of the victim. College Sheriff's Department, (213) 763-3611.

Please contact Letia Royal-Burnett on 213-763-7066 for information about making a complaint of unlawful discrimination or harassment

SMOKING/NON-SMOKING POLICY

Smoking is not permitted in any classroom or other enclosed facility or adjacent entrances and exits, porches, decks and stairwells. Smoking is permitted only in designated areas

SOCIAL SECURITY NUMBERS/STUDENT IDENTIFICATION NUMBER

Effective July 24, 2006, Los Angeles Community College District will no longer use the social security number as a student identifier. State Law requires the college district to issue a separate student identification number to identify students which will help protect the confidentiality of students' social security numbers. However, for financial aid purposes, social security numbers will be required.

STANDARDS OF STUDENT CONDUCT

A student enrolling in one of the Los Angeles Community Colleges may rightfully expect an environment in which there is freedom to learn. This in turn requires that there be appropriate conditions in the classroom and on the campus. To this end, all persons shall respect and obey civil and criminal law, and shall be subject to legal penalties for violation of laws of the city, county, state and nation. All visitors making use of the facilities or grounds of any college of the District will be expected to abide by the Standards of Conduct and the rules relating to campus visitors adopted by the Board of Trustees. Violations of all such rules and regulations, may result in disciplinary action depending on the individual's status as student, faculty, staff or visitor. Violations of rules and regulations include but are not limited to the following:

BOARD RULE 9803.10: *Willful Disobedience.* Willful disobedience to directions of College officials acting in the performance of their duties.

BOARD RULE 9803.11: *Violation of College Rules and Regulations.* Violation of College rules and regulations, including those concerning student organizations, the use of College facilities, or the time, place, and manner of public expression or distribution of materials.

BOARD RULE 9803.12: *Dishonesty.* Dishonesty, such as cheating, or knowingly furnishing false information to the colleges.

Board Rule 9803.13: *Unauthorized Entry.* Unauthorized entry to or use of the college facilities.

BOARD RULE 9803.14: *College Documents.* Forgery, alteration, or misuse of college documents, records, or identification.

BOARD RULE 9803.15: *Disruption of Classes.* Obstruction or disruption of classes, administration, disciplinary procedures, or authorized college activities.

BOARD RULE 9803.16: *Theft of or Damage to Property.* Theft of or damage to property belonging to the college, a member of the college community, or a campus visitor.

BOARD RULE 9803.17: *Interference With Peace of College.* The malicious or willful disturbance of the peace or quiet of any of the Los Angeles Community Colleges by loud or unusual noise, or any threat, challenge to fight, fight, or violation of any rules of conduct as set forth in this Article. Any person whose conduct violates this section shall be considered to have interfered with the peaceful conduct of the activities of the college where such acts are committed.

BOARD RULE 9803.18: *Assault or Battery.* Assault or battery, abuse or any threat of force or violence directed toward any member of the college community or campus visitor engaged in authorized activities.

BOARD RULE 9803.19: *Alcohol and Drugs.* Any possession of controlled substance which would constitute a violation of Health and Safety Code section 11350 or Business and Professions Code section 4230, any use of controlled substances the possession of which are prohibited by the same, or any possession or use of alcoholic beverages while on any property owned or used by the District or colleges of the District. "Controlled substances," as used in this section, include but are not limited to the following drugs and narcotics:

- a. opiates, opium and opium derivatives
- b. mescaline
- c. hallucinogenic substances
- d. peyote
- e. marijuana
- f. stimulants and depressants
- g. cocaine

BOARD RULE 9803.20: *Lethal Weapons.* Possession, while on a college campus or at a college-sponsored function, of any object that might be used as a lethal weapon is forbidden all persons except sworn peace officers, police officers, Sheriff, and other governmental employees charged with policing responsibilities.

BOARD RULE 9803.21: *Discriminatory Behavior.* Behavior while on a college campus or at a college-sponsored function, inconsistent with the District's non-discrimination policy, which requires that all programs and activities of the Los Angeles Community College District be operated in a manner which is free of discrimination on the basis of race, color, national origin, ancestry, religion, creed, sex, pregnancy, marital status, sexual orientation, age, handicap or veterans status.

BOARD RULE 9803.22: *Unlawful Assembly.* Any assemblage of two or more persons to 1) do an unlawful act, or 2) do a lawful act in a violent, boisterous or tumultuous manner.

BOARD RULE 9803.23: *Conspiring to Perform Illegal Acts.* Any agreement between two or more persons to perform illegal acts.

BOARD RULE 9804: *Interference with classes.* Every person who, by physical force, willfully obstructs, or attempts to obstruct, any student or teacher seeking to attend or instruct classes at any of the campuses or facilities owned, controlled or administered by the Board of Trustees of the Los Angeles Community College District, is punishable by a fine not exceeding five hundred dollars (\$500) or imprisonment in a county jail not exceeding one year, or both such fine and imprisonment. As used in this section, "physical force" includes, but is not limited to, use of one's person, individually or in concert with other, to impede access to or movement within or otherwise to obstruct the students or teachers of the classes to which the premises are devoted.

BOARD RULE 9805: *Interference with performance of duties of employees.* Every person who attempts to cause, or causes, any officer or employee of any of the Los Angeles Community Colleges or any public officer or employee to do or refrain from doing, any act in the performance of his/her duties, by means of a threat to inflict any injury upon any person or property, is guilty of a public offense.

BOARD RULE 9805.10: *Assault or abuse of Instructor.* Every parent, guardian, or other person who assaults or abuses any instructor employed by the District in the presence or hearing of a community college student or in the presence of other community college personnel or students and at a place which is on District premises or public sidewalks, streets, or other public ways adjacent to school premises, or at some other place where the instructor is required to be in connection with assigned college activities is guilty of a misdemeanor.

BOARD RULE 9806: *Unsafe Conduct.* Conduct which poses a threat of harm to the individual and/or to others. This includes, but is not limited to, the following types of conduct: Unsafe conduct in connection with a Health Services Program (e.g., Nursing, Dental Hygiene, etc.); failure to follow safety direction of District and/or college staff; willful disregard to safety rules as adopted by the District and/or college; negligent behavior which creates an unsafe environment.

DISCIPLINARY ACTION

Community college districts are required by law to adopt standards of student conduct along with applicable penalties for violation. The Los Angeles Community College District has complied with this requirement by adopting Board Rule 9803, Standards of Student Conduct (See above). Board Rule 9804, Student Discipline Procedures, provides uniform procedures to assure due process when a student is charged with a violation of the Standards of Student Conduct. Disciplinary measures may be taken by the College independently of any charges filed through civil or criminal authorities, or both. Copies of the Student Discipline Procedures are available in the Vice President of Student Services Office, TF, (213) 763-7078.

STUDENT GRIEVANCE PROCEDURES

The purpose of the Student Grievance Procedures is to provide a prompt and equitable means for resolving student grievances. The procedures enumerated in Administrative Regulation E-55 shall be available to any student or applicant for admission, who believes a College decision or action has adversely affected his or her status, rights, and/or privileges as a student. The procedures shall include, but not be limited to, alleged violations of Title IX of the Higher Education Amendments of 1972 (and applicable regulations), grievances relating to disabled students as defined by Section 504 of the Rehabilitation Act of 1973, and grievances relating to course grades to the extent permitted by Education Code Section 76224(a). Section 76224(a) provides:

"When grades are given for any course of instruction taught in a community college district, the grade given to each student shall be the grade determined by the instructor of the course and the determination of the student's grade by the instructor, in the absence of mistake, fraud, bad faith, or incompetence, shall be final." For additional information, contact the college Ombudsperson at (213) 763-7066.

OMBUDSPERSON

Pursuant to the Student Grievance Procedure, the College Ombudsperson has been appointed by the President to assist the student in obtaining informal resolution of his or her grievance. If an informal resolution is not obtained, then the Ombudsperson will arrange for the formation of a Grievance Hearing Committee to hear the student's grievance and will facilitate the hearing process pursuant to District Administrative Regulation E-55. The Compliance Officer may be contacted at (213) 763-7066.

STUDENT RECORDS AND DIRECTORY INFORMATION

The Los Angeles Community College District, in compliance with Federal and State law, has established policies and procedures governing student records and the control of personally identifiable information. The Los Angeles Community College District recognizes that student records are a confidential matter between the individual student and the College. At the same time the District has a responsibility to fulfill public information needs (i.e., information about students participating in athletics, announcement of scholarships and awards, etc.). To meet this responsibility the District may release Directory Information unless the student states in writing that he or she does not want it released. The responsibility for carrying out these provisions is charged to the College Records Officer, designated by the chief administrative officer on each campus. The Records Officer may be contacted via the Office of Admissions. Copies of Federal and State laws and District policies and procedures are maintained by the Records Officer and are available for inspection and inquiry. No information may be given via telephone request.

All student records maintained by the various offices and departments of the College, other than those specifically exempted by law, are open to inspection by the student concerned. The accuracy and appropriateness of the records may be challenged in writing to the Records Officer. A student has the right to receive a copy of his or her record, at a cost not to exceed the cost of reproduction. (Requests for transcripts should be made directly to the Office of Admissions).

No student records, including Directory Information, will be released without the written consent of the student concerned except as authorized by law. A log of persons and organizations requesting or receiving student record information is maintained by the Records Officer. The log is open to inspection only to the student and the community college official or his or her designee responsible for the maintenance of student records.

Directory Information includes the student's name, city of residence, participation in officially recognized activities and sports, weight and height of members of athletic teams, dates of attendance, degrees and awards received, and the most recent previous educational agency or institution attended by the student. This information will not be released to anyone if the student marks "NO" on question #28 on the College Application or if the student marks "NO" on the College's Release of Directory Information form. This form is available in the Admission Office.

In addition, under federal law, the military is entitled to receive the following student information for recruitment purposes: student directory information as defined above, student address, telephone number, date and place of birth, and major field of study. This information will not be released to the military if the student marks "NO" on question #28 on the College Application or if the student marks "NO" on the College's Release of Directory Information form.

All inquiries regarding student records, Directory Information, and policies for records access, release, and challenge should be directed to the Records Officer via the Office of Admissions. Students have the right to file a complaint with the United States Department of Education concerning alleged violations of Federal and State laws governing student records.

STUDENT RIGHTS AND RESPONSIBILITIES

All students are urged to carefully read the General Information section of the College Catalog. It is the utmost importance that you understand the Standards of Student Conduct as outlined in the Catalog.

STUDENT RIGHT TO KNOW

GRADUATION RATES

In compliance with the Student-Right-to-Know and Campus Security Act of 1990, the graduation rate of full-time, certificate or degree seeking students who entered in the Fall 1999 semester and graduated no later than academic year 2001-2002 is 21.6%; the Transfer rate is 35.1%

More information about Student Right-to-Know Rates can be found at the California Community Colleges "Students Right-to-Know Rates Information Clearinghouse Website" located at <http://srtk.cccco.edu>.

CRIME REPORTING PROCEDURES

*Safety at Los Angeles Trade-Technical College is everybody's concern. The Los Angeles Community College District maintains a Sheriff's Department in operation 24 hours a day. Any criminal activity can be reported at any time of day or night by calling extension (213) 763-3611 from any college phone or *80 from any pay phone. The college Sheriff's Department office is located in D-150, on the northwest corner of 21st Street and Grand Avenue.*

CAMPUS SECURITY ACT-THE CLEARY ACT (ANNUAL REPORTS)

Los Angeles Trade-Technical College, in compliance with the Federal Student Right to Know and Campus Security Act of 1990, provides the campus crime statistics for three calendar years. Below are the campus crime statistics for 2006, 2007, and 2008 calendar years.

The College Security Report is also posted at the College Sheriff's office website which can be accessed through the web address: http://www.lattc.edu/lattc/sheriff/sheriff_crime_status.htm. A paper copy of the report is also available upon request at the college Sheriff's office. D150.

OFFENSES REPORTED Year January 1 to December 31	OCCURRENCES		
	2008	2007	2006
Arrest	51	44	58
Assaults	3	15	5
Auto Burglaries	12	14	11
Burglaries	16	12	14
Graffiti/Vandalism	19	44	28
Grand Theft	36	25	15
Grand Theft Auto	2	5	15
Liquor Law Violations	2	3	0
Marijuana Possession Detentions	28	18	13
Murders	0	0	0
Manslaughter	0	0	0
Narcotics Violations	28	18	13
Petty Thefts	70	73	51
Rape	0	0	0
Rape Attempt	0	0	0
Robberies	2	7	3
Weapon Violations	1	1	2
Miscellaneous Reports	52	56	NR

TRANSCRIPTS

Transcripts are available to students upon written request. Transcript Request Forms are available in the Admissions Office (R-102). District policy prohibits the acceptance of Transcript Requests over the phone. Please consult the Admissions and Records Office for fees and time schedules for delivery.

VERIFICATIONS OF ENROLLMENT

Verification of the Student's Enrollment may be obtained upon written request. Verification Request Forms are available in the Admissions Office (R-102). District policy prohibits the acceptance of Verification Requests over the phone. Please allow ten (10) working days for processing. Requests for Verification of Enrollment by Agencies or Individuals other than the student must be accompanied by a signed release.

VIEWING YOUR RECORDS

Under the provisions of the Family Education Rights and Privacy Act of 1974 students may see their records by making an appointment with a counselor for this purpose.

CAMPUS OFFICES & SERVICES

ADMISSION AND RECORDS

(213) 763-5300

Location: R-102

The Admissions and Records Office is located in Building "R", Room 102. Office hours are Monday to Thursday 8:30 a.m. to 7:00 p.m. and Friday 8:30 a.m. to 3:00 p.m. Services include admission to the college, registration, maintenance and protection of students' records, receiving and processing grade rosters and other related documents, evaluation of certificates and graduation applications, processing transcripts and petitions, and verifying student enrollment. We also provide service to Veteran students.

BRIDGES TO SUCCESS CENTER

(213) 763-5560

(213) 763-5661 En Español

Location: C-108

E-mail: bridge@lattc.edu

The Bridges to Success Center is a gateway to college for those students that are still enrolled in K-12 grades, wish to take noncredit and continuing education, adult students who had not considered college before and immigrants/second language learners. We help students earn their high school diplomas and GEDs, start college early, enter short-term career training that prepares them for high demand careers, strengthen their basic academic skills and prepare them to successfully enter the workplace. We are a one-stop center that provides our students with high-touch services to make their transition to college a smooth one.

CAREER CENTER

(213) 763-7104

Location: C-107A

The Career Center's mission is to promote effective career counseling and planning. Experienced staff assist students with career options and provide career assessments, interpretations, guidance and assist students with developing career objectives and educational opportunities. Hours are: Monday – Tuesday, 10:00 a.m. – 3:30 p.m., Wednesday, 9:00 a.m. – 3:00 p.m., Thursday, 9:00 a.m. – 1:00 p.m.

CHILD DEVELOPMENT CENTER

(213) 763-3690

Location: Corner of Olive & 21st

The Campus Child Development Center provides free or low cost childcare to eligible parents who attend classes, job training, and/or are working. The Center serves children between the ages of 12 months and 5 years old. Hours are from 6:30 a.m. to 5:00 p.m., Monday through Thursday, 4:00 p.m. on Friday. Evening childcare is available for children between 5 and 12 years of age from 4:30 p.m. to 9:30 p.m., Monday through Thursday.

COOPERATIVE AGENCIES RESOURCES FOR EDUCATION (C.A.R.E.)

(213) 763-7117

Location: Temp. Building TQ

The CARE is a special program for a unique group of EOPS students. The CARE program provides additional services to students who are single parents, head-of-household, receive public assistance (AFDC) and have at least one child age 14 or younger. Hours are Monday-Thursday: 8:00 a.m. – 7:00 p.m., Fridays: 8:00 a.m. – 4:00 p.m.

COUNSELING SERVICES

(213) 763-7354

Location: H-130

Counselors are available to provide academic, vocational, personal, and support services to students. It is recommended that students who have attended other colleges bring copies of transcripts from those colleges for review. Counseling Center hours: 8:00 a.m. – 6:30 p.m., Monday through Thursday & 8:00 a.m. – 3:00 p.m., Friday. Appointments are available beginning the first week of each term.

DISABLED STUDENT PROGRAM & SERVICES (DSP&S)

(213) 763-3773

Location: E-110

The Disabled Student Services Program provides specialized counseling, priority registration, parking (with medical verification). With documentation, arrangements will be made for interpreters, test proctoring, note-taking, tutoring, and other services. Office hours are Monday through Thursday, 8:30 a.m. – 4:30 p.m., Friday, 8:30 a.m. – 1:30 p.m.

*** ATTENTION DISABLED PLACARD HOLDERS ONLY****

If the elevator for the F building is not functioning. You may call the Sheriff's Office for an escort. Please call 213-763-3600 or you may also use the emergency blue phone next to the elevator.

EXTENDED OPPORTUNITY PROGRAM AND SERVICES (EOPS)

(213) 763-7097/7117

Location: Temp. Building TR & TQ

Extended Opportunity Program and Services (EOPS) is designed to supplement existing college programs and to provide assistance to aid financially and educationally disadvantaged full-time students. EOPS services include counseling (academic, career, personal); priority registration; tutoring, personal development courses and assistance with books and supplies. Hours are Monday through Thursday, 8:00 a.m. to 4:00 p.m.; Friday: 8:00 a.m. to 4 p.m.

FINANCIAL AID SERVICES

(213) 763-7082

Location: Temp. Building TN-100

Los Angeles Trade-Technical College offers federal and state financial aid to applicants who demonstrate that they can meet only a fraction of the cost required to attend college. Trade-Tech offers the following programs:

- Federal Pell Grant and Federal Work Study (FWS)
- Board of Governors Fee Waivers
- Scholarships
- Federal Supplemental Educational Opportunity Grant (FSEOG)
- Federal Perkins Loans
- Federal Direct Loans
- Academic Competitiveness Grant (ACG)
- California State Grants (Cal Grants)

Students can apply for one or more of these programs by filing a Free Application for Federal Student Aid (FAFSA). For additional information, contact the Financial Aid office or stop by and pick up an "Information Guide", your guide to financial aid programs and services in the Los Angeles Community College District. For detailed explanations related to obtaining and using financial aid, please call for an appointment with a Financial Aid Technician. Office hours: 9:00 a.m. – 2:00 p.m., Monday-Friday and 4:30 p.m. – 7:30 p.m., Monday-Thursday.

IMPORTANT NOTICE: You may have to repay federal funds if you are paid for classes you did not attend or stopped attending. Contact the Financial Aid Office before withdrawing from your classes! (213) 763-7082, Temp. Building TN-100.

GAIN/CALWORKS

(213) 763-7109

Location: Temp. Building TE

GAIN/CalWORKs is a job training program that provides extensive services for the participants receiving Temporary Aid for Needed Families (TANF). Educational services; academic, career and personal counseling and case management; job development/placement, and assistance with the cost of books and supplies are some of the services provided. Office hours: Monday – Friday, 8:00 a.m. – 4:00 p.m., and posted evening hours.

INFORMATION CENTER

(213) 763-5337

Location: R-100

The Information Center provides general information about the campus, programs and services LATTC has to offer. Bilingual student employees are also available to assist the ESL population with their inquiries. Office hours: 8:30 a.m. – 7:00 p.m., Monday through Thursday, 8:30 a.m. – 3:00 p.m., Friday.

INTERNATIONAL STUDENTS

(213) 763-5345

Location: Building R-100

Los Angeles Trade-Technical College (LATTC) welcomes applications from international students. We also accept transfer applications for F-1 Visa students currently studying in the U.S. as well as Change of Status applications for visitors who currently have other visas. Applications may be obtained by contacting the office or on-line. Office Hours: Mon-Thurs. 9:00 am - 6:00 pm, Fri. 9:00 am - 3:00 pm. Office hours are subject to change. Please call for an appointment. Website: <http://www.lattc.edu/dept/TADR/IntStu/ishome.htm> • Email: intstud@lattc.edu

LIBRARY

Circulation: (213) 763-3950

Reference Desk: (213) 763-3958

Location: LRC

The Library is located on the first and second floors of the Learning Resources Center. Available materials include books, periodicals, microforms and CD-ROM applications. The book collection, periodicals and encyclopedias can be accessed through the online public access catalog. Library hours: Monday – Thursday, 8:00 a.m. – 6:50 p.m., Friday, 8:00 a.m. – 1:00 p.m., closed Saturdays, Sundays and school holidays.

MATRICULATION

(213) 763-5348

Location: K-008

Matriculation services at Trade-Tech are designed to maximize student's opportunities to succeed. Services include: Basic Skills assessments and Accuplacer exams; on-line and in-person orientation; and "Early Alert" services providing mid-semester evaluation of your academic progress. The Matriculation Office is located in the K-Building basement. Office hours: 8:30 a.m. – 5:00 p.m., Monday through Thursday, 8:30 a.m. – 1:00 p.m., Friday.

PUEENTE PROJECT

(213) 763-7157

Location: E-107

The Puente Project is an academic preparation program whose mission is to increase the number of educationally disadvantaged students to transfer to a college or a university, earn college degrees and return to the community as members and leaders for future generations. Puente uses a combination of teaching, counseling and mentoring to achieve its educational objectives. For more information about the program, contact Puente Office. Hours: Tuesday & Thursday, 8:30 a.m. – 4:00 p.m.

STUDENT ACTIVITIES OFFICE

(213) 763-7205

Location: C-105

This office coordinate extracurricular educational and social activities for students, including: clubs, ethnic/cultural programs, Deans and President's Awards ceremonies, social dances, blood drives, and the Associated Student Organization (ASO) Council. Office hours: 8:30 a.m. - 6:00 p.m., Monday to Thursday and 8:30 a.m. - 4:30 p.m. on Fridays.

STUDENT EMPLOYMENT CENTER

(213) 763-7124

Location: C-107A

This office assists students in finding full, part time or temporary jobs, and offers personal assistance with resumes and cover letters. It provides employment information to alumni related to their academic/ vocational program. Individual employment advisement is available by appointment. Office hours: 8:00 a.m. – 1:00 p.m. & 3:00 p.m. – 6:00 p.m., Monday – Thursday, 8:00 a.m. – 1:00 p.m., Friday.

STUDENT HEALTH CENTER

(213) 763-3764

Location: E-102

The Student Health Center offers non-emergency healthcare services to students, including preventative health education, physician services, and women's health. Hours are: Monday 10:00 a.m. - 6:00 p.m. Tuesday, Wednesday, Thursday 8:00 a.m. - 4:00 p.m., Friday 8:00 a.m. - 12:00 p.m.

UMOJA PROGRAM

(213) 763-7358

Location: R-100

Umoja is a Ki-Swahili (African) word for Unity. The Umoja Program is a community and critical resource dedicated to enhancing the cultural and educational experiences of African-American and other students. Umoja believe that when the voices and histories of students are deliberately and intentionally recognized, the opportunity for self-efficacy emerges and the foundation is formed for potential academic success. The following services are provided:

- Cultural events, field trips, and workshops
- Personal Development Classes (College Survival)
- Math & English Classes
- Umoja Counseling
- Mentoring & Life Coaching
- Career & Personal Development
- Financial Aid Services

UNIVERSITY TRANSFER CENTER

(213) 763-7154

Location: H-134

<http://college.lattc.edu/transfer/>

The University Transfer Center provides services to students interested in transferring to a four-year college or university, including workshops, appointments with visiting representative and trips to colleges and universities. Office hours: Monday- 9:00 a.m. to 6:00 p.m., Tuesday- 9:00 a.m. to 3:30 p.m., Wednesday- 9:00 a.m. to 3:00 p.m., Thursday 9:00 a.m. to 4:00 p.m., and Friday 9:00 a.m. to 1:00 p.m.

Associated Students Organization (ASO) is You!



Get involved with student activities at the best community college around.

Events. Clubs. Conferences. Discounts. Fundraisers. Fun.



Join the Associated Students Organization (ASO) family by coming by the ASO Office in the C-building or calling 213 763-7200.

ASO is the student government.

We advocate for student rights by addressing your issues and concerns.

We represent the 15,000-plus Trade Tech student body.



LOS ANGELES TRADE-TECH
LATTC
 A Community College

DIRECTORY

FROM OFF CAMPUS: DIAL (213) 763-XXXX (SEE LISTED PHONE NUMBER)

INFORMATION & SERVICES

Activities	Phone No.	Room
A		
Academic Senate	763-7167	TG
Admissions & Records	763-5300	R-102
• Adding/Dropping a Class	763-5300	R-102
• Applying for Admissions	763-5300	R-102
• Academic, Administrative & Grade Change Petition	763-5314 or 5317	R-102
• General Petitions	763-5308	R-102
• Credit/No Credit	763-5300	R-102
• Graduation Application	763-5306	R-102
A – E	763-5315	R-102
F – K	763-5320	R-102
L – R	763-5302	R-102
S – Z	763-5322	R-102
• Registration Questions	763-5300	R-102
• Residency Questions	763-5300	R-102
• Transcript Request	763-5309	R-102
A–L	763-5318	R-102
M– Z	763-5321	R-102
• Verification of Enrollment	763-5303	In Person
• Withdraw from College	763-5300	R-102
Allied Health/Health Occupation	763-7170	TG
Assessment	763-5339	C-107
Associated Student Organization (ASO)	763-7200	C-108
Athletics	763-3726	J-202
B		
Basic Skills Office	763-5515	K-006
Bookstore	763-7210	K-102
• Books, Supplies, Catalog, Schedule		
Bridges to Success Center	763-5560	C-108
• K-12 Enrollment		
• Noncredit courses		
Business Office	763-7225	K-126
• Accounts Payable	763-7236	K-126
• Bus Passes and Tokens	763-7225	K-126
• Check Distribution	763-7225	K-126
• Fees Payment and Refund	763-7225	K-126
• Registration Receipt	763-7225	K-126
• Student ID Cards	763-7225	K-126
• Student Parking Permits	763-7225	K-126

Activities	Phone No.	Room
C		
Cafeteria	763-7331	H Bldg
CAHSEE to College	763-5560	C-108
CalWORKs/GAIN	763-7109	TE
Child Development Center	763-3690	Olive & 21st
College Information Center	763-5337	R-100
College Sheriff	763-3600	D-150
• Emergencies	763-3611	D-150
• Locating a Student (emergency)	763-3611	D-150
• Lost & Found	763-3600	D-150
• Parking Enforcement	763-3600	D-150
Compliance Office	763-7066	LRC-257
Continuing Education/Noncredit	763-5560	C-108
Counseling Center	763-7354	H-130
D-F		
Disabled Student Programs & Services	763-3773	E-110
EOPS Programs	763-7097	TR
EOPS/CARE	763-7117	TQ
Financial Aid Lab	763-7082	K-004
Financial Aid Office	763-7082	TN-100
• Financial Aid/ Fee Waiver		
• Loans (Government)		
• Scholarships		
G-I		
GAIN/CalWORKs	763-7331	H-108
Garden Room	763-7331	H-108
Graduation Ceremony	763-7097	TF
Health/Physical Education	763-3730	J-202A
Information Center	763-5337	R-100
• Campus Information		
• Schedules/Catalogs		
• Student ID Card		
International Students	763-5345	R-100
L-P		
Labor Studies	763-7129	L-220
Learning Skills Center	763-3738	C-102
• Learning Skills Computer Lab	763-3738	C-102
• Open Computer Lab	763-7208	C-109

INFORMATION & SERVICES

Activities	Phone No.	Room
• Reading Center	763-3753	C-102
• Tutoring Center	763-3738	C-102
• Writing Center	763-3797	C-100
Library	763-3950	LRC
• Circulation	763-3950	
• Reference Desk	763-3958	
Matriculation	763-5348	K-008
• Assessment	763-5339	C-107
• Orientation	763-5336	R-100
• New Student Counseling	763-7354	H-130
• Prerequisite Clearance	763-5339	C-107
• Challenge Process	763-5339	C-107
Noncredit	763-5560	C-108
Open Computer Lab	763-7208	C-109
PUENTE Program	763-7157	E-107
R-S		
Reading Center	763-3753	C-106
Student Relations/Recruitment/ Outreach	763-5329	K-003
Student Activities	763-7205	C-108
• Awards/Honors	763-7205	C-108
• Campus Clubs	763-7205	C-108
• Notices (Posting on Campus)	763-7205	C-108
• Student Government	763-7200	C-108
Student Employment Center	763-7124	C-107A
• Job Placement	763-7124	C-107A
Student Grievance	763-7066	LRC-257
Student Health Center	763-3764	E-102
• Accidents	763-3764	E-102
• Health Services	763-3764	E-102
T-W		
Tutoring Center	763-3738	C-102
University Transfer Center	763-7154	H-134
Veterans Affairs	763-5305	R-102
Wellness Center	763-3746	E-102
Writing Center	763-3797	C-100

COLLEGE ADMINISTRATION

Name	Phone No.	Room
Dr. Roland Chapdelaine, President	763-7052	A-110
<i>Edward Afana, Acting Dean, Research & Planning</i>	763-7064	A-106
ACADEMIC AFFAIRS		
Dr. Kathleen Burke-Kelly Interim Vice President, Academic Affairs	763-7022	A-104
<i>Vincent Jackson, Dean, Academic Affairs</i>	763-7035	A-119
<i>Cynthia Morley-Mower, Dean, Academic Affairs</i>	763-7074	A-119
ADMINISTRATION		
Dr. Mary Gallagher, Vice President, Administration	763-7040	A-108
<i>Marcus Anglin, College Financial Administrator</i>	763-7225	K-126
<i>Bill Smith, Facilities Manager</i>	763-3612	D-152
STUDENT SERVICES		
Ramon Castillo, Vice President, Student Services	763-7078	TF
<i>Dr. Raul Cardoza, Dean, Enrollment Management</i>	763-5301	R-102
<i>Dr. Theda Douglas, Dean, Student Services</i>	763-7097 or 7098	TF
<i>Ms. Dorothy Smith, Associate Dean, Matriculation/Learning Skills/Recruitment & Outreach/21st Century Grant/ Basic Skills Initiative, Writing Center and Reading Center.</i>	763-5507	K-008
WORKFORCE & ECONOMIC DEVELOPMENT		
Marcy Drummond, Vice President, Workforce & Economic Development	763-7036	E-314
<i>Leticia Barajas, Dean, Academic Affairs</i>	763-7071	E-313

DEPARTMENT HEADS

Name	Phone No.	Room
Admissions & Records – Carolyn Clark	763-5316	R-102
Allied Health – Dr. Rita Weingourt	763-7185	A-347
Art Trades, Fashion – Carole Anderson	763-3640	D-222
Athletics – Dimitri Lagos	763-3728	J-202
Behavioral/Social Sciences/Child Development – Alicia Rodriguez-Estrada	763-3938	F-225K
Bridges to Success – Dr. Allison Tom-Miura	763-3759	C-108
Business/CIS/Computer Applications & Office Technology – Paulette Bailey	763-7258	K-225
Business Office – Marcus Anglin	763-7227	K-126
Child Development Center – Pauline Carrillo	763-3690	Olive & 21st
College Sheriff – Deputy Diane Dodd	763-3600	D-150
Community & Economic Development – Dr. Denise Fairchild	763-3757	C-210
Compliance – Dr. Leita Royal-Burnett	763-7066	LRC-257
Construction, Design & Manufacturing – William D. Elarton	763-3701	B-122
Continuing Education/Noncredit – Leticia Barajas	763-7071	E-314
Cosmetology – Marilyn Maine	763-7139	A-204
Counseling Center – Tom Dawkins	763-7361	H-130
Culinary Arts – Steve Kasmar	763-7331	H-117
Electronics Technology – Eric Chavez	763-3782	E-217
EOPS/CARE – Vacant	763-7097 or 7098	T-Q
Financial Aid Office – Cecilia Kwan	763-7082	TP-100
GAIN/CalWORKs – Linda Cole	763-7109	TE-100
Health/Physical Education – Joseph Ratcliff	763-3730	J-202A
Information Center/Matriculation/21st Century – Dorothy Smith	763-5510	K-007
Labor Center – John McDowell	763-7129	L-220
Language Arts/Humanities – Rodrigo Palacios	763-3923	F-212
Learning Skills Center/ESL – Dr. Ayesha Randall	763-3738	C-102
Library – Vacant	763-3964	L-215
Math – Margaret Murphy	763-7320	K-203D
Noncredit – Dr. Allison Tom-Miura	763-3759	C-108
Physical Plant – Bill Smith	763-3612	D-152
Sciences – Xenia Wright	763-7295	K-405
Transportation – Rudy Serrato	763-3900	F-108K

ACADEMIC DEPARTMENTS & FACULTY

Name	Phone No.	Room
ALLIED HEALTH		
Allied Health &, Health Occupations	7170	TG
Wickman, Yvette	7170	TG
Ashby, Cynthia	7178	TG
Battams, Brian	7172	TG
Chandler, Christine	7194	TG
Davis-Kendrick, Maggie	7181	TG
Jacobs, Loreto	7177	TG
Jenkinson, Deborah	7176	TG
Middleton, Rosemary	7173	TG
Reiley, Joyce	7179	TG
Rodrigues, Angel	7186	TG
Soles, Barbara	7193	TG
Villora, Rosalie	7180	TG
Washington, Carolyn	7174	TG
Weingourt, Dr. Rita	7182	TG
BUSINESS/CAOT/CIS		
Bailey, Paulette	7269	K 225
Amarawansa, Karen	7253	K 225
Business / Management		
Montour, Clifford	7260	K 209
Ahmad, Jamil	7257	K 209
Bessler, Maida	7263	K 260
Endman, James	7252	K 225
Gary, Esq., Karl	7255	K 203b
Gonzalez, Raymond	7259	K 209
Johnson, Ed	7252	K 225
Scudder, Stuart	7252	K 225
Seetao, David	7252	K 225
Shaw, MD	7252	K 225
Sherer, Richard	7265	K 266
Taylor, Melvin	7261	K 209
Taylor, Pamela	7252	K 225
Toure, Yolanda	7252	K 225
Computer Applications/Office Technologies		
Bailey, Paulette	7258	K 209
Baklayan, Shoushan	7264	K 264
Chu, Eleanor	7267	K 306
Haymon, Sharon	7252	K 225
Palacios, Valda	7252	K 225
Thornhill, Dorothy	7266	K 306a
Viramontes, Max	7256	K 208a
Computer Information Systems		
Auciello, Joseph	7268	K 309
Burton, Wanda	7252	K 225
Crunkleton, Joseph	7252	K 225
Emerson, Victoria	7252	K 225
Hahne, Louis	7254	K 309
Kapaku, Okima	7252	K 225
Mata, Antonio	7252	K 325b
Moore, Donald	7252	K 225
Phillips, G. W.	7252	K 225
Proctor, Ernest	7252	K 225
Roberts, Ronald	7252	K 225
Tee, Vincent	7252	K 225

ACADEMIC DEPARTMENTS & FACULTY

Name	Phone No.	Room
COMMUNITY PLANNING & ECONOMIC DEVELOPMENT		
<i>Community Planning &, Econ. Dev.</i>	3757	C 204
<i>Fairchild, Dr. Denise</i>	3760	C 210
<i>Torres, Benjamin</i>	3757	C 210
CONSTRUCTION, DESIGN & MANUFACTURING		
Architecture		
<i>Freeland, David</i>	3677	D 331a
<i>Gallegos, Patricio</i>	3674	B 303a
<i>Garcia, Emmanuel</i>	3673	B 303b
<i>Harichi, Ladan</i>	3700	B 122
<i>Lewis, Jill</i>	3672	D 302b
<i>Murdock, Scott</i>	3673	D 302b
<i>Oliva, Marcela</i>	3676	D 330b
<i>Stenhouse, Douglas</i>	3669	D 331b
Carpentry		
<i>Dunn, Roger</i>	3704	B 104a
<i>Hinoki, Ron</i>	3700	B 122
<i>Hubbard, Larry</i>	3709	B 134b
<i>Lawrence, Reed</i>	3700	B 122
<i>McAndrews, Robert</i>	3700	B 122
<i>Porter, Henry</i>	3700	B 122
<i>Vessella, Thomas</i>	3707	B 134a
<i>Woo, George</i>	3703	B 104b
Electrical		
<i>Brkic, Ferdo</i>	3700	B 122
<i>Burke, Dennis</i>	3740	B 337c
<i>Curtin, Kevin</i>	3700	B 122
<i>Dominguez, John</i>	3700	B 122
<i>Goluzza, Brano</i>	3700	B 122
<i>Jackson, Ronald</i>	3723	B 337a
<i>Karhas, Nicholas</i>	3700	B 122
<i>Lester, John</i>	3721	B 330a
<i>Maalouf, Eli</i>	3700	B 122
<i>Nasrallah, Ghassan</i>	3700	B 122
<i>Nieves, Thomas</i>	3722	B 304b
<i>Pogoler, Lawrence</i>	3720	B 304a
<i>Ramirez, Roberto</i>	3700	B 122
<i>Robinson, David</i>	3718	B 301a
<i>Rogers, Merle</i>	3724	B 351a
<i>Seitz, John</i>	3745	B 337c
<i>Sussman, Daniel</i>	3700	B 122
<i>Takaguchi, Ronald</i>	3700	B 122
<i>Uchida, Hiroshi</i>	3719	B 304a
<i>Wiegand, Carl</i>	3700	B 122
<i>Winston, Ray</i>	3700	B 122
<i>Ying, Supot</i>	3700	B 122
<i>Yow, Yuze</i>	3700	B 122
Machine Shop		
<i>Rauterkus, Peter</i>	3941	F 166b
<i>Shibuya, Steven</i>	3946	F 164j
<i>Vo, Chuong</i>	3945	F 164b
<i>West, P</i>	3700	F 166
<i>York, David</i>	3700	F 166
Plumbing		
<i>Dean, Craig</i>	3710	B 252a
<i>Freidenberger, Karen</i>	3700	B 122
<i>Jones, Larry</i>	3717	B 200c
<i>Lunt, Charles</i>	3700	B 122

Name	Phone No.	Room
<i>Slade, Timothy</i>	3710	B 252a
<i>Swiegart, T</i>	3700	B 122
<i>Weinstock, Stanley</i>	3711	B 202
<i>Yates, Robert</i>	3700	B 122
Refrigeration & Air Conditioning		
<i>Allen, Gene</i>	3700	B 122
<i>Barnett, Craig</i>	3712	B 237c
<i>Brady, Patrick</i>	3700	B 122
<i>Cioffi, Gabriel</i>	3714	B 238a
<i>Corbin, Bobby</i>	3700	B 122
<i>Datis, Angelo</i>	3700	B 122
<i>Dozier, Kelly</i>	3715	B 221c
<i>Espinoza, Albert</i>	3700	B 122
<i>Kahng, Paul</i>	3700	B 122
<i>Needham, Matthew</i>	3743	B 204a
Welding		
<i>Chancy, Che</i>	3949	F 150b
<i>Holley, James</i>	3948	F 156d
<i>Legohn, Lisa</i>	3942	F 156j
<i>Newell, Renee</i>	3944	F 151e
COSMETOLOGY		
<i>McClendon, Jamille</i>	7133	A 215
<i>Aguilar, David</i>	7133	A 215
<i>Maine, Marilyn</i>	7139	A 215a
<i>Chen, Lina</i>	7136	A 204d
<i>Ley, Lidia</i>	7147	A 204
<i>Lopez, Rosa</i>	7145	A 204
<i>Mercado, Dyana</i>	7133	A 204
<i>Monge, Jacqueline</i>	7133	A 204
<i>Robinson, Elton</i>	7138	A 204
<i>Shackelford, Sondra</i>	7140	A 204
<i>Smith, Felicia</i>	7133	A 204
<i>Young, Carolyn</i>	7133	A 204
CULINARY ARTS		
<i>Culinary Arts</i>	7331	H 118
<i>Kasmar, Steven</i>	7332	H 118
<i>Cole, Pamela</i>	7333	H 117
<i>Blanchard, Leroy</i>	7342	H 108
<i>Delrosario, Giovanni</i>	7347	H 131b
<i>Feigenbaum, Susan</i>	7341	H 108
<i>Kanemaki, James</i>	7331	H 118
<i>Lisanti, Jim</i>	7343	H 108
<i>Sims, Eddie</i>	7346	H 131
<i>Spence, Roselyn</i>	7331	H 108
<i>Vachon, Jerry</i>	7331	H 108
Professional Baking		
<i>Damaso, Stacy</i>	7335	H 106
<i>Thompson, Deborah</i>	7351	H 315
<i>Wemischner, Robert</i>	7352	H 315
ELECTRONICS TECHNOLOGY		
<i>Electronics, Technology</i>	3782	E 217
<i>Chavez, Eric</i>	3789	E 217c
<i>McClendon, Jamille</i>	3788	E 217
<i>Campbell, Dr. Robert</i>	3782	E 219c
<i>Cyrus, Shawn</i>	3786	E 219b
<i>Roosta, Soroya</i>	3971	E 305a
<i>Venegas, Rafael</i>	3796	E 311

ACADEMIC DEPARTMENTS & FACULTY

Name	Phone No.	Room
FASHION, VISUAL COMMUNICATIONS & ART TRADES		
<i>Fashion, Center</i>	3640	D 222
<i>Anderson, Carole</i>	3642	D 222
<i>Fernando, Tessie</i>	3640	D 222
Fashion Design		
<i>Adams, Ludmila</i>	3640	D 222
<i>Brand-Njoku, Mary</i>	3655	D 203a
<i>Brooks, Marva</i>	3640	D 222
<i>Coreas, Madeline</i>	3643	D 230a
<i>Cunnigan, Dixie</i>	3640	D 222
<i>Drebskaya, Finna</i>	3650	D 130a
<i>Foral, Dorothy</i>	3640	D 222
<i>Gale, Joyce</i>	3647	D 106a
<i>Glass-Villalobos, Nurit</i>	3657	D 105b
<i>Iaffaldano, Cinzia</i>	3649	D 130b
<i>Jackson, Tiffany</i>	3661	D 332b
<i>Johnson, Deborah</i>	3640	D 222
<i>Kim, Hyein</i>	3644	D 102b
<i>Lee, Aileen</i>	3658	D 102a
<i>Melin, Linda</i>	3640	D 222
<i>Petrie, Iris</i>	3640	D 222
<i>Sapos, Carol</i>	3651	D 133b
<i>Stafford, William</i>	3640	D 222
<i>Thornton, Della</i>	3648	D 106b
<i>Torda, Benito</i>	3640	D 222
<i>Watanabe, Ruth</i>	3645	D 105a
Fashion Merchandising		
<i>Murphy, Diane</i>	3654	D 203a
Tailoring		
<i>Iapaolo, Nino</i>	3640	D 222
Sign Graphics		
<i>Guthrie, Ralph</i>	7367	H 204
Visual Communications		
<i>Evans, George</i>	7372	H 230
<i>Hubbard, Roger</i>	7363	H 220
<i>Mendoza, Laura</i>	7363	H 208
<i>Millar, Norman</i>	7363	H 200
<i>Morris, Fred</i>	7363	H 208
<i>Robles, William</i>	7363	H 208
LABOR CENTER		
<i>Labor, Center</i>	7129	L 220
<i>McDowell, John</i>	7129	L 213
<i>De La Torre, Vivien</i>	7129	L 210
<i>Garcia, Olga</i>	7129	L 220
<i>Siegel, Lou</i>	7129	L 212
<i>Yasuda, Kathleen</i>	7160	L 211
LANGUAGE ARTS / HUMANITIES		
Language Arts/Humanities: Art		
<i>Malone, Annie</i>	3923	F 212
Language Arts/Humanities: English		
<i>Ahmed, Ahmed</i>	3923	F 212
<i>Blake, George</i>	3923	F 212
<i>Dalrymple, Roxann</i>	5511	F 212
<i>Daniels, Jeff</i>	3923	F 212
<i>Dolan, Theresa</i>	5502	F 240a3
<i>Doss, Howaida</i>	3923	F 212
<i>Gangel-Vasquez, Janice</i>	3929	F 212j

Name	Phone No.	Room
<i>Gonzalez, Dr. Michael</i>	7288	K 203g
<i>Gregory, Eric</i>	3923	F 212
<i>Jacobs, Brian</i>	3923	F 212
<i>Kobler, Mark</i>	3923	F 212
<i>Lennon, Frankie</i>	3923	F 212
<i>Mancia, Roberto</i>	7286	K 203f
<i>McCants, Gwen</i>	3923	F 212
<i>Mendez, Armando</i>	3923	F 212
<i>Menzies, Edgar</i>	3923	F 212
<i>Mitchell, Sharis</i>	3923	F 212
<i>Moreno, Lisa</i>	5506	F 240f
<i>Ryder, William</i>	3923	F 212
<i>Shakir-Blackshere, Rashidah</i>	3930	F 212g
<i>Stahl, Lisa</i>	3923	F 212
<i>Villani, Frank</i>	3923	F 212
Language Arts/Humanities: Fine Arts		
<i>Herbert, Pamela</i>	3937	F 240d
<i>Szymanski, Gary</i>	7378	H 236b
<i>Williams, Frank</i>	3923	F 212
Language Arts/Humanities: Humanities		
<i>Parker-Lopez, Carolle</i>	7285	K 203f
<i>Tropf, Ralph</i>	3923	F 212
Language Arts/Humanities: Music		
<i>Canon, Sherri</i>	3668	D 300a
<i>Ray, Eric</i>	3923	F 212
<i>White, Molly</i>	5377 x 4012	D 300a
Language Arts/Humanities: Philosophy		
<i>Egan, Richard</i>	3923	F 212
<i>Sargeant, Mark</i>	3923	F 212
Language Arts/Humanities: Spanish		
<i>Buscaglia, Renatta</i>	7274	K 366b
<i>Drake, Millie</i>	3923	F 212
<i>Linares, Manuel</i>	3923	F 212
<i>Quinones, Hernan</i>	7291	K 366a
<i>Ross, Rose</i>	3923	F 212
Language Arts/Humanities: Spanish/French		
<i>Palacios-Ochoa, Rodrigo</i>	7289	K 364a
Language Arts/Humanities: Speech		
<i>Borne, Alvin</i>	3923	F 212
<i>Glavan, John</i>	3931	F 212a
<i>McNamara, Catherine</i>	3923	F 212
<i>Mock, Jearold</i>	3923	F 212
<i>Wood, Deirdre</i>	3926	F 212h
Language Arts/Humanities: Theater		
<i>Harmetz, E.</i>	7290	K 366b
LEARNING SKILLS		
<i>Learning Skills Center</i>	3738	C 102
<i>Randall, Ayesha</i>	3739	C 100d
<i>Anketell, Christina</i>	3741	C 100c
<i>Armstrong, Maria</i>	3698	C 100c
<i>Cole, Valerie</i>		
<i>Grunbaum, Dorien</i>	7284	K 203e
<i>Harley, Norma</i>		
<i>Iniguez, Noe</i>	3738	C 104
<i>Kinyon, Kindra</i>	7283	C 100c
<i>LeBorg, Regina</i>		
<i>Le Veque, Victoria</i>	3938	C 102
<i>Nwoko, John</i>	3738	C 102a
<i>Pham, Minh</i>	3738	C 104
<i>Porter, Alfred</i>	3738	C 102

ACADEMIC DEPARTMENTS & FACULTY

Name	Phone No.	Room
------	-----------	------

LIBRARY SCIENCE

Nitsch, Lisa	3978	LRC
Samuel, Judith	3959	LRC

MATHEMATICS

Mathematics, Dept.	7330	K 203d
Murphy, Margaret	7320	K 203d
Bakman, Dr. Anna	7299	K 203h
Lee, Dr. Kuen	7314	K 203a
Light, Eugene	7301	K 203h
Liu, Hsiao-Ling	7315	K 203a
Meftagh, Tayebbeh	7319	K 203b

MORTGAGE FINANCE

Mortgage Finance, Program	3757	C 204
---------------------------	------	-------

NONCREDIT/CONTINUING EDUCATION

Tom-Miura, Dr. Allison	3759	C 108
------------------------	------	-------

PHYSICAL EDUCATION/ATHLETICS

Athletics, Physical Education	3726	J 202
Ratcliff, Joseph	3730	J 202a
Hale, Tracy	3727	J 202
Browne, James	5524	J 204
Budinger, John	5377 x 4069	J 213
De Franco-Browne, Diane	3732	J 210
Delzeit, Linda	3733	L 270
Lagos, Dimitri	3728	J 202
Orozco, Oscar	3734	G 104
Pfiffner, Brian	5377 x 4076	J 202
Physical Education, Athletics	3726	J 202
Sullivan, Dr. Sally	3731	J 210
Wagenbach, Michael	3729	J 203
Wells, Richard	3737	J 201

SCIENCES**Sciences: Biology**

Avila, Luis	7300	K 203d
Brockmann, Erika	7306	K 402
Denton, Dr. Timothy	7297	K 423c
Gbonegun, Olu	7295	K 405
Kunarak, Sanya	7310	K 203d
Lavinger, Steve	7295	K 405
Neddermeyer, Karl	7295	K 405
Olsen, Bruce	7295	K 405
Pantastico-Caldas, Dr. Marissa	7298	K 423f
Pappas, Nick	7295	K 405
Ramaraj, Pandurangan	7295	K 405
Shank, Barbara	7295	K 405
Simpson-Rogers, Nii	7329	K 203d
Wright, Xenia	7296	K 405a

Name	Phone No.	Room
------	-----------	------

Sciences: Chemistry

Aje, Dr. Henry	7295	K 405
Darmanyan, Dr. Pavel	7295	K 405
Diaz, Dr. Martin	7302	K 423b
Harutunian, Dr. Vahak	7317	K 423e
Houban, Dr. Karl	7324	K 423h
Jeffress, David	7304	K 401
Powers, Dr. Richard	7295	K 405
Ruiz-Silva, Dr. Beatriz	7311	K 423f

Sciences: Geology

Colazas, Xenophon	7295	K 405
-------------------	------	-------

Sciences: Microbiology

Hosseini, Mansour	7295	K 405
Wong, Ricky	7313	K 423b

Sciences: Physical Geography

Landau, Dr. Daniel	7295	K 405
Schwartz, Gregory	7295	K 405

Sciences: Physics

Goodman, Todd	7295	K 405
Parkin, Steve	7295	K 405

Sciences: Physics/Astronomy

Moreno, Dr. Miquel	7322	K 423g
Padilla, Fred	7323	K 423h
Santoianni, Donald	7307	K 403

Sciences: Physics/Engineering

El Tawansy, Mohamed	7321	K 423g
---------------------	------	--------

Sciences: Process Plant Technology

Madyun, Renee	7318	K 423e
Sutton III, Dr. Cash	7295	K 405

Sciences: Solid Waste Mgmt.

Blount, Paul	7295	K 405
--------------	------	-------

Sciences: Supply Water

Amir-Teymoori, Abbas	7295	K 405
----------------------	------	-------

Sciences: Wastewater

Abd El Aal, Mohamed	7295	K 405
Abkian, Varout	7295	K 405

SOCIAL & BEHAVIORAL SCIENCES

Chen, Shirley	5513	F 225
Huld, Philip	5504	F 225a3

Social & Behavioral Sciences: Child Development

Babb, Jing	3954	H 350
Maina, Dr. Gathoni	3953	H 350
Vega, Cecelia	3986	H 350

Social & Behavioral Sciences: History

Rodriguez-Estrada, Alicia	5513	F 225k
Jackson, Diana	5503	F 225f
Robinson, Thurman	3932	F 225g

Social & Behavioral Sciences: Political Science

Vaden, Dr. Bradley	3927	F 240a2
--------------------	------	---------

Social & Behavioral Sciences: Psychology

Essex, Dr. Robert	3933	F 225j
Koritzke, Leslee	5505	F 225a2

Social & Behavioral Sciences: Sociology

McClain, Dr. Freddie	3936	F 225a4
----------------------	------	---------

ACADEMIC DEPARTMENTS & FACULTY

Name	Phone No.	Room
STUDENT SERVICES - COUNSELORS		
<i>Abraham, Angeles</i>	7117	TR 101
<i>Ahn, Inhae</i>	7156	R 100
<i>Almada, Christina</i>	7360	H 130A
<i>Brent, Lourdes</i>	7117	TQ 101
<i>Bukasa, Lorna</i>	7117	TQ 104
<i>Burnett, Maurice</i>	7358	R 100
<i>Campbell, Deborah</i>	7359	H 130B
<i>Cole, Linda</i>	7109	TE 103
<i>Esparza, David</i>	7158	H 134
<i>Gray, Kamale</i>	5342	R 100
<i>Hopper, Michael</i>	7109	TE 101
<i>Hosseini, Ashraf</i>	7157	E 107
<i>Johnson-Taylor, Chini</i>	7366	R 100
<i>Madrid, George</i>	7360	H 130D
<i>Munoz, Ana</i>	7117	TQ 105
<i>Rosario, Gliceria</i>	7117	TQ 102
<i>Skinner, Kyle</i>	7117	TQ 106
<i>Tishler, Sheila</i>	7097	R 100

Name	Phone No.	Room
TRANSPORTATION		
<i>Transportation</i>	3900	F 114
<i>Serrato, Rudy</i>	3901	F 114
<i>Scherb, Eva</i>	3902	F 114
<i>Chung, Peter</i>	3909	F 106d
<i>Encinas, Dan</i>	3939	F 132
<i>Goyn, Bruce</i>	3900	F 114
<i>Grissett, Robert</i>	3900	F 114
<i>Guerra, Ricardo</i>	3900	F 114
<i>Marroquin, Manuel</i>	3914	F 116b
<i>McFall, Thomas</i>	3917	F 122
<i>Spear, George</i>	3907	F 104
<i>Uribe, John</i>	3910	F 108a
<i>Williams, Terry</i>	3906	F 102
<i>Woo, William</i>	3920	F 128
Collision Repair		
<i>Ferre, Brian</i>	3912	F 110g
<i>Morago, Fred</i>	3916	F 120b
<i>Muradian, Sarkis</i>	3916	F 120b
<i>Singh, Santock</i>	3900	F 110a
Diesel and Related Technology		
<i>Cavanaugh, John</i>	3905	F 100a
<i>Guerra, Jesus</i>	3919	F 126a
Motorcycle Repair		
<i>Price, Robert</i>	3918	F 124a

Public Transportation to Los Angeles Trade-Technical College

Metro Rail/Bus Lines (www.mta.net):

Access from:

Metro Rail	Blue, Gold, Green, Orange and Red Lines	Blue Line Grand Station
2/302	Downtown Los Angeles - Pacific Palisades via Sunset Bl	Broadway/Venice
4	Downtown Los Angeles - West Los Angeles - Santa Monica via Santa Monica Bl	Broadway/Venice
10	Downtown Los Angeles - West Hollywood via Temple St & Melrose Av	Main/Venice
14	Downtown Los Angeles - Beverly Hills via Beverly Bl	Grand/Venice
20	Downtown LA - Santa Monica via Wilshire Bl	Red Line>Blue Line>Grand Station
33/333	Downtown LA - Santa Monica via Venice Bl	Red Line>Blue Line>Grand Station
35/335	Downtown Los Angeles - Fairfax/Washington via Washington Bl	Broadway/Venice
37	Downtown Los Angeles - Fairfax/Washington via Adams Bl	Grand/Venice
38	17th/Broadway - Fairfax/Washington via W. Jefferson Bl	Grand/Jefferson
40	South Bay Galleria - Union Station via Hawthorne Bl, Crenshaw Bl & ML King Bl	Broadway/Washington
42	LAX - Downtown LA via LAX City Bus Center, LaTijera Bl, Stocker St & M.L.King Bl	Broadway/Washington
45	Lincoln Heights - Rosewood via Broadway	Broadway/Washington
48	Downtown Los Angeles-Avalon Station via Main St & South San Pedro St	Main/Venice
55/355	Downtown LA - Imperial Station via Compton Av	Grand Station
66/366	Wilshire Center - Montebello via 8th St & Olympic Bl	Red Line>Blue Line>Grand Station
68/84	West Los Angeles - Montebello via Washington Bl & Cesar Chavez Av	Red Line>Blue Line>Grand Station
78/79/378	Arcadia - Los Angeles via Huntington Dr & Las Tunas Dr	Olive/Venice-18 th
83	Eagle Rock - Downtown LA via York	Hill-Main/Venice
90/91	Downtown LA - Sunland via Glendale Av, Foothill Bl	Hill/Venice
94	Downtown Los Angeles-Sylmar Station via Hill St & San Fernando Rd	Hill/Venice
96	Downtown Los Angeles-Sherman Oaks via Griffith Pk Dr & Riverside Dr	Olive-Grand/Venice
439	LAX/Aviation Station - Downtown LA/Union Station via LAX, Westchester, etc.	Red Line>Blue Line>Grand Station
442	Hawthorne - Downtown LA via Hawthorne Bl, La Brea Av, Manchester Bl., etc.	Red Line>Blue Line>Grand Station
444	Rancho Palos Verdes - Downtown LA via Hawthorne Bl-Harbor /I-110 Fwy	Red Line>Blue Line>Grand Station
445	San Pedro - Union Station via Pacific Av, First St, Harbor Beacon Park Ride Lot, etc.	Red Line>Blue Line>Grand Station
446/447	San Pedro - Downtown LA/Union Station via Pacific Av., Avalon Bl, etc.	Red Line>Blue Line>Grand Station
484	Metro Local and Express (Pomona-Downtown LA via Valley Bl & El Monte Busway)	Olive/Venice-18 th
485	Metro Local and Express (Altadena-Downtown LA via Lake Av & El Monte Busway)	Olive/Venice-18 th
487/489	Sierra Madre Villa Gold Line Station-Downtown LA -- Temple City - Downtown LA	Red Line>Blue Line>Grand Station
490	Metro Local and Express (Pomona-Downtown LA via Ramona Bl & El Monte Busway)	Olive/Venice-18 th
603	Rampart Bl. - Hoover St-Allesandro St. - Colorado St.	Grand/Washington
730	Metro Rapid (Downtown LA-Pico Rimpau via Pico Bl)	Broadway/Temple
745	Metro Rapid (Downtown Los Angeles-Harbor Freeway Station via Broadway)	Broadway/Washington
794	Metro Rapid (Downtown Los Angeles-Burbank Station via San Fernando RD, Brand Bl)	Hill/Venice

Other transit lines that stop within a few blocks of the college include:

- . *LADOT DASH and Commuter Express (<http://www.ladottransit.com/>)*
- . *Foothill Transit (<http://www.foothilltransit.org/>)*
- . *Montebello Bus Lines (<http://www.cityofmontebello.com/depts/transit/bus/default.asp>)*
- . *Santa Monica Municipal Bus Lines (<http://www.bigbluebus.com/home/index.asp>)*
- . *Torrance Transit (<http://www.ci.torrance.ca.us/128.htm>)*

INDEX

A	
Ability to Benefit Test	50
Academic Freedom	77
Academic Standards	77
Accuracy Statement	77
Adding Classes	13
Admission And Records	84
Application for Admission	55
Apprenticeship Education	74
Assessment Test	11
Attendance	77
Auditing Classes	8, 13
B	
Basic Skills Enrollment Limitation	13
BOGF Waiver	51
Bridges to Success Center	84
C	
C.A.R.E.	84
Campus Offices & Services	84
Campus Security Act/The Cleary Act	83
Cancelled Classes	13
Career Center	84
Child Development Center	84
Class Conflict	13
Class Listing	20
Honors	47
On-Line Classes	70
Cooperative Education	73
Apprenticeship Education	74
Instructional Television	75
Co-requisites	12
Concurrent Enrollment	13
Conduct Expected of Students	77
Counseling Services	84
Course Repetition	13
Crime Reporting Procedures	82
D	
Disabled Student Program	84
Disciplinary Action	82
Diversity	77
Dropping Classes	13
Drug-Free Workplace	78
E	
E-Mail Accounts	78
Educational Environment Policy	78

Educational Programs	19
Emergency Information	78
Employment Center	85
English Proficiency	79
Enrollment Process	4
Extended Opportunity Program	84
F	
Family Education Rights and Privacy Act	78
Fee Exemption - K-12	78
Fees	8
Financial Aid	84
Application Process	49
ATB Test	50
BOGF Waiver	51
Freedom of Speech Area	78
G	
GAIN /CALWORKS	85
Grades and Grade Changes	79
Graduation	
Plan A General Education	15
Plan B General Education	16
CSU General Education	17
IGETC General Education	18
Grievance Procedures	82
H	
Health Center	85
Hope Scholarship Tax Credit	79
I	
Information Center	85
International Student Admission Office	13, 85
Instructional Resource Lab (IRL)	48
ITV - The Weekend College	75
L	
Learning Skills Center	48
Library	85
Limited English Proficiency	79
M	
Matriculation	85
N	
Non-Citizen Admission	13
Nondiscrimination Policy	80

O	
Ombudsperson	86
On-line classes	70-72
Open Enrollment	80
Open Computer Lab	48
Orientations	6
P	
Parking	14, 80
Pass/No Pass	78
Prerequisites	12
Public Transportations	94
Puente Program	85
R	
Records and Directory Information	82
Registration by Proxy	14
Register by Internet	7
Resolution Process	76
Right to Know	82
S	
Sexual Assault	80
Smoking Policy	80
Social Security Numbers	80
Standards of Student Conduct	81
Steps to Enroll	5
Student Activities Office	85
Student Records & Directory Information	82
Student Resolution Process	76
Student Rights and Responsibilities	82
Study Load	14
T	
Transcripts	87
Tutoring Center	78
U	
Umoja Program	85
University Transfer Center	85
V	
Verifications of Enrollment	83
Veterans	14
Viewing Your Records	83
Vision and Mission of LATTC	3
W	
Writing Center	78

SPRING 2010 FINAL EXAM SCHEDULE

Final examinations are required of all classes and are required to be given within the designated final exam period; a two-hour period is scheduled for each examination.

The date of your final examination is determined by the first day and the first hour your class meets.

Final examinations must be held on the day and time scheduled and in your regularly assigned classroom.

Short-term Classes – Classes that are scheduled less than 15 weeks will have their final exam at the normal class time on the last day of instruction.

Weekend Classes – Classes that are scheduled on Friday only or Saturday only will have their final exam at the normal class time on Friday, June 4 or Saturday, June 5.

Evening Classes – Classes that meet at 3:30 p.m. or later will have their final exam at the normal class time on the last day of instruction.

For class times not listed or in case of conflicts or make-up exams – please see instructor. Instructors will need to consult with their Department Chair and Area Dean to determine final exam times for classes with start times that do not coincide with the standard time blocks listed below.

Classes meeting on MWF or Daily: If class meets between the beginning time and ending time as shown below

Class Meeting Times	Final Exam Day	Final Exam Date	Final Exam Meeting Times
7:00 a.m. - 7:55 a.m.	Monday	Jun 7	7:00 a.m. - 9:00 a.m.
8:00 a.m. - 8:55 a.m.	Wednesday	Jun 2	8:00 a.m. - 10:00 a.m.
9:00 a.m. - 9:55 a.m.	Friday	Jun 4	9:00 a.m. - 11:00 a.m.
10:00 a.m. - 10:55 a.m.	Monday	Jun 7	10:00 a.m. - 12:00 p.m.
11:00 a.m. - 11:55 a.m.	Wednesday	Jun 2	11:00 a.m. - 1:00 p.m.
12:00 p.m. - 12:55 p.m.	Friday	Jun 4	12:00 p.m. - 2:00 p.m.
1:00 p.m. - 1:55 p.m.	Monday	Jun 7	1:00 p.m. - 3:00 p.m.
2:00 p.m. - 2:55 p.m.	Wednesday	Jun 2	2:00 p.m. - 4:00 p.m.
3:00 p.m. - 3:55 p.m.	Friday	Jun 4	3:00 p.m. - 5:00 p.m.

Classes meeting on MW: If class meets between the beginning time and ending time as shown below

Class Meeting Times	Final Exam Day	Final Exam Date	Final Exam Meeting Times
7:00 a.m. - 7:55 a.m.	Monday	Jun 7	7:00 a.m. - 9:00 a.m.
8:00 a.m. - 8:55 a.m.	Wednesday	Jun 2	8:00 a.m. - 10:00 a.m.
9:00 a.m. - 9:55 a.m.	Monday	Jun 7	9:00 a.m. - 11:00 a.m.
10:00 a.m. - 10:55 a.m.	Wednesday	Jun 2	10:00 a.m. - 12:00 p.m.
11:00 a.m. - 11:55 a.m.	Monday	Jun 7	11:00 a.m. - 1:00 p.m.
12:00 p.m. - 12:55 p.m.	Wednesday	Jun 2	12:00 p.m. - 2:00 p.m.
1:00 p.m. - 1:55 p.m.	Monday	Jun 7	1:00 p.m. - 3:00 p.m.
2:00 p.m. - 2:55 p.m.	Wednesday	Jun 2	2:00 p.m. - 4:00 p.m.
3:00 p.m. - 3:55 p.m.	Monday	Jun 7	3:00 p.m. - 5:00 p.m.

Classes meeting on TTh: If class meets between the beginning time and ending time as shown below

Class Meeting Times	Final Exam Day	Final Exam Date	Final Exam Meeting Times
7:00 a.m. - 7:55 a.m.	Tuesday	Jun 1	7:00 a.m. - 9:00 a.m.
8:00 a.m. - 8:55 a.m.	Thursday	Jun 3	8:00 a.m. - 10:00 a.m.
9:00 a.m. - 9:55 a.m.	Tuesday	Jun 1	9:00 a.m. - 11:00 a.m.
10:00 a.m. - 10:55 a.m.	Thursday	Jun 3	10:00 a.m. - 12:00 p.m.
11:00 a.m. - 11:55 a.m.	Tuesday	Jun 1	11:00 a.m. - 1:00 p.m.
12:00 p.m. - 12:55 p.m.	Thursday	Jun 3	12:00 p.m. - 2:00 p.m.
1:00 p.m. - 1:55 p.m.	Tuesday	Jun 1	1:00 p.m. - 3:00 p.m.
2:00 p.m. - 2:55 p.m.	Thursday	Jun 3	2:00 p.m. - 4:00 p.m.
3:00 p.m. - 3:55 p.m.	Tuesday	Jun 1	3:00 p.m. - 5:00 p.m.

400 West Washington Blvd.
 Los Angeles, California 90015-4181
www.lattc.edu



Phone: (213) 763-7000
 TDD: (213) 763-5375
 Fax: (213) 763-5393

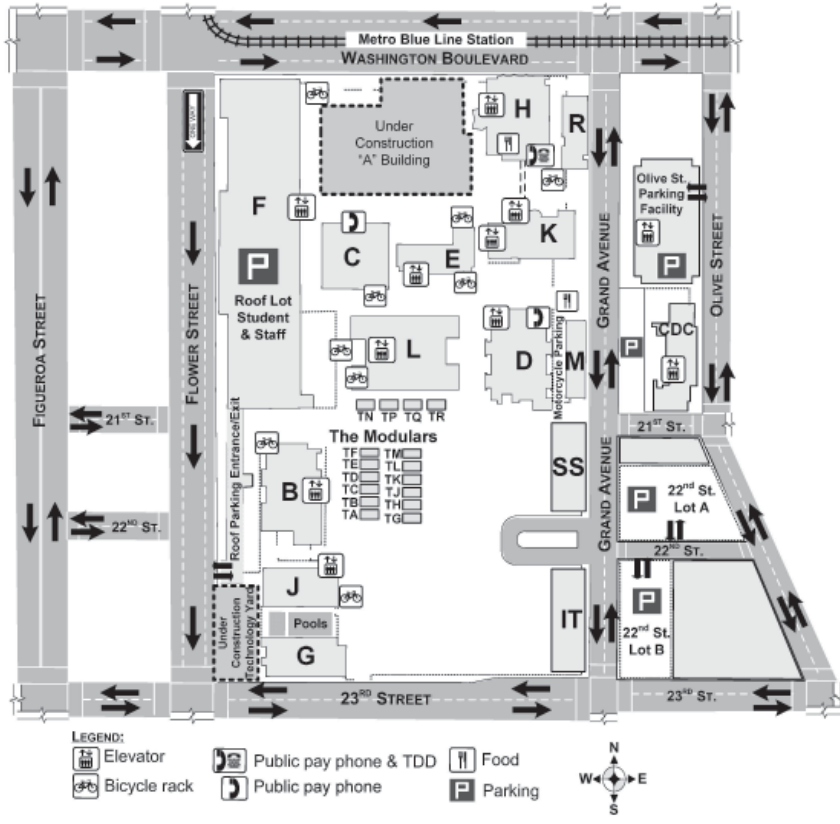

LEGEND:
 Elevator, Bicycle rack, Public pay phone & TDD, Public pay phone, Food, Parking

- B BUILDING**
 Apprenticeship/Coop. Ed.
 Construction Technologies
- C BUILDING**
 Community & Economic Development
 Copy Center
 Learning Skills Center
 Mail Room
 Student Activities/ASO
 Writing Center
- CDC BUILDING**
 Child Development Center
- D BUILDING**
 Architecture Technology
 Art Trades/Fashion
 College Sheriff
 Physical Plant Office
- E BUILDING**
 Disabled Student Programs & Services
 Electronics Technology
 School Relations
 Student Health Center
 Worksource Center
- F BUILDING**
 Automotive Technologies
 Machine Shop CNC
 Receiving
 Welding Program
- G BUILDING**
 Gymnasium
 Men's & Women's
- H BUILDING**
 Art Trades
 Cafeteria
 Counseling Center
 Culinary Arts
 Garden Room
 Media Services
- IT BUILDING**
 Behavioral/Social Sciences
 Language Arts/Humanities
 Mathematics
- J BUILDING**
 Athletics
 Health/Physical Education
- K BUILDING**
 Bookstore
 Business Administration
 Computer Applications & Office Technology
 Computer Information Systems
 Science
- L BUILDING**
 Fitness Center
 Labor Center
 Library
- M BUILDING**
 Jefferson High School
 Webmaster
 Physical Plant Shops
- R BUILDING**
 Cosmetology
- SS BUILDING**
 Academic Affairs
 Administrative Offices
 Admissions & Records
 Assessment Center
 Bridges to Success Center
 Business Office
 CalWorks/GAIN
 Career Center
 Compliance Office
 Continuing Education
 EOPS/CARE
 Financial Aid
 Information Center
 International Student Program
 Matriculation
 Non-credit
 Personnel/Payroll
 PUENTE Program
 School Relations
 Student Employment Center
 Student Services
 University Transfer Center
 Veterans Services
 Workforce & Econ. Dev.
- THE MODULARS**
 Allied Health/Health Occupations
 Temporary Classrooms



10/16/09-ty

Please note: At the time of publication, current information was used. Construction demands will create changes and information will always be available at the College Sheriff's Office, D150, (213) 763-3600, 24 hours a day, 7 days per week. LATTC provides adequate parking for students, staff and visitors. However, since demand is high during the first three weeks of Fall and Spring semesters, overflow parking will be available in the East lot of the LA Mart at 1933 S. Broadway. These spaces are accessible from Broadway or Main Streets just south of Washington. The LA Mart East lot offers free parking to students with a valid college parking permit for the first three weeks of the Fall and Spring semesters only. Beginning with the fourth week, students must use other designated college lots.



Non-Profit Org
US Postage
PAID
Los Angeles, CA
Permit No. 33366

Los Angeles Trade - Technical College
400 West Washington Blvd.
Los Angeles, California 90015

Ph. (213) 763-7000
TDD (213) 763-5375

www.lattc.edu



Materials available in alternate media format upon request.
Cover design by Visual Communications student Alex Soto.